

**SIEMENS**

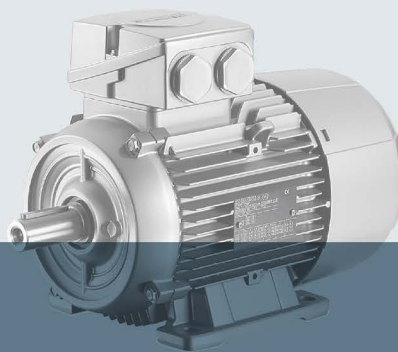

# SINAMICS

## SINAMICS G120 low voltage converters

Chassis devices with CU240B-2 and CU240E-2 Control Units

Operating instructions

Edition

01/2016



# SIEMENS

## SINAMICS

### SINAMICS G120 Converter with the CU240B-2 and CU240E-2 Control Units

#### Operating Instructions

#### Changes in this manual

---



Fundamental safety instructions	1
Introduction	2
Description	3
Installing	4
Commissioning	5
Advanced commissioning	6
Backing up data and series commissioning	7
Corrective maintenance	8
Alarms, faults and system messages	9
Technical data	10
Appendix	A

Edition 01/2016, Firmware V4.7 SP6

## Legal information

### Warning notice system

This manual contains notices you have to observe in order to ensure your personal safety, as well as to prevent damage to property. The notices referring to your personal safety are highlighted in the manual by a safety alert symbol, notices referring only to property damage have no safety alert symbol. These notices shown below are graded according to the degree of danger.

 <b>DANGER</b>
indicates that death or severe personal injury <b>will</b> result if proper precautions are not taken.
 <b>WARNING</b>
indicates that death or severe personal injury <b>may</b> result if proper precautions are not taken.
 <b>CAUTION</b>
indicates that minor personal injury can result if proper precautions are not taken.
<b>NOTICE</b>
indicates that property damage can result if proper precautions are not taken.

If more than one degree of danger is present, the warning notice representing the highest degree of danger will be used. A notice warning of injury to persons with a safety alert symbol may also include a warning relating to property damage.

### Qualified Personnel

The product/system described in this documentation may be operated only by **personnel qualified** for the specific task in accordance with the relevant documentation, in particular its warning notices and safety instructions. Qualified personnel are those who, based on their training and experience, are capable of identifying risks and avoiding potential hazards when working with these products/systems.

### Proper use of Siemens products

Note the following:

 <b>WARNING</b>
Siemens products may only be used for the applications described in the catalog and in the relevant technical documentation. If products and components from other manufacturers are used, these must be recommended or approved by Siemens. Proper transport, storage, installation, assembly, commissioning, operation and maintenance are required to ensure that the products operate safely and without any problems. The permissible ambient conditions must be complied with. The information in the relevant documentation must be observed.

### Trademarks

All names identified by ® are registered trademarks of Siemens AG. The remaining trademarks in this publication may be trademarks whose use by third parties for their own purposes could violate the rights of the owner.

### Disclaimer of Liability

We have reviewed the contents of this publication to ensure consistency with the hardware and software described. Since variance cannot be precluded entirely, we cannot guarantee full consistency. However, the information in this publication is reviewed regularly and any necessary corrections are included in subsequent editions.



# Changes in this manual

## Notable changes since the 04/2015 edition of the manual

### New hardware

- New Power Module – PM240-2, FSF

 Power Module (Page 31)

### New functions in firmware V4.7 SP6

- Evaluation of a PT1000 motor temperature sensor

 Motor temperature monitoring using a temperature sensor (Page 265)

- Revision of the thermal motor models: p0612 bit 08, 09 and 12

 Protecting the motor by calculating the motor temperature (Page 269)

- Support for 1PC1 induction motors

 Supported motor series (Page 49)

- Changing the quick commissioning in the "Standard Drive Control" application class:

The motor data identification is no longer permanently set to p1900 = 12; instead, users select the appropriate motor data identification.

Factory setting: p1900 = 2.

 Standard Drive Control (Page 154)

 Standard Drive Control (Page 135)

You can find an overview of all new and modified functions in firmware V4.7 SP6:

 New and extended functions (Page 477)

### Corrections



- The "Moment of inertia estimator" function has been released for all permitted motors.

 Moment of inertia estimator (Page 254)

- It is not permissible that the output of the friction characteristic r3841 is interconnected with p1511 or with p1513.

 Friction characteristic (Page 252)

**Additional revised descriptions**

- Autotuning the PID technology controller
  -  PID technology controller (Page 308)
- Commissioning
  -  Commissioning (Page 127)

# Table of contents

	Changes in this manual.....	5
<b>1</b>	<b>Fundamental safety instructions .....</b>	<b>15</b>
1.1	General safety instructions .....	15
1.2	Safety instructions for electromagnetic fields (EMF) .....	19
1.3	Handling electrostatic sensitive devices (ESD) .....	19
1.4	Industrial security .....	20
1.5	Residual risks of power drive systems.....	21
<b>2</b>	<b>Introduction.....</b>	<b>23</b>
2.1	About the Manual.....	23
2.2	Guide through the manual .....	24
<b>3</b>	<b>Description.....</b>	<b>27</b>
3.1	Identifying the converter.....	27
3.2	Overview of Control Units .....	29
3.3	Power Module .....	31
3.3.1	Power Modules in degree of protection IP20 and with push-through system .....	31
3.3.2	Power Module in IP55 degree of protection / UL Type 12.....	34
3.4	Components for the Power Modules .....	35
3.4.1	Accessories for installation and shielding .....	35
3.4.2	Line filter .....	36
3.4.3	Line reactor .....	38
3.4.4	Output reactor .....	40
3.4.5	Sine-wave filter .....	43
3.4.6	Braking resistor.....	45
3.4.7	Brake Relay .....	48
3.4.8	Safe Brake Relay.....	48
3.5	Supported motor series.....	49
3.6	Tools to commission the inverter .....	51
<b>4</b>	<b>Installing .....</b>	<b>53</b>
4.1	Overview of the inverter installation.....	53
4.2	Connecting inverters in compliance with EMC .....	54
4.2.1	EMC-compliant connection of the converter.....	54
4.2.2	Avoiding electromagnetic influence (EMI) .....	54
4.2.3	Laying EMC-compliant cables .....	57
4.3	Installing reactors, filters and braking resistors .....	58
4.4	Installing Power Modules.....	60
4.4.1	Basic installation rules .....	60

4.4.2	Dimensioned drawings, drilling dimensions for the PM240-2 Power Module, IP20 .....	62
4.4.3	Dimensioned drawings, drilling dimensions for the PM240-2 Power Module, PT inverter .....	64
4.4.4	Dimensioned drawings, drilling dimensions for the PM240 Power Module, FSA ... FSF .....	66
4.4.5	Dimensioned drawings, drilling dimensions for the PM240 Power Module, FSGX .....	68
4.4.6	Dimensioned drawings, drilling dimensions for the PM230 Power Module, IP20 .....	69
4.4.7	Dimensioned drawings, drilling dimensions for the PM230 Power Module, PT inverter .....	71
4.4.8	Dimensioned drawings, drilling dimensions for the PM250 Power Module .....	73
4.4.9	Dimensioned drawings, drilling dimensions for the PM260 Power Module .....	75
4.4.10	Dimensioned drawings, drilling dimensions for the PM340 Power Module .....	76
4.5	Connecting the line supply, motor, and inverter components .....	77
4.5.1	Permissible line supplies .....	77
4.5.2	Dimensioning the protective conductor .....	80
4.5.3	Connecting the inverter .....	82
4.5.4	Connecting a motor holding brake .....	86
4.5.4.1	Mounting and connecting the brake relay .....	87
4.5.4.2	Mounting and connecting the brake relay .....	87
4.5.4.3	Technical data of the brake relay? .....	88
4.5.4.4	Install and connect Brake Relay - PM240, PM250, PM260 Power Modules .....	88
4.5.4.5	Install and connect the Brake Relay - PM240-2 Power Module .....	89
4.6	Installing Control Unit .....	90
4.6.1	Overview of the interfaces .....	91
4.6.2	Fieldbus interface allocation .....	92
4.6.3	Terminal strips on CU240B-2 Control Units .....	93
4.6.3.1	Factory setting of the CU240B-2 interfaces .....	95
4.6.3.2	Default settings of the CU240B-2 interfaces .....	97
4.6.4	Terminal strips on CU240E-2 Control Units .....	100
4.6.4.1	Factory setting of the CU240E-2 interfaces .....	102
4.6.4.2	Default settings of the CU240E-2 interfaces .....	104
4.6.4.3	Safety input .....	114
4.6.5	Wiring the terminal strip .....	115
4.6.6	Monitoring the temperature of the braking resistor .....	116
4.7	Connecting the inverter to the fieldbus .....	118
4.7.1	PROFINET .....	119
4.7.1.1	What do you need for communication via PROFINET? .....	120
4.7.1.2	Integrating inverters into PROFINET .....	121
4.7.1.3	Configuring communication to the control .....	121
4.7.1.4	Installing GSDML .....	122
4.7.2	PROFIBUS .....	123
4.7.2.1	What do you need for communication via PROFIBUS? .....	123
4.7.2.2	Integrating inverters into PROFIBUS .....	124
4.7.2.3	Configuring the communication using SIMATIC S7 control .....	124
4.7.2.4	Installing the GSD .....	125
4.7.2.5	Setting the address .....	125
<b>5</b>	<b>Commissioning .....</b>	<b>127</b>
5.1	Commissioning guidelines .....	127
5.2	Preparing for commissioning .....	128
5.2.1	Collecting motor data .....	128
5.2.2	Inverter factory setting .....	129

5.3	Quick commissioning using the BOP-2 operator panel .....	131
5.3.1	Inserting the BOP-2 .....	131
5.3.2	Overview .....	132
5.3.3	Starting quick commissioning .....	133
5.3.4	Standard Drive Control .....	135
5.3.5	Dynamic Drive Control .....	138
5.3.6	Expert .....	141
5.3.7	Identifying the motor data and optimizing the closed-loop control .....	145
5.4	Quick commissioning with a PC. ....	147
5.4.1	Creating a project .....	147
5.4.2	Transfer inverters connected via USB into the project .....	147
5.4.3	Go online and start quick commissioning .....	150
5.4.4	Carrying out quick commissioning .....	151
5.4.4.1	Overview .....	151
5.4.4.2	Standard Drive Control .....	154
5.4.4.3	Dynamic Drive Control .....	155
5.4.4.4	Expert .....	156
5.4.4.5	Identify motor data .....	159
5.5	Restoring the factory setting .....	162
5.5.1	Resetting the safety functions to the factory setting .....	163
5.5.2	Restore the factory settings (without safety functions) .....	166
<b>6</b>	<b>Advanced commissioning .....</b>	<b>169</b>
6.1	Overview of the inverter functions .....	169
6.2	Inverter control .....	171
6.2.1	Switching the motor on and off .....	171
6.2.2	Adapt the default setting of the terminal strip .....	173
6.2.2.1	Digital inputs .....	174
6.2.2.2	Safety-related input .....	176
6.2.2.3	Digital outputs .....	177
6.2.2.4	Analog inputs .....	178
6.2.2.5	Analog outputs .....	182
6.2.3	Inverter control using digital inputs .....	185
6.2.4	Two-wire control: method 1 .....	186
6.2.5	Two-wire control, method 2 .....	187
6.2.6	Two-wire control, method 3 .....	188
6.2.7	Three-wire control, method 1 .....	189
6.2.8	Three-wire control, method 2 .....	190
6.2.9	Running the motor in jog mode (JOG function) .....	191
6.2.10	Control via PROFIBUS or PROFINET with the PROFIdrive profile .....	193
6.2.10.1	Control and status word 1 .....	195
6.2.10.2	Control and status word 3 .....	198
6.2.10.3	NAMUR message word .....	200
6.2.10.4	Data structure of the parameter channel .....	200
6.2.10.5	Examples of the parameter channel .....	204
6.2.10.6	Extend telegrams and change signal interconnection .....	206
6.2.10.7	Configuring the IP interface .....	208
6.2.10.8	Slave-to-slave communication .....	209
6.2.10.9	Acyclically reading and writing inverter parameters .....	209
6.2.11	Control via additional fieldbuses .....	210
6.2.11.1	Modbus RTU .....	210

6.2.11.2	USS .....	213
6.2.11.3	Ethernet/IP .....	216
6.2.12	Switching over the inverter control (command data set).....	217
6.3	Setpoints .....	219
6.3.1	Overview .....	219
6.3.2	Analog input as setpoint source.....	220
6.3.3	Specifying the setpoint via the fieldbus.....	221
6.3.4	Motorized potentiometer as setpoint source.....	222
6.3.5	Fixed speed as setpoint source .....	224
6.4	Setpoint calculation .....	227
6.4.1	Overview of setpoint processing .....	227
6.4.2	Invert setpoint.....	228
6.4.3	Inhibit direction of rotation.....	229
6.4.4	Skip frequency bands and minimum speed .....	230
6.4.5	Speed limitation.....	231
6.4.6	Ramp-function generator .....	232
6.5	Motor control .....	237
6.5.1	V/f control .....	237
6.5.1.1	Characteristics of U/f control.....	239
6.5.1.2	Optimizing motor starting .....	242
6.5.2	Vector control with speed controller.....	246
6.5.2.1	Overview .....	246
6.5.2.2	Optimizing the closed-loop speed controller .....	248
6.5.2.3	Advanced settings.....	250
6.5.2.4	Friction characteristic .....	252
6.5.2.5	Moment of inertia estimator .....	254
6.5.2.6	Pole position identification .....	259
6.5.3	Torque control.....	260
6.6	Protection functions .....	262
6.6.1	Inverter temperature monitoring.....	262
6.6.2	Motor temperature monitoring using a temperature sensor .....	265
6.6.3	Protecting the motor by calculating the motor temperature.....	269
6.6.4	Overcurrent protection .....	273
6.6.5	Limiting the maximum DC link voltage.....	274
6.7	Application-specific functions.....	276
6.7.1	Unit changeover .....	276
6.7.1.1	Changing over the motor standard .....	278
6.7.1.2	Changing over the unit system .....	279
6.7.1.3	Changing over process variables for the technology controller.....	279
6.7.1.4	Switching units with STARTER.....	280
6.7.2	Calculating the energy saving for fluid flow machines.....	281
6.7.3	Electrically braking the motor.....	283
6.7.3.1	DC braking .....	285
6.7.3.2	Compound braking.....	288
6.7.3.3	Dynamic braking .....	290
6.7.3.4	Braking with regenerative feedback to the line .....	292
6.7.4	Motor holding brake .....	293
6.7.5	Flying restart – switching on while the motor is running .....	298
6.7.6	Automatic restart.....	300
6.7.7	Kinetic buffering (Vdc min control).....	304

6.7.8	Line contactor control.....	306
6.7.9	PID technology controller.....	308
6.7.10	System protection .....	315
6.7.10.1	No-load monitoring, blocking protection, stall protection .....	316
6.7.10.2	Load monitoring .....	318
6.7.11	Free function blocks.....	326
6.7.11.1	Overview .....	326
6.7.11.2	Further information.....	326
6.8	Safe Torque Off (STO) safety function .....	327
6.8.1	Function description.....	327
6.8.2	Prerequisite for STO use .....	329
6.8.3	Commissioning STO .....	330
6.8.3.1	Commissioning tools.....	330
6.8.3.2	Safety functions password.....	330
6.8.3.3	Configuring a safety function .....	331
6.8.3.4	Configuring a safety function .....	332
6.8.3.5	Interconnecting the "STO active" signal .....	334
6.8.3.6	Setting the filter for safety-related inputs .....	336
6.8.3.7	Setting the forced checking procedure (test stop) .....	339
6.8.3.8	Activating the settings and checking the digital inputs .....	341
6.8.3.9	Approval - completing commissioning .....	345
6.9	Switchover between different settings .....	348
<b>7</b>	<b>Backing up data and series commissioning .....</b>	<b>351</b>
7.1	Backing up and transferring settings using a memory card.....	352
7.1.1	Saving setting on memory card .....	353
7.1.2	Transferring the setting from the memory card .....	357
7.1.3	Safely remove the memory card.....	361
7.2	Saving settings on a PC.....	363
7.3	Saving settings and transferring them using an operator panel .....	367
7.4	Other ways to back up settings.....	369
7.5	Write and know-how protection .....	370
7.5.1	Write protection.....	370
7.5.2	Know-how protection .....	372
7.5.2.1	Settings for know-how protection.....	373
7.5.2.2	Generating an exception list for know-how protection.....	376
<b>8</b>	<b>Corrective maintenance .....</b>	<b>377</b>
8.1	Replacing inverter components .....	377
8.1.1	Overview of replacing converter components .....	377
8.1.2	Replacing a Control Unit with enabled safety function .....	379
8.1.3	Replacing the Control Unit without the safety functions enabled .....	383
8.1.4	Replacing the Control Unit without data backup.....	386
8.1.5	Replacing a Control Unit with active know-how protection.....	387
8.1.6	Replacing a Power Module with enabled safety function .....	389
8.1.7	Replacing a Power Module without the safety function being enabled .....	390
8.2	Firmware upgrade and downgrade.....	391
8.2.1	Upgrading the firmware.....	392
8.2.2	Firmware downgrade .....	394

8.2.3	Correcting an unsuccessful firmware upgrade or downgrade .....	396
8.3	Reduced acceptance after component replacement and firmware change .....	397
8.4	If the converter no longer responds .....	398
<b>9</b>	<b>Alarms, faults and system messages .....</b>	<b>401</b>
9.1	Operating states indicated on LEDs .....	402
9.2	System runtime .....	404
9.3	Alarms .....	405
9.4	Faults .....	408
9.5	List of alarms and faults .....	413
9.6	Identification & maintenance data (I&M).....	421
<b>10</b>	<b>Technical data .....</b>	<b>423</b>
10.1	Technical data, CU240B-2 Control Unit.....	423
10.2	Technical data, CU240E-2 Control Unit.....	425
10.3	Technical data, Power Modules.....	428
10.3.1	Technical data, PM240-2 .....	429
10.3.1.1	High overload - low overload PM240-2.....	429
10.3.1.2	General data, PM240-2 - 200 V .....	430
10.3.1.3	Power-dependent data, PM240-2 - 200 V .....	432
10.3.1.4	General data, PM240-2 - 400 V .....	438
10.3.1.5	Power-dependent data, PM240-2 - 400 V .....	440
10.3.1.6	General data, PM240-2 - 600 V .....	447
10.3.1.7	Power-dependent data, PM240-2 - 600 V .....	448
10.3.2	Technical data, PM240 .....	451
10.3.2.1	General data, PM240 .....	452
10.3.2.2	Power-dependent data, PM240 .....	454
10.3.3	Technical data, PM230 IP20.....	460
10.3.3.1	General data, PM230 - IP20 .....	461
10.3.3.2	Power-dependent data, PM230, IP20.....	462
10.3.4	Technical data, PM250 .....	469
10.3.4.1	High Overload - Low Overload.....	469
10.3.4.2	General data, PM250 .....	469
10.3.4.3	Power-dependent data, PM250 .....	471
10.3.5	Technical data, PM260 .....	474
10.3.6	Data regarding the power loss in partial load operation .....	474
10.4	Restrictions for special ambient conditions.....	475
<b>A</b>	<b>Appendix .....</b>	<b>477</b>
A.1	New and extended functions.....	477
A.2	Parameter .....	485
A.3	Handling the BOP 2 operator panel.....	488
A.3.1	Changing settings using BOP-2.....	489
A.3.2	Changing indexed parameters.....	489
A.3.3	Directly entering the parameter number and value.....	490
A.3.4	A parameter cannot be changed.....	491



A.4	The device trace in STARTER.....	492
A.5	Interconnecting signals in the inverter .....	495
A.5.1	Fundamentals .....	495
A.5.2	Example .....	497
A.6	Connecting the safety-related input .....	499
A.7	Acceptance tests for the safety functions .....	501
A.7.1	Recommended acceptance test .....	501
A.7.2	Machine documentation.....	504
A.7.3	Documenting the settings for the basic functions, firmware V4.4 ... V4.7 SP6 .....	506
A.8	Manuals and technical support .....	507
A.8.1	Overview of the manuals .....	507
A.8.2	Configuring support.....	509
A.8.3	Product Support .....	510
A.9	Mistakes and improvements .....	510
<b>Index</b> .....		<b>511</b>



## Fundamental safety instructions

### 1.1 General safety instructions



	<p><b>! DANGER</b></p> <p><b>Danger to life due to live parts and other energy sources</b></p> <p>Death or serious injury can result when live parts are touched.</p> <ul style="list-style-type: none"> <li>• Only work on electrical devices when you are qualified for this job.</li> <li>• Always observe the country-specific safety rules.</li> </ul> <p>Generally, six steps apply when establishing safety:</p> <ol style="list-style-type: none"> <li>1. Prepare for shutdown and notify all those who will be affected by the procedure.</li> <li>2. Disconnect the machine from the supply.             <ul style="list-style-type: none"> <li>– Switch off the machine.</li> <li>– Wait until the discharge time specified on the warning labels has elapsed.</li> <li>– Check that it really is in a no-voltage condition, from phase conductor to phase conductor and phase conductor to protective conductor.</li> <li>– Check whether the existing auxiliary supply circuits are de-energized.</li> <li>– Ensure that the motors cannot move.</li> </ul> </li> <li>3. Identify all other dangerous energy sources, e.g. compressed air, hydraulic systems, or water.</li> <li>4. Isolate or neutralize all hazardous energy sources by closing switches, grounding or short-circuiting or closing valves, for example.</li> <li>5. Secure the energy sources against switching on again.</li> <li>6. Ensure that the correct machine is completely interlocked.</li> </ol> <p>After you have completed the work, restore the operational readiness in the inverse sequence.</p>
--	---



	<p><b>! WARNING</b></p> <p><b>Danger to life through a hazardous voltage when connecting an unsuitable power supply</b></p> <p>Touching live components can result in death or severe injury.</p> <ul style="list-style-type: none"> <li>• Only use power supplies that provide SELV (Safety Extra Low Voltage) or PELV- (Protective Extra Low Voltage) output voltages for all connections and terminals of the electronics modules.</li> </ul>
--	--



**! WARNING**

**Danger to life when live parts are touched on damaged devices**

Improper handling of devices can cause damage.

For damaged devices, hazardous voltages can be present at the enclosure or at exposed components; if touched, this can result in death or severe injury.

- Ensure compliance with the limit values specified in the technical data during transport, storage and operation.
- Do not use any damaged devices.



**! WARNING**

**Danger to life through electric shock due to unconnected cable shields**

Hazardous touch voltages can occur through capacitive cross-coupling due to unconnected cable shields.

- As a minimum, connect cable shields and the conductors of power cables that are not used (e.g. brake cores) at one end at the grounded housing potential.



**! WARNING**

**Danger to life due to electric shock when not grounded**

For missing or incorrectly implemented protective conductor connection for devices with protection class I, high voltages can be present at open, exposed parts, which when touched, can result in death or severe injury.

- Ground the device in compliance with the applicable regulations.



**! WARNING**

**Danger to life due to electric shock when opening plug connections in operation**

When opening plug connections in operation, arcs can result in severe injury or death.

- Only open plug connections when the equipment is in a no-voltage state, unless it has been explicitly stated that they can be opened in operation.

**! WARNING**

**Danger to life due to fire spreading if housing is inadequate**

Fire and smoke development can cause severe personal injury or material damage.

- Install devices without a protective housing in a metal control cabinet (or protect the device by another equivalent measure) in such a way that contact with fire is prevented.
- Ensure that smoke can only escape via controlled and monitored paths.

 **WARNING****Danger to life through unexpected movement of machines when using mobile wireless devices or mobile phones**

Using mobile wireless devices or mobile phones with a transmit power > 1 W closer than approx. 2 m to the components may cause the devices to malfunction, influence the functional safety of machines therefore putting people at risk or causing material damage.

- Switch the wireless devices or mobile phones off in the immediate vicinity of the components.

 **WARNING****Danger to life due to the motor catching fire in the event of insulation overload**

There is higher stress on the motor insulation through a ground fault in an IT system. If the insulation fails, it is possible that death or severe injury can occur as a result of smoke and fire.

- Use a monitoring device that signals an insulation fault.
- Correct the fault as quickly as possible so the motor insulation is not overloaded.

 **WARNING****Danger to life due to fire if overheating occurs because of insufficient ventilation clearances**

Inadequate ventilation clearances can cause overheating of components with subsequent fire and smoke. This can cause severe injury or even death. This can also result in increased downtime and reduced service lives for devices/systems.

- Ensure compliance with the specified minimum clearance as ventilation clearance for the respective component.

 **WARNING****Danger of an accident occurring due to missing or illegible warning labels**

Missing or illegible warning labels can result in accidents involving death or serious injury.

- Check that the warning labels are complete based on the documentation.
- Attach any missing warning labels to the components, in the national language if necessary.
- Replace illegible warning labels.

**NOTICE**

**Device damage caused by incorrect voltage/insulation tests**

Incorrect voltage/insulation tests can damage the device.

- Before carrying out a voltage/insulation check of the system/machine, disconnect the devices as all converters and motors have been subject to a high voltage test by the manufacturer, and therefore it is not necessary to perform an additional test within the system/machine.



**WARNING**

**Danger to life when safety functions are inactive**

Safety functions that are inactive or that have not been adjusted accordingly can cause operational faults on machines that could lead to serious injury or death.

- Observe the information in the appropriate product documentation before commissioning.
- Carry out a safety inspection for functions relevant to safety on the entire system, including all safety-related components.
- Ensure that the safety functions used in your drives and automation tasks are adjusted and activated through appropriate parameterizing.
- Perform a function test.
- Only put your plant into live operation once you have guaranteed that the functions relevant to safety are running correctly.

**Note**

**Important safety notices for Safety Integrated functions**

If you want to use Safety Integrated functions, you must observe the safety notices in the Safety Integrated manuals.



**WARNING**

**Danger to life or malfunctions of the machine as a result of incorrect or changed parameterization**

As a result of incorrect or changed parameterization, machines can malfunction, which in turn can lead to injuries or death.

- Protect the parameterization (parameter assignments) against unauthorized access.
- Respond to possible malfunctions by applying suitable measures (e.g. EMERGENCY STOP or EMERGENCY OFF).

## 1.2 Safety instructions for electromagnetic fields (EMF)



### ! WARNING

#### Danger to life from electromagnetic fields

Electromagnetic fields (EMF) are generated by the operation of electrical power equipment such as transformers, converters or motors.

People with pacemakers or implants are at a special risk in the immediate vicinity of these devices/systems.

- Ensure that the persons involved are the necessary distance away (minimum 2 m).

## 1.3 Handling electrostatic sensitive devices (ESD)

Electrostatic sensitive devices (ESD) are individual components, integrated circuits, modules or devices that may be damaged by either electric fields or electrostatic discharge.



### NOTICE

#### Damage through electric fields or electrostatic discharge

Electric fields or electrostatic discharge can cause malfunctions through damaged individual components, integrated circuits, modules or devices.

- Only pack, store, transport and send electronic components, modules or devices in their original packaging or in other suitable materials, e.g. conductive foam rubber or aluminum foil.
- Only touch components, modules and devices when you are grounded by one of the following methods:
  - Wearing an ESD wrist strap
  - Wearing ESD shoes or ESD grounding straps in ESD areas with conductive flooring
- Only place electronic components, modules or devices on conductive surfaces (table with ESD surface, conductive ESD foam, ESD packaging, ESD transport container).

## 1.4 Industrial security

### Note

#### Industrial security

Siemens provides products and solutions with industrial security functions that support the secure operation of plants, solutions, machines, equipment and/or networks. They are important components in a holistic industrial security concept. With this in mind, Siemens' products and solutions undergo continuous development. Siemens recommends strongly that you regularly check for product updates.

For the secure operation of Siemens products and solutions, it is necessary to take suitable preventive action (e.g. cell protection concept) and integrate each component into a holistic, state-of-the-art industrial security concept. Third-party products that may be in use should also be considered. For more information about industrial security, visit this address (<http://www.siemens.com/industrialsecurity>).

To stay informed about product updates as they occur, sign up for a product-specific newsletter. For more information, visit this address (<http://support.automation.siemens.com>).

### WARNING

#### **Danger as a result of unsafe operating states resulting from software manipulation**

Software manipulation (e.g. by viruses, Trojan horses, malware, worms) can cause unsafe operating states to develop in your installation which can result in death, severe injuries and/or material damage.

- Keep the software up to date.  
You will find relevant information and newsletters at this address (<http://support.automation.siemens.com>).
- Incorporate the automation and drive components into a holistic, state-of-the-art industrial security concept for the installation or machine.  
You will find further information at this address (<http://www.siemens.com/industrialsecurity>).
- Make sure that you include all installed products into the holistic industrial security concept.



## 1.5 Residual risks of power drive systems

The control and drive components of a drive system are approved for industrial and commercial use in industrial line supplies. Their use in public line supplies requires a different configuration and/or additional measures.

These components may only be operated in closed housings or in higher-level control cabinets with protective covers that are closed, and when all of the protective devices are used.

These components may only be handled by qualified and trained technical personnel who are knowledgeable and observe all of the safety instructions on the components and in the associated technical user documentation.

When assessing the machine's risk in accordance with the respective local regulations (e.g., EC Machinery Directive), the machine manufacturer must take into account the following residual risks emanating from the control and drive components of a drive system:

1. Unintentional movements of driven machine components during commissioning, operation, maintenance, and repairs caused by, for example,
  - Hardware and/or software errors in the sensors, control system, actuators, and cables and connections
  - Response times of the control system and of the drive
  - Operation and/or environmental conditions outside the specification
  - Condensation/conductive contamination
  - Parameterization, programming, cabling, and installation errors
  - Use of wireless devices/mobile phones in the immediate vicinity of the control system
  - External influences/damage
2. In the event of a fault, exceptionally high temperatures, including an open fire, as well as emissions of light, noise, particles, gases, etc. can occur inside and outside the inverter, e.g.:
  - Component failure
  - Software errors
  - Operation and/or environmental conditions outside the specification
  - External influences/damage

Inverters of the Open Type/IP20 degree of protection must be installed in a metal control cabinet (or protected by another equivalent measure) such that contact with fire inside and outside the inverter is not possible.

3. Hazardous shock voltages caused by, for example,
  - Component failure
  - Influence during electrostatic charging
  - Induction of voltages in moving motors
  - Operation and/or environmental conditions outside the specification
  - Condensation/conductive contamination
  - External influences/damage
4. Electrical, magnetic and electromagnetic fields generated in operation that can pose a risk to people with a pacemaker, implants or metal replacement joints, etc., if they are too close
5. Release of environmental pollutants or emissions as a result of improper operation of the system and/or failure to dispose of components safely and correctly

---

**Note**

The components must be protected against conductive contamination (e.g. by installing them in a control cabinet with degree of protection IP54 according to IEC 60529 or NEMA 12).

Assuming that conductive contamination at the installation site can definitely be excluded, a lower degree of cabinet protection may be permitted.

---

For more information about residual risks of the components in a drive system, see the relevant sections in the technical user documentation.

# Introduction

## 2.1 About the Manual

### Who requires the operating instructions and what for?

These operating instructions primarily address fitters, commissioning engineers and machine operators. The operating instructions describe the devices and device components and enable the target groups being addressed to install, connect-up, set, and commission the converters safely and in the correct manner.

### What is described in the operating instructions?

These operating instructions provide a summary of all of the information required to operate the converter under normal, safe conditions.

The information provided in the operating instructions has been compiled in such a way that it is sufficient for all standard applications and enables drives to be commissioned as efficiently as possible. Where it appears useful, additional information for entry level personnel has been added.

The operating instructions also contain information about special applications. Since it is assumed that readers already have a sound technical knowledge of how to configure and parameterize these applications, the relevant information is summarized accordingly. This relates, e.g. to operation with fieldbus systems and safety-related applications.

### What is the meaning of the symbols in the manual?

 Reference to further information in the manual

 1 An operating instruction starts here.  
2

 This concludes the operating instruction.







 Download from the Internet



 DVD that can be ordered

 Symbols for inverter functions.



## 2.2 Guide through the manual

Section	In this section you will find answers to the following questions:
 Description (Page 27)	<ul style="list-style-type: none"> <li>• How is the inverter marked?</li> <li>• Which components make up the inverter?</li> <li>• Which optional components are available for the inverter?</li> <li>• What is the purpose of the optional components?</li> <li>• Which motors can be fed from the inverter?</li> <li>• Which commissioning tools are there?</li> </ul>
 Installing (Page 53)	<ul style="list-style-type: none"> <li>• Which sequence is recommended when installing the inverter?</li> <li>• What does EMC-compliant installation actually mean?</li> <li>• Which options are available to install optional components below the inverter?</li> <li>• What are the inverter dimensions?</li> <li>• Which mounting and installation materials are required when installing the inverter?</li> <li>• To which line supplies can the inverter be connected?</li> <li>• How is the inverter connected to the line supply?</li> <li>• How is the braking resistor connected to the inverter?</li> <li>• Which terminals and fieldbus interfaces does the inverter have?</li> <li>• What are the interface functions?</li> </ul>
 Commissioning (Page 127)	<ul style="list-style-type: none"> <li>• Which motor data is required for commissioning</li> <li>• How is the inverter set in the factory?</li> <li>• What is the commissioning procedure?</li> <li>• How do you restore the inverter factory settings?</li> </ul>
 Advanced commissioning (Page 169)	<ul style="list-style-type: none"> <li>• Which functions are included in the inverter firmware?</li> <li>• How do the functions interoperate with one another?</li> <li>• How are the functions set?</li> </ul>
 Backing up data and series commissioning (Page 351)	<ul style="list-style-type: none"> <li>• Why is it necessary to back up the inverter settings?</li> <li>• Which options are available to back up the settings?</li> <li>• How does the data backup function?</li> <li>• How do you prevent the inverter settings from being changed?</li> <li>• How do you prevent the inverter settings from being read out?</li> </ul>
 Corrective maintenance (Page 377)	<ul style="list-style-type: none"> <li>• How are inverter components replaced?</li> <li>• How do you change the firmware version of the inverter?</li> </ul>
 Alarms, faults and system messages (Page 401)	<ul style="list-style-type: none"> <li>• What is the meaning of the LEDs provided on the inverter?</li> <li>• How does the system runtime respond?</li> <li>• How does the inverter save alarms and faults?</li> <li>• What do the inverter alarms and faults mean?</li> <li>• How are inverter faults resolved?</li> <li>• Which I&amp;M data is saved in the inverter?</li> </ul>

Section	In this section you will find answers to the following questions:
 Technical data (Page 423)	<ul style="list-style-type: none"> <li>• What is the inverter technical data?</li> <li>• What do "High Overload" and "Low Overload" mean?</li> </ul>
 Appendix (Page 477)	<ul style="list-style-type: none"> <li>• What are the new functions of the current firmware?</li> <li>• What are the most important inverter parameters?</li> <li>• How is the inverter operated using the BOP-2 Operator Panel?</li> <li>• How does the device trace function in STARTER?</li> <li>• How can signal interconnections be changed in the inverter firmware?</li> <li>• What does "BiCo technology" mean?</li> <li>• Where can you find additional manuals and information about the inverter?</li> </ul>



## Description

### Use for the intended purpose

The inverter described in this manual is a device to control a three-phase motor. The inverter is designed for installation in electrical installations or machines.

It has been approved for industrial and commercial use on industrial networks. Additional measures have to be taken when connected to public grids.

The technical specifications and information about connection conditions are indicated on the rating plate and in the operating instructions.

## 3.1 Identifying the converter

### Main components of the inverter

Each SINAMICS G120 inverter comprises a Control Unit and a Power Module.

- The Control Unit controls and monitors the connected motor.
- The Power Module provides the connections for line supply and motor.

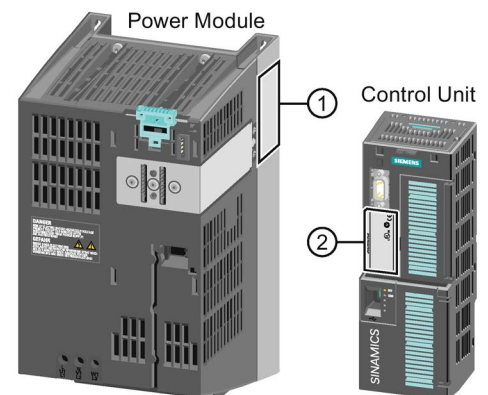

The following data is provided on the Power Module type plate (①):







- Designation: e.g. Power Module 240
- Technical data: Voltage and current
- Article number: e.g. 6SL3224-0BE13-7UA0
- Version: e.g. A02

The following data can be found on the Control Unit type plate (②):

- Designation: e.g. Control Unit CU240E-2 DP-F
- Article number: e.g. 6SL3244-0BB13-1PA0
- Version: e.g. A02 (hardware)

### **Additional inverter components**

The following components are available so that you can adapt the inverter to different applications and ambient conditions:

-  Line filter (Page 36)
-  Line reactor (Page 38)
-  Output reactor (Page 40)
-  Sine-wave filter (Page 43)
-  Braking resistor (Page 45)
-  Brake relay to control a motor holding brake (Page 48)



## 3.2 Overview of Control Units

Table 3- 1 Control Units CU240B-2 ...



	The CU240B-2 Control Units differ with regard to the type of fieldbus.		
	Designation	CU240B-2	CU240B-2 DP
	Article number	6SL3244-0BB00-1BA1	6SL3244-0BB00-1PA1
	Fieldbus	USS, Modbus RTU	PROFIBUS DP

Table 3- 2 Control Units CU240E-2 ...

	The CU240E-2 Control Units have, in comparison to the CU240B-2, an extended terminal strip with integrated safety functions. The CU240E-2 Control Units differ with regard to the type of fieldbus and the scope of the integrated safety functions.					
	Designation	CU240E-2	CU240E-2 F	CU240E-2 DP	CU240E-2 DP-F	CU240E-2 PN
Article number	6SL3244-0BB12-1BA1	6SL3244-0BB13-1BA1	6SL3244-0BB12-1PA1	6SL3244-0BB13-1PA1	6SL3244-0BB12-1FA0	6SL3244-0BB13-1FA0
Fieldbus	USS, Modbus RTU	USS, Modbus RTU	PROFIBUS DP	PROFIBUS DP	PROFINET IO, EtherNet/IP	PROFINET IO, EtherNet/IP
Integrated safety functions	Basic functions	Extended functions	Basic functions	Extended functions	Basic functions	Extended functions

### Memory cards

Table 3- 3 Memory cards to back up inverter settings

Scope of delivery	Article number
Memory card without firmware	6SL3054-4AG00-2AA0
Memory card with firmware V4.5	6SL3054-7EF00-2BA0
Memory card with firmware V4.6	6SL3054-7EG00-2BA0
Memory card with firmware V4.7	6SL3054-7EH00-2BA0
Memory card with firmware V4.7 SP3	6SL3054-7TB00-2BA0
Memory card with firmware V4.7 SP6	6SL3054-7TD00-2BA0

3.2 Overview of Control Units

**Shield connection kit for the Control Unit**

The shield connection kit is an optional component. The shield connection kit comprises the following components:

- Shield plate
- Elements for optimum shield support and strain relief of the signal and communication cables

Table 3- 4 Article Nos.

Shield connection kit 2 for CU240B-2 and CU240E-2 Control Units with all fieldbus interfaces with the exception of PROFINET.	6SL3264-1EA00-0HA0
Shield connection kit 3 for the CU230P-2 and CU240E-2 Control Units with PROFINET interface.	6SL3264-1EA00-0HB0

**Distance connector for operation with a PM230 Power Module IP55**

When operating the Control Unit with a PM230 IP55 Power Module, a distance connector is required between the Control Unit and operator panel (BOP-2 or IOP).



Image 3-1 Distance connector for the connection between a Control Unit and Operator panel

Ordered and supplied from KnorrTec, Article No. 10055500

### 3.3 Power Module

Important data on the Power Modules is provided in this section. Further information is contained in the Hardware Installation Manual of the Power Module.

 Overview of the manuals (Page 507)

All power data refers to rated values or to power for operation with low overload (LO).

#### Which Power Module can I use with the Control Unit?

Table 3- 5 Permitted combinations of Control Unit and Power Module

Control Unit	Power Module						
	PM340 1AC	PM230		PM240	PM240-2	PM250	PM260
		IP20 and push-through system	IP55				
CU240B-2...	---	✓	---	✓	✓	✓	✓
CU240E-2...	✓	✓	✓	✓	✓	✓	✓

#### 3.3.1 Power Modules in degree of protection IP20 and with push-through system



Image 3-2 Examples of Power Modules with degree of protection IP20

3.3 Power Module



Image 3-3 Examples of Power Modules with Push Through technology FSA ... FSC

**PM230, 3 AC 400 V - pump and fan applications**

The PM230 Power Module is available without a filter or with integrated class A line filter.

- Article number range:
- IP20: 6SL3210-1NE...
  - Push Through: 6SL3211-1NE...

Frame size	FSA	FSB	FSC	FSD	FSE	FSF	
Power range (kW), IP20	0.37 ... 3	4 ... 7.5	11 ... 18.5	22 ... 37	45 ... 55	75 ... 90	
Power range (kW), PT	3	7.5	18.5	---	---	---	

**PM240-2 - for standard applications**

The PM240-2 Power Module is available without a filter or with an integrated class A line filter. The PM240-2 permits dynamic braking via an external braking resistor.

**1-phase/3-phase 200 VAC**

- Article number range:
- IP20: 6SL3210-1PB..., 6SL3210-1PC...
  - Push Through: 6SL3211-1PB...

Frame size	FSA	FSB	FSC	FSD	FSE	FSF	
Power range (kW), IP20	0.55 ... 0.75	1.1 ... 2.2	3.0 ... 4.0	11 ... 18.5	22 ... 30	37 ... 55	
Power range (kW), PT	0.75	2.2	4.0	---	---	---	

**3-phase 400 VAC**

- Article number range:
- IP20: 6SL3210-1PE...
  - Push Through: 6SL3211-1PE...

Frame size	FSA	FSB	FSC	FSD	FSE	FSF	
Power range (kW), IP20	0.55 ... 3.0	4.0 ... 7.5	11 ... 15	18.5 ... 37	45 ... 55	75 ... 132	
Power range (kW), PT	3.0	7.5	15	---	---	---	

**3-phase 600 VAC**

- Article number range:
- IP20: 6SL3210-1PH...
  - Push Through: 6SL3211-1PH...

Frame size	FSA	FSB	FSC	FSD	FSE	FSE	
Power range (kW), IP20	---	---	---	11 ... 37	45 ... 55	75 ... 132	
Power range (kW), PT	---	---	---	---	---	---	

**PM240, 3 AC 400 V - for standard applications**

The PM240 Power Module is available without a filter or with an integrated class A line filter with degree of protection IP20. The PM240 allows dynamic braking via an external braking resistor.

Article number range: 6SL3224-0BE... and 6SL3224-0XE...

Frame size	FSA	FSB	FSC	FSD	FSE	FSF	GX
Power range (kW)	0.37 ... 1.5	2.2 ... 4	7.5 ... 15	18.5 ... 30	37 ... 45	55 ... 132	160 ... 250

**PM340, 1 AC 200 V - Standard applications**

The PM340 Power Module is available without a filter or with an integrated class A line filter with degree of protection IP20. The PM340 allows dynamic braking via an external braking resistor.

Range of article numbers: 6SL3210-1SB1...

Frame size	FSA	FSB	FSC	FSD	FSE	FSF	FSGX
Power range (kW)	0.12 ... 0.75	--	--	--	--	--	---

**PM250, 3 AC 400 V - Applications with energy recovery**

The PM250 Power Module is available without a filter or with an integrated class A line filter with degree of protection IP20. The PM250 permits dynamic braking with energy recovery into the line supply.

Article number range, IP20: 6SL3225-0BE ...

Frame size	FSC	FSD	FSE	FSF			
Power range (kW)	7.5 ... 15	18.5 ... 30	37 ... 45	55 ... 90			

**PM260, 3 AC 690 V - Applications with energy recovery**

The PM260 Power Module is available without a filter or with an integrated class A line filter with degree of protection IP20. A sine-wave filter is fitted to the motor. The PM260 permits dynamic braking with energy recovery into the line supply.

Article number range, IP20: 6SL3225-0BH...

Frame size	FSD	FSF					
Power range (kW)	11 ... 18.5	30 ... 55					

### 3.3.2 Power Module in IP55 degree of protection / UL Type 12

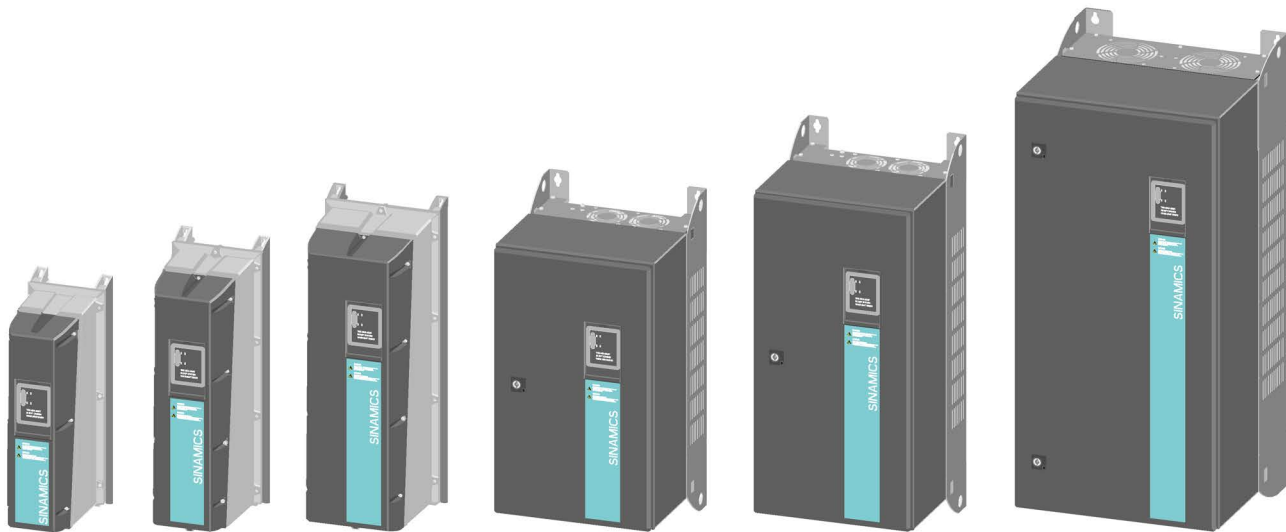

#### PM230, 3 AC 400 V, degree of protection IP55 / UL Type 12

Frame size		FSA	FSB	FSC	FSD	FSE	FSF
Power range (kW)	Filter Class A	0.37 ... 3	4 ... 7.5	11 ... 18.5	22 ... 30	37 ... 45	55 ... 90
	Filter Class B	0.37 ... 3	4 ... 7.5	11 ... 15	18.5 ... 30	37 ... 45	55 ... 90

The Power Module PM230 IP55/UL Type 12 is suitable for installation close to the motor.

Article number range: 6SL3223-0DE...

## 3.4 Components for the Power Modules

### 3.4.1 Accessories for installation and shielding

#### Shield connection kit

Establish the shield and strain relief for the power connections using the shield connection kit.

The shield connection kit comprises a shield plate and serrated strips with screws.

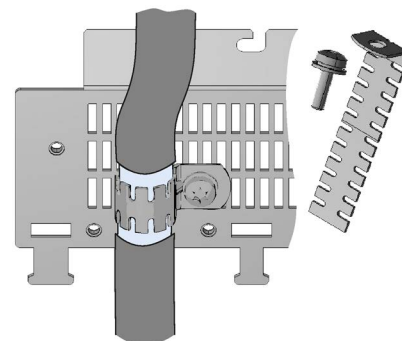

Table 3- 6 Article numbers for the shield connection kit

Frame size	Power Modules PM240, PM250	PM260	PM230, PM240-2
FSA	6SL3262-1AA00-0BA0	-	The shield connection kit is included in the scope of delivery
FSB	6SL3262-1AB00-0DA0	-	
FSC	6SL3262-1AC00-0DA0	-	
FSD	6SL3262-1AD00-0DA0	6SL3262-1FD00-0CA0	
FSE	6SL3262-1AD00-0DA0	-	
FSF	6SL3262-1AF00-0DA0	6SL3262-1FF00-0CA0	

#### Adapter for mounting on DIN mounting rails for PM240, PM250 and PM260

You can use the adapter for rail mounting to mount the Power Module onto two mounting rails with a center-to-center distance of 100 mm.

Frame size	Article numbers for adapters for mounting on DIN mounting rails
FSA	6SL3262-1BA00-0BA0
FSB	6SL3262-1BB00-0BA0

### 3.4.2 Line filter

With a line filter, the inverter can achieve a higher radio interference class. An external filter is not required for inverters with integrated line filter. Adjacent examples of line filters. The line filter corresponds to Class A or B according to EN55011: 2009.



<b>NOTICE</b>
<b>The line filter is damaged when operated on inadmissible line supplies</b>
The line filter is only suitable for operation on TN or TT line systems with a grounded neutral point. The line filter is damaged if operated on all other line supplies.
<ul style="list-style-type: none"> <li>For inverters equipped with line filter, only connect to TN or TT line systems with a grounded neutral point.</li> </ul>

#### External line filters for PM240

Power Module		Power	Line filter, class A
FSA	6SL3224-0BE13-7UA0, 6SL3224-0BE15-5UA0, 6SL3224-0BE17-5UA0, 6SL3224-0BE21-1UA0, 6SL3224-0BE21-5UA0	0.37 kW ... 1.5 kW	6SE6400-2FA00-6AD0
FSF	6SL3224-0BE38-8UA0, 6SL3224-0BE41-1UA0	110 kW ... 132 kW	6SL3203-0BE32-5AA0
GX	6SL3224-0XE41-3UA0, 6SL3224-0XE41-6UA0	160 kW ... 200 kW	6SL3000-0BE34-4AA0
	6SL3224-0XE42-0UA0	250 kW	6SL3000-0BE36-0AA0

Power Module		Power	Line filter, class B
FSA	6SL3224-0BE13-7UA0, 6SL3224-0BE15-5UA0, 6SL3224-0BE17-5UA0, 6SL3224-0BE21-1UA0, 6SL3224-0BE21-5UA0	0.37 kW ... 1.5 kW	6SE6400-2FB00-6AD0
FSB	6SL3224-0BE22-2AA0, 6SL3224-0BE23-0AA0, 6SL3224-0BE24-0AA0	2.2 kW ... 4.0 kW	6SL3203-0BE21-6SA0
FSC	6SL3224-0BE25-5UA0, 6SL3224-0BE27-5UA0, 6SL3224-0BE31-1UA0	7.5 kW ... 15.0 kW	6SL3203-0BD23-8SA0



**External line filters for PM250**

Power Module		Power	Line filter, class B
FSC	6SL3225-0BE25-5AA0, 6SL3225-0BE27-5AA0, 6SL3225-0BE31-1AA0	7.5 kW ... 15.0 kW	6SL3203-0BD23-8SA0

### 3.4.3 Line reactor

The line reactor supports the overvoltage protection, smoothes the harmonics in the line supply and bridges commutation dips. For the Power Modules subsequently listed, a line reactor is suitable in order to dampen the specified effects.



for PM240

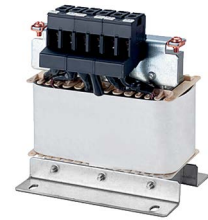

for PM240-2

<b>NOTICE</b>
<b>Damage to inverter as a result of a missing line reactor</b>
Depending on the Power Module and line supply, if a line reactor is not used, this can result in damage to the inverter and other components in the electrical plant or system.
<ul style="list-style-type: none"> <li>• Install a line reactor if the relative short-circuit voltage of the line supply is below 1%</li> </ul>

#### Line reactors for PM240

Power Module	Power	Line reactor	
FSA	6SL3224-0BE13-7UA0, 6SL3224-0BE15-5UA0	0.37 kW ... 0.55 kW	6SE6400-3CC00-2AD3
	6SL3224-0BE17-5UA0, 6SL3224-0BE21-1UA0	0.75 kW ... 1.1 kW	6SE6400-3CC00-4AD3
	6SL3224-0BE21-5UA0	1.5 kW	6SE6400-3CC00-6AD3
FSB	6SL3224-0BE22-2□A0, 6SL3224-0BE23-0□A0	2.2 kW ... 3.0 kW	6SL3203-0CD21-0AA0
	6SL3224-0BE24-0□A0	4.0 kW	6SL3203-0CD21-4AA0
FSC	6SL3224-0BE25-5□A0, 6SL3224-0BE27-5□A0	7.5 kW ... 11.0 kW	6SL3203-0CD22-2AA0
	6SL3224-0BE31-1□A0	15.0 kW	6SL3203-0CD23-5AA0
FSD	6SL3224-0BE31-5□A0, 6SL3224-0BE31-8□A0	18.5 kW ... 22 kW	6SL3203-0CJ24-5AA0
	6SL3224-0BE32-2□A0	30 kW	6SL3203-0CD25-3AA0
FSE	6SL3224-0BE33-0□A0, 6SL3224-0BE33-7□A0	37 kW ... 45 kW	6SL3203-0CJ28-6AA0
FSF	6SL3224-0BE34-5□A0, 6SL3224-0BE35-5□A0	55 kW ... 75 kW	6SE6400-3CC11-2FD0
	6SL3224-0BE37-5□A0	90 kW	6SE6400-3CC11-7FD0
	6SL3224-0BE38-8UA0	110 kW	6SL3000-0CE32-3AA0
	6SL3224-0BE41-1UA0	132 kW	6SL3000-0CE32-8AA0
GX	6SL3224-0XE41-3UA0	160 kW	6SL3000-0CE33-3AA0
	6SL3224-0XE41-6UA0, 6SL3224-0XE42-0UA0	200 kW ... 250 kW	6SL3000-0CE35-1AA0

**Line reactors for PM240-2, 200 V**

Power Module		Power	Line reactor
FSA	6SL3210-1PB13-0□L0, 6SL3210-1PB13-8□L0	0.55 kW ... 0.75 kW	6SL3203-0CE13-2AA0
FSB	6SL3210-1PB15-5□L0, 6SL3210-1PB17-4□L0, 6SL321□-1PB21-0□L0	1.1 kW ... 2.2 kW	6SL3203-0CE21-0AA0
FSC	6SL3210-1PB21-4□L0, 6SL321□-1PB21-8□L0	3 kW ... 4 kW	6SL3203-0CE21-8AA0
	6SL321□-1PC22-2□L0, 6SL3210-1PC22-8□L0	5.5 kW ... 7.5 kW	6SL3203-0CE23-8AA0

FSD ... FSF: A line reactor is not required.

**Line reactors for PM240-2, 400 V**

Power Module		Power	Line reactor
FSA	6SL3210-1PE11-8□L1, 6SL3210-1PE12-3□L1, 6SL3210-1PE13-2□L1	0.55 kW ... 1.1 kW	6SL3203-0CE13-2AA0
FSB	6SL3210-1PE14-3□L1, 6SL321□-1PE16-1□L1, 6SL321□-1PE18-0□L1	1.5 kW ... 3 kW	6SL3203-0CE21-0AA0
FSC	6SL3210-1PE21-1□L0, 6SL3210-1PE21-4□L0, 6SL321□-1PE21-8□L0	4 kW ... 7.5 kW	6SL3203-0CE21-8AA0
	6SL3210-1PE22-7□L0, 6SL321□-1PE23-3□L0	11 kW ... 15 kW	6SL3203-0CE23-8AA0

FSD ... FSF: A line reactor is not required.

**Line reactors for PM240-2 Power Module, 600 V**

A line reactor is not required.

**Line reactors for PM340 1AC**

Article number	Power	Line reactor
FSA	6SL3210-1SB11-0□A0, 6SL3210-1SB12-3□A0	0.12 kW ... 0.37 kW
	6SL3210-1SB14-0□A0	0.75 kW
		6SE6400-3CC00-4AB3
		6SE6400-3CC01-0AB3

### 3.4.4 Output reactor

Output reactors reduce the voltage stress on the motor windings and the load placed on the inverter as a result of capacitive recharging currents in the cables. An output reactor is required for shielded motor cables longer than 50 m or unshielded motor cables longer than 100 m.



<b>NOTICE</b>
<b>The output reactor is damaged if the inverter pulse frequency is too high</b>
The output reactors are designed for pulse frequencies of 4 kHz. The output reactor can overheat if the inverter is operated with pulse frequencies > 4 KHz. Excessively high temperatures damage the output reactor.
<ul style="list-style-type: none"> <li>Operate the inverter with an output reactor with a maximum pulse frequency of 4 kHz.</li> </ul>

### Output reactors for PM240 Power Module

Power Module	Power	Output reactor
FSA 6SL3224-0BE13-7UA0, 6SL3224-0BE15-5UA0, 6SL3224-0BE17-5UA0, 6SL3224-0BE21-1UA0, 6SL3224-0BE21-5UA0	0.37 kW ... 1.5 kW	6SE6400-3TC00-4AD2
FSB 6SL3224-0BE22-2□A0, 6SL3224-0BE23-0□A0, 6SL3224-0BE24-0□A0	2.2 kW ... 4.0 kW	6SL3202-0AE21-0CA0
FSC 6SL3224-0BE25-5□A0, 6SL3224-0BE27-5□A0, 6SL3224-0BE31-1□A0	7.5 kW ... 15.0 kW	6SL3202-0AJ23-2CA0
FSD 6SL3224-0BE31-5□A0 6SL3224-0BE31-8□A0 6SL3224-0BE32-2□A0	18.5 kW	6SE6400-3TC05-4DD0
	22 kW	6SE6400-3TC03-8DD0
	30 kW	6SE6400-3TC05-4DD0
FSE 6SL3224-0BE33-0□A0 6SL3224-0BE33-7□A0	37 kW	6SE6400-3TC08-0ED0
	45 kW	6SE6400-3TC07-5ED0
FSF 6SL3224-0BE34-5□A0 6SL3224-0BE35-5□A0 6SL3224-0BE37-5□A0 6SL3224-0BE38-8UA0 6SL3224-0BE41-1UA0	55 kW	6SE6400-3TC14-5FD0
	75 kW	6SE6400-3TC15-4FD0
	90 kW	6SE6400-3TC14-5FD0
	110 kW	6SL3000-2BE32-1AA0
	132 kW	6SL3000-2BE32-6AA0

Power Module		Power	Output reactor
GX	6SL3224-0XE41-3UA0	160 kW	6SL3000-2BE33-2AA0
	6SL3224-0XE41-6UA0	200 kW	6SL3000-2BE33-8AA0
	6SL3224-0XE42-0UA0	250 kW	6SL3000-2BE35-0AA0

### Output reactors for PM250 Power Module

Power Module		Power	Output reactor	
FSC	6SL3225-0BE25-5□A0, 6SL3225-0BE27-5□A0, 6SL3225-0BE31-1□A0	7.5 kW ... 15.0 kW	6SL3202-0AJ23-2CA0	
	FSD	6SL3225-0BE31-5□A0	18,5 kW	6SE6400-3TC05-4DD0
		6SL3225-0BE31-8□A0	22 kW	6SE6400-3TC03-8DD0
	6SL3225-0BE32-2□A0	30 kW	6SE6400-3TC05-4DD0	
FSE	6SL3225-0BE33-0□A0	37 kW	6SE6400-3TC08-0ED0	
	6SL3225-0BE33-7□A0	45 kW	6SE6400-3TC07-5ED0	
FSF	6SL3225-0BE34-5□A0	55 kW	6SE6400-3TC14-5FD0	
	6SL3225-0BE35-5□A0	75 kW	6SE6400-3TC15-4FD0	
	6SL3225-0BE37-5□A0	90 kW	6SE6400-3TC14-5FD0	

### Output reactors for PM230 Power Modules (IP20)

Power Module		Power	Output reactor	
FSA	6SL3210-1NE11-3□L0, 6SL3210-1NE11-7□L0, 6SL3210-1NE12-2□L0, 6SL3210-1NE13-1□L0, 6SL3210-1NE14-1□L0, 6SL3210-1NE15-8□L0	0.37 kW ... 2.2 kW	6SL3202-0AE16-1CA0	
	6SL3210-1NE17-7□L0	3.0 kW	6SL3202-0AE18-8CA0	
FSB	6SL3210-1NE21-0□L0, 6SL3210-1NE21-3□L0, 6SL3210-1NE21-8□L0	4.0 kW ... 7.5 kW	6SL3202-0AE21-8CA0	
	FSC	6SL3210-1NE22-6□L0, 6SL3210-1NE23-2□L0, 6SL3210-1NE23-8□L0	11.0 kW ... 18.5 kW	6SL3202-0AE23-8CA0
		FSD	6SL3210-1NE24-5□L0	22 kW
6SL3210-1NE26-0□L0	30 kW		6SE6400-3TC05-4DD0	
FSE	6SL3210-1NE27-5□L0	37 kW	6SE6400-3TC08-0ED0	
	6SL3210-1NE28-8□L0	45 kW	6SE6400-3TC07-5ED0	
FSF	6SL3210-1NE31-1□L0	55 kW	6SE6400-3TC14-5FD0	
	6SL3210-1NE31-5□L0	75 kW	6SE6400-3TC15-4FD0	

## Output reactors for PM230 push-through Power Modules

Power Module		Power	Output reactor
FSA	6SL3211-1NE17-7□L0	3.0 kW	6SL3202-0AE18-8CA0
FSB	6SL3211-1NE21-8□L0	7.5 kW	6SL3202-0AE21-8CA0
FSC	6SL3211-1NE23-8□L0	18.5 kW	6SL3202-0AE23-8CA0

## Output reactors for PM240-2 Power Module, 200 V

Power Module		Power	Output reactor
FSA	6SL3210-1PB13-0□L0, 6SL321□-1PB13-8□L0	0.55 kW ... 0.75 kW	6SL3202-0AE16-1CA0
FSB	6SL3210-1PB15-5□L0	1.1 kW	
	6SL3210-1PB17-4□L0	1.5 kW	6SL3202-0AE18-8CA0
FSB	6SL321□-1PB21-0□L0	2.2 kW	6SL3202-0AE21-8CA0
FSC	6SL3210-1PB21-4□L0, 6SL321□-1PB21-8□L0	3 kW ... 4 kW	6SL3202-0AE23-8CA0
	6SL321□-1PC22-2□L0, 6SL3210-1PC22-8□L0	5.5 kW ... 7.5 kW	

FSD ... FSF: An output reactor is not required.

## Output reactors for PM240-2 Power Module, 400 V

Power Module		Power	Output reactor
FSA	6SL3210-1PE11-8□L1, 6SL3210-1PE12-3□L1, 6SL3210-1PE13-2□L1, 6SL3210-1PE14-3□L1, 6SL3210-1PE16-1□L1	0.55 kW ... 2.2 kW	6SL3202-0AE16-1CA0
	6SL321□-1PE18-0UL1	3 kW	
FSB	6SL3210-1PE21-1□L0, 6SL3210-1PE21-4□L0, 6SL321□-1PE21-8□L0	4 kW ... 7.5 kW	6SL3202-0AE21-8CA0
FSC	6SL3210-1PE22-7□L0, 6SL321□-1PE23-3□L0	11 kW ... 15 kW	6SL3202-0AE23-8CA0

FSD ... FSF: An output reactor is not required.

## Output reactors for the PM240-2 Power Module, 600 V

An output reactor is not required.

### 3.4.5 Sine-wave filter

The sine-wave filter at the inverter output limits the voltage rate-of-rise and the peak voltages at the motor winding. The maximum permissible length of motor feeder cables is increased to 300 m.

The following applies when using a sine-wave filter:

- Operation is only permissible with pulse frequencies of 4 kHz up to 8 kHz.  
For Power Modules with a power rating starting at 110 kW and higher (as stamped on the type plates), only 4 kHz is permissible.
- The inverter power is reduced by 5%.
- The maximum output frequency of the inverter is 150 Hz at 380 V to 480 V.
- Operation and commissioning may only be performed with the motor connected, as the sine-wave filter is not no-load proof.
- An output reactor is superfluous.



for FSF

#### Sine-wave filter for PM240 Power Module

Power Module		Power	Sine-wave filter
FSA	6SL3224-0BE13-7UA0, 6SL3224-0BE15-5UA0, 6SL3224-0BE17-5UA0	0.37 kW ... 0.75 kW	6SL3202-0AE20-3SA0
	6SL3224-0BE21-1UA0, 6SL3224-0BE21-5UA0	1.1 kW ... 1.5 kW	6SL3202-0AE20-6SA0
FSB	6SL3224-0BE22-2□A0, 6SL3224-0BE23-0□A0	2.2 kW ... 3.0 kW	6SL3202-0AE21-1SA0
	6SL3224-0BE24-0□A0	4.0 kW	6SL3202-0AE21-4SA0
FSC	6SL3224-0BE25-5□A0	7.5 kW	6SL3202-0AE22-0SA0
	6SL3224-0BE27-5□A0, 6SL3224-0BE31-1□A0	11.0 kW ... 15.0 kW	6SL3202-0AE23-3SA0
FSD	6SL3224-0BE31-5□A0, 6SL3224-0BE31-8□A0	18.5 kW ... 22 kW	6SL3202-0AE24-6SA0
	6SL3224-0BE32-2□A0	30 kW	6SL3202-0AE26-2SA0
FSE	6SL3224-0BE33-0□A0, 6SL3224-0BE33-7□A0	37 kW ... 45 kW	6SL3202-0AE28-8SA0
FSF	6SL3224-0BE34-5□A0, 6SL3224-0BE35-5□A0	55 kW ... 75 kW	6SL3202-0AE31-5SA0
	6SL3224-0BE37-5□A0	90 kW	6SL3202-0AE31-8SA0
	6SL3224-0BE38-8UA0, 6SL3224-0BE41-1UA0	110 kW ... 132 kW	6SL3000-2CE32-3AA0
GX	6SL3224-0XE41-3UA0	160 kW	6SL3000-2CE32-8AA0
	6SL3224-0XE41-6UA0	200 kW	6SL3000-2CE33-3AA0
	6SL3224-0XE42-0UA0	250 kW	6SL3000-2CE34-1AA0

## Sine-wave filter for PM250 Power Module

Power Module		Power	Sine-wave filter
FSC	6SL3225-0BE25-5□A0	7.5 kW	6SL3202-0AE22-0SA0
	6SL3225-0BE27-5□ A0, 6SL3225-0BE31-1□A0	11.0 kW ... 15.0 kW	6SL3202-0AE23-3SA0
FSD	6SL3225-0BE31-5□A0, 6SL3225-0BE31-8□A0	18.5 kW ... 22 kW	6SL3202-0AE24-6SA0
	6SL3225-0BE32-2□A0	30 kW	6SL3202-0AE26-2SA0
FSE	6SL3225-0BE33-0□A0, 6SL3225-0BE33-7□A0	37 kW ... 45 kW	6SL3202-0AE28-8SA0
FSF	6SL3225-0BE34-5□A0, 6SL3225-0BE35-5□A0	55 kW ... 75 kW	6SL3202-0AE31-5SA0
	6SL3225-0BE37-5□A0	90 kW	6SL3202-0AE31-8SA0



### 3.4.6 Braking resistor

The braking resistor allows loads with a high moment of inertia to be quickly braked. The Power Module controls the braking resistor via its integrated braking module. Adjacent, as example, a braking resistor for PM240 and PM340 Power Modules, frame size FSA, which can be mounted below the device.



#### Braking resistors for PM240

Power Modules		Power	Braking Module	Braking resistor
FSA	6SL3224-0BE13-7UA0, 6SL3224-0BE15-5UA0, 6SL3224-0BE17-5UA0, 6SL3224-0BE21-1UA0, 6SL3224-0BE21-5UA0	0.37 kW ... 1.5 kW	---	6SE6400-4BD11-0AA0
FSB	6SL3224-0BE22-2□A0, 6SL3224-0BE23-0□A0, 6SL3224-0BE24-0□A0	2.2 kW ... 4.0 kW	---	6SL3201-0BE12-0AA0
FSC	6SL3224-0BE25-5□A0, 6SL3224-0BE27-5□A0, 6SL3224-0BE31-1□A0	7.5 kW ... 15.0 kW	---	6SE6400-4BD16-5CA0
FSD	6SL3224-0BE31-5□A0, 6SL3224-0BE31-8□A0, 6SL3224-0BE32-2□A0	18.5 kW ... 30 kW	---	6SE6400-4BD21-2DA0
FSE	6SL3224-0BE33-0□A0, 6SL3224-0BE33-7□A0	37 kW ... 45 kW	---	6SE6400-4BD22-2EA1
FSF	6SL3224-0BE34-5□A0, 6SL3224-0BE35-5□A0, 6SL3224-0BE37-5□A0	55 kW ... 90 kW	---	6SE6400-4BD24-0FA0
	6SL3224-0BE38-8UA0, 6SL3224-0BE41-1UA0	110 kW ... 132 kW	---	6SE6400-4BD26-0FA0
GX	6SL3224-0XE41-3UA0	160 kW	---	6SL300-1BE31-3AA0
	6SL3224-0XE41-6UA0, 6SL3224-0XE42-0UA0	200 kW ... 250 kW	6SL3300- 1AE32-5AA0	6SL3000-1BE32-5AA0

## Braking resistors for PM240-2, 200 V

Power Module		Power	Braking resistor
FSA	6SL3210-1PB13-0□L0, 6SL321□-1PB13-8□L0	0.55 kW ... 0.75 kW	JJY:023146720008
FSB	6SL3210-1PB15-5□L0, 6SL3210-1PB17-4□L0, 6SL321□-1PB21-0□L0	1.1 kW ... 2.2 kW	JJY:023151720007
FSC	6SL3210-1PB21-4□L0, 6SL321□-1PB21-8□L0	3 kW ... 4 kW	JJY:02 3163720018
	6SL3210-1PC22-2□L0, 6SL3210-1PC22-8□L0	5.5 kW ... 7.5 kW	JJY:023433720001
FSD	6SL3210-1PC24-2UL0, 6SL3210-1PC25-4UL0, 6SL3210-1PC26-8UL0	11 kW ... 18.5 kW	JJY:023422620002
FSE	6SL3210-1PC28-0UL0, 6SL3210-1PC31-1UL0	22 kW ... 30 kW	JJY:023423320001
FSF	6SL3210-1PC31-3UL0, 6SL3210-1PC31-6UL0, 6SL3210-1PC31-8UL0	37 kW ... 55 kW	JJY:023434020003

## Braking resistors for PM240-2, 400 V

Power Module		Power	Braking resistor
FSA	6SL3210-1PE11-8□L1, 6SL3210-1PE12-3□L1, 6SL3210-1PE13-2□L1, 6SL3210-1PE14-3□L1	0.55 kW ... 1.5 kW	6SL3201-0BE14-3AA0
	6SL321□-1PE16-1□L1, 6SL321□-1PE18-0□L1	2.2 kW ... 3.0 kW	6SL3201-0BE21-0AA0
FSB	6SL3210-1PE21-1□L0, 6SL3210-1PE21-4□L0, 6SL321□-1PE21-8□L0	4 kW ... 7.5 kW	6SL3201-0BE21-8AA0
FSC	6SL3210-1PE22-7□L0, 6SL321□-1PE23-3□L0	11 kW ... 15 kW	6SL3201-0BE23-8AA0
FSD	6SL3210-1PE23-8□L0, 6SL3210-1PE24-5□L0	18.5 kW ... 22 kW	JJY:023422620001
	6SL3210-1PE26-0□L0, 6SL3210-1PE27-5□L0	30 kW ... 37 kW	JJY:023424020001
FSE	6SL3210-1PE28-8□L0, 6SL3210-1PE31-1□L0	45 kW ... 55 kW	JJY:023434020001
FSF	6SL3210-1PE31-5□L0, 6SL3210-1PE31-8□L0,	75 kW ... 90 kW	JJY:023454020001
	6SL3210-1PE32-1□L0, 6SL3210-1PE32-5□L0	90 kW ... 132 kW	JJY:023464020001

## Braking resistors for PM240-2, 690 V

Power Module		Power	Braking resistor
FSD	6SL3210-1PH21-4□L0, 6SL3210-1PH22-0□L0, 6SL3210-1PH22-3□L0, 6SL3210-1PH22-7□L0, 6SL3210-1PH23-5□L0, 6SL3210-1PH24-2□L0	11 kW ... 37 kW	JJY:023424020002
FSE	6SL3210-1PH25-2□L0, 6SL3210-1PH26-2□L0	45 kW ... 55 kW	JJY:023434020002
FSF	6SL3210-1PH28-0□L0, 6SL3210-1PH31-0□L0	75 kW ... 90 kW	JJY:023464020002
	6SL3210-1PH31-2□L0, 6SL3210-1PH31-4□L0	110 kW ... 132 kW	JJY:023464020002

## Braking resistors for PM340, 1AC

Article number		Power	Braking resistor
FSA	6SL3210-1SB11-0□A0, 6SL3210-1SB12-3□A0, 6SL3210-1SB14-0□A0	0.12 kW ... 0.75 kW	6SE6400-4BC05-0AA0

### 3.4.7 Brake Relay

The brake relay has a switch contact (NO contact) to control the motor brake coil.

Article number: 6SL3252-0BB00-0AA0



### 3.4.8 Safe Brake Relay

The Safe Brake Relay controls a 24 V motor brake and monitors the brake control for a short-circuit or interrupted cable.



Article number: 6SL3252-0BB01-0AA0



## 3.5 Supported motor series

### Supported motors

The inverter is designed for the following motor series:

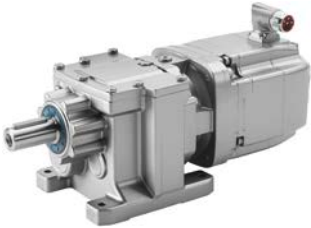
<p><b>SIMOTICS GP, SIMOTICS SD IEC motors</b></p>  <p>1LG6, 1LA7, 1LA9, 1LE1 and 1PC1 standard induction motors</p>	<p><b>SIMOTICS M main motors</b></p>  <p>1PH8 induction motors</p>
<p><b>SIMOTICS S 1FK7 permanent-magnet synchronous motors without encoder</b></p>  <p>1FK7 synchronous motors</p>	<p><b>SIMOTICS 1FG1 geared synchronous motors without encoder</b></p>  <p>1FG1 geared synchronous motor</p>
<p><b>Motors from other manufacturers</b> Standard induction motors Synchronous motors (on request)</p>	

### Operation with 1FK7 or 1FG1 synchronous motor without encoder

The control dynamic that can be achieved using a synchronous motor corresponds to that of an induction motor:

- Power-up time from standstill to rated speed  $\geq 1$  s
- Starting torque  $\leq 2 \times$  rated torque of the motor

Operation is intended for applications where increased energy efficiency is required when compared to an induction motor.

Some restrictions apply for operation:

Table 3-7 Restrictions for operation with encoderless synchronous motors

Property	Restriction
Power Module	PM240-2
Firmware	Firmware version $\geq$ FW V4.7
Applications	Suitable for applications for steady-state operation in the range of the rated motor speed: <ul style="list-style-type: none"> <li>• Conveyor drives</li> <li>• Pumps</li> <li>• Fans</li> </ul>
Speed of the motor	<ul style="list-style-type: none"> <li>• Speed <math>\leq</math> rated motor speed</li> </ul> <p>Operation is not permitted in field weakening.</p> <ul style="list-style-type: none"> <li>• In steady-state operation <math>\geq</math> 15% of the rated speed.</li> </ul> <p>For accelerating and reversing functions, speeds 0 ... 15% of the rated speed are permitted.</p>
Switching on when motor is rotating	The "flying restart" function is not possible.
Safety Integrated	Only "STO" is permitted by the safety functions integrated in the drive.
Ambient temperature of motor	$\leq 40^\circ \text{C}$ <p>The inverter monitors the motor using a temperature model. The temperature model presumes an ambient temperature of <math>40^\circ \text{C}</math>.</p> <p>In the case of higher ambient temperatures, the inverter will no longer be able to provide sufficient protection for the motor. If you operate the motor in ambient temperatures <math>&gt; 40^\circ \text{C}</math>, you must reduce the power of the motor sufficiently.</p> <p>Information on temperature-dependent power de-rating can be found in the motor manual.</p>

## Multi-motor drive

A multi-motor drive, i.e. simultaneously operating several motors connected to one inverter, is permissible for standard induction motors in installations according to IEC.



Further information is provided in the Internet:

Multi-motor drive (<http://support.automation.siemens.com/WW/view/en/84049346>)

For installations in compliance with UL, multi-motor drive operation is not permissible.

## 3.6 Tools to commission the inverter

### Operator panel

An operator panel is used to commission, troubleshoot and control the inverter, as well as to back up and transfer the inverter settings.



The Intelligent Operator Panel (IOP) is available for snapping on to the Control Unit or as handheld with a connection cable to the Control Unit. The graphics-capable plain text display of the IOP enables intuitive operation and diagnostics of the inverter.

The IOP is available in two versions:

- With European languages
- With Chinese, English and German

Additional information about the compatibility of the IOP and Control Units is available in the Internet:



Compatibility of the IOP and Control Units

(<http://support.automation.siemens.com/WW/view/en/67273266>)



The BOP-2 is an operator panel for snapping on to the Control Unit. The BOP-2 has a two-line display for operation and diagnostics of the inverter.

Operating Instructions of the BOP-2 and IOP operator panels:



Overview of the manuals (Page 507)

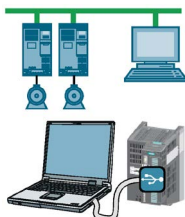

### STARTER and Startdrive PC tools

STARTER and Startdrive are PC tools that are used to commission, troubleshoot and control the inverter, as well as to back up and transfer the inverter settings. You can connect the PC with the inverter via USB or via the PROFIBUS / PROFINET fieldbus.

Connecting cable (3 m) between PC and inverter: Article number 6SL3255-0AA00-2CA0



### DVD article number

STARTER: 6SL3072-0AA00-0AG0

Startdrive: 6SL3072-4CA02-1XG0



### System requirements and download:

STARTER (<http://support.automation.siemens.com/WW/view/en/26233208>)

Startdrive (<http://support.automation.siemens.com/WW/view/en/68034568>)

### Help regarding operation:

STARTER videos (<http://www.automation.siemens.com/mcms/mc-drives/en/low-voltage-inverter/sinamics-g120/videos/Pages/videos.aspx>)

Startdrive tutorial (<http://support.automation.siemens.com/WW/view/en/73598459>)

*Description*

---

*3.6 Tools to commission the inverter*



## Installing

### 4.1 Overview of the inverter installation

#### Installing the inverter

##### Precondition



Before installation, please check:

- Are the required inverter components available?
  - Power Module
  - Control Unit
  - Accessories, e.g. line reactor or braking resistor
- Do you have the necessary tools and small parts/components required to install the inverter?

##### Procedure



To install the inverter, proceed as follows:

1. Install the accessories (reactors, filter or braking resistor) for the Power Module:
  -  Installing reactors, filters and braking resistors (Page 58)
2. Install the Power Module.
  -  Installing Power Modules (Page 60)
3. Install the Control Unit.
  -  Installing Control Unit (Page 90)

 You have installed all components of the inverter.

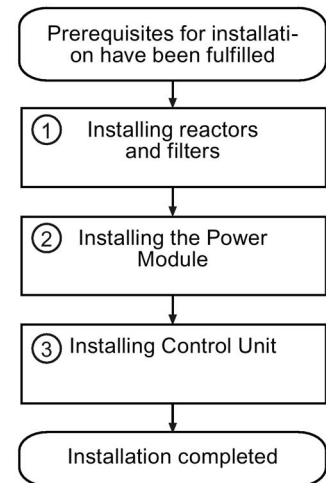

## 4.2 Connecting inverters in compliance with EMC

### 4.2.1 EMC-compliant connection of the converter

EMC-compliant installation of the inverter and motor are required in order to ensure disturbance-free operation of the drive.

Install and operate inverters with IP20 degree of protection in a closed control cabinet.

Inverters with degree of protection IP55 are suitable for installation outside a control cabinet.

An overview of control cabinet installation and cabling can be found in the following section. For further details, refer to the installation instructions of the Power Module.

The EMC-compliant connection of the inverter itself is described in the following sections.

### 4.2.2 Avoiding electromagnetic influence (EMI)

The inverters are designed for operation in industrial environments where high values of EMI are expected. Safe, reliable and disturbance-free operation is only guaranteed if the devices are installed by appropriately trained and qualified personnel.

#### Control cabinet design

- Establish all of the connections so that they are durable.
- Connect the metallic parts and components of the control cabinet to the frame of the cabinet through a good electrical connection.
  - Side panels
  - Rear panels
  - Cover plate
  - Base plates

Use the largest possible contact area or many individual screw connections.

- Connect the PE bar and the EMC shield bar to the control cabinet frame through a good electrical connection established through a large surface area.
- Connect all metal enclosures of the components installed in the cabinet with the control cabinet frame through a large surface area to ensure a good electrical connection. To achieve this, mount the components on a bare metal surface and mounting plate with good conductivity, which you then connect to the control cabinet frame through the largest possible surface area to establish a good connection, especially with the PE and EMC shield bars.

- For screw connections onto painted or anodized surfaces, establish a good conductive contact using one of the following methods:
  - Use special (serrated) contact washers that cut through the painted or anodized surface.
  - Remove the insulating coating at the contact locations.
- Equip the following components with interference suppression elements:
  - Coils of contactors
  - Relays
  - Solenoid valves
  - Motor holding brakes

Interference suppression elements include RC elements or varistors for AC-operated coils and freewheeling diodes for DC-operated coils.

Connect the interference suppression element directly at the coil.

### Radio interference suppression

- Connect interference suppressors to all contactors, relays, solenoid valves and motor holding brakes directly at the coil in order to dampen high-frequency radiation when these devices are switched off. Use RC elements or varistors for AC-operated coils and freewheeling diodes or varistors for DC-operated coils.

### Cable routing and shielding

#### Cables in the control cabinet

- Route the power cables of the drive so that there is a minimum clearance of 25 cm to signal and data cables. Power cables are line, DC link and motor cables – as well as connecting cables between the Braking Module and braking resistor. Alternatively, implement the separation using metal partitions connected to the mounting plate through a good electrical connection.
- Route power cables with low noise levels separately from power cables with high noise levels
  - Power cables with low noise level:
    - line cables from the line to the line filter
  - Power cables with high noise level:
    - cables between the line filter and inverter
    - DC link cables
    - cables between the Braking Module and braking resistor
    - motor cables
- Route the cables so that signal and data cables as well as power cables with low noise level only cross power cables with a high noise level at right angles.
- Keep all cables as short as possible.
- Route the cables as close as possible to grounded enclosure parts such as mounting plates or the cabinet frame.

- Route signal and data cables as well as the associated equipotential bonding cables parallel and as close to one another as possible.
- Connect the cable shields as closely as possible to the point where the cable enters the control cabinet.
- Connect the shields to the grounded enclosure at both ends with a good electrical connection through the largest possible surface area.
- Route incoming and outgoing cables/conductors within a zone (where unshielded single-conductor cables are used), twisted or in parallel and as close to one another as possible.
- Ground any unused conductors of signal and data cables at both ends.
- Signal and data cables should enter the cabinet only at one point (e.g. from below).

#### Cables outside the control cabinet

- Route the power cables of the drive so that there is a minimum clearance of 25 cm to signal and data cables.
- Use shielded motor cables.
- Use shielded signal and data cables.
- Route the shielded motor cable separately from the cables to the motor temperature sensors.

#### Cable shields

- For shielded cables, only use cables with finely-stranded, braided shields.
- Connect the shield at the grounded enclosure as well as at the EMC shield bar.
  - Connect the shields to the grounded enclosures through a large surface area at both ends of the cables to establish a low ohmic connection. Attach the shields to the appropriate EMC shield bars.
  - Immediately after the cable enters the cabinet, connect the cable shields to the EMC shield bar through a larger surface area to establish a low ohmic conduction.
- If possible, always route the cable shields without any interruptions.
- Only use metallic or metallized connectors for the plug connections for shielded data cables (e.g. PROFIBUS connection).

#### Further information



You can find additional information about the EMC installation guidelines under (<http://support.automation.siemens.com/WW/view/en/60612658>):

### 4.2.3 Laying EMC-compliant cables

#### Rules for cable installation to ensure EMC

- Use shielded cables for the following connections:
  - Motor and motor temperature sensor
  - Braking resistor (not available for all inverters)
  - Fieldbus
  - Inputs and outputs of the terminal strip
- Lay the cable shields with the largest possible surface at both ends:

Examples for EMC-compliant shield connection follow:

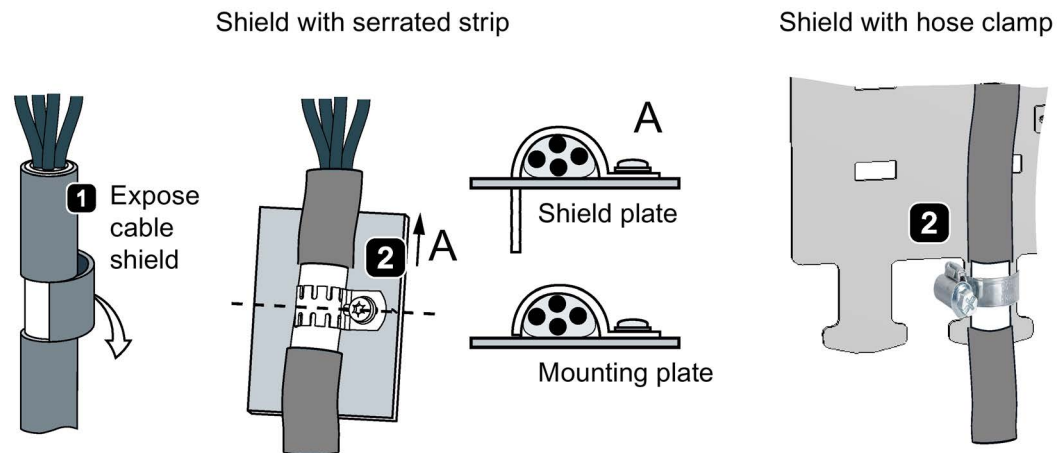

## 4.3 Installing reactors, filters and braking resistors

### Installing reactors, filters and braking resistors

The following supplementary components may be required depending on the Power Modules and the particular application:

- Line reactors
- Filter
- Braking resistors
- Brake Relay

Installing these components is described in the documentation provided.



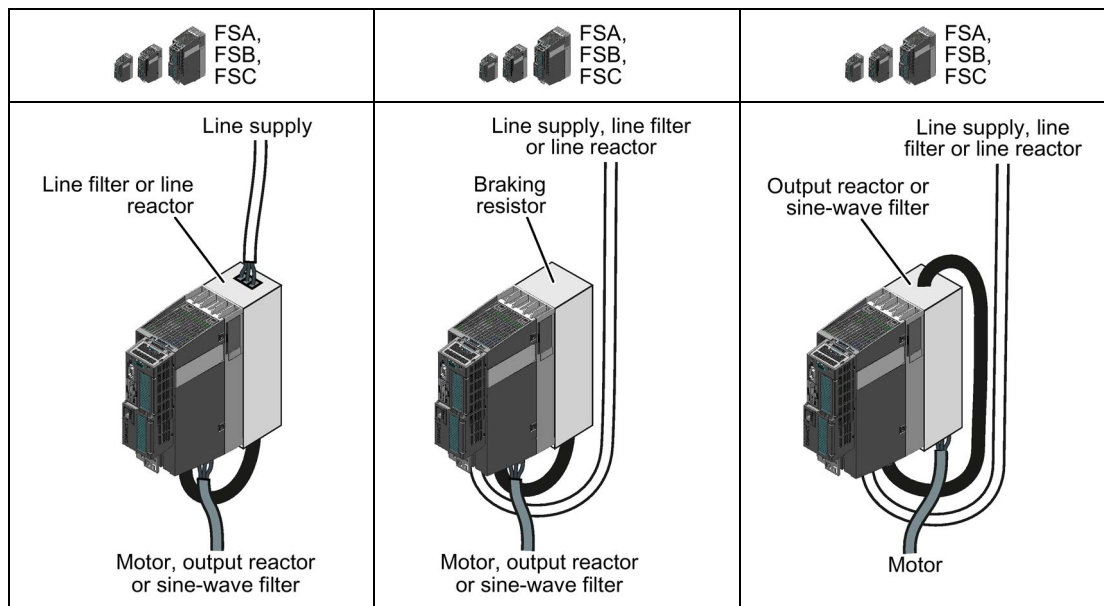

For frame sizes FSA, FSB and FSC, reactors, filters and braking resistors are available as base components. You can also install base components next to Power Modules.

For modules of the frame sizes FSA, FSB and FSC, reactors, filters and braking resistors are available as base components. An overview of the permitted base component combinations is provided below. You can also install base components next to the Power Module.

### Installing base components

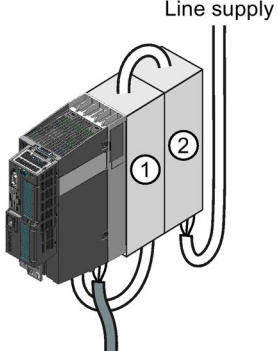
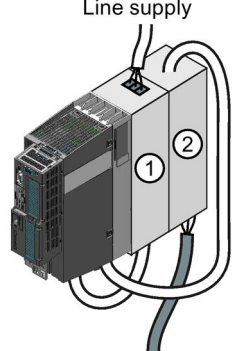
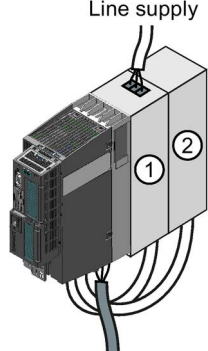
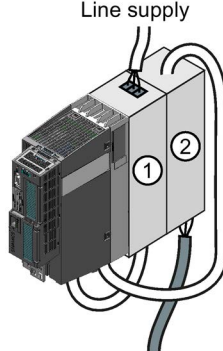

4.3 Installing reactors, filters and braking resistors

 FSA, FSB, FSC	 FSA, FSB, FSC	 <del>FSA</del> <del>FSB</del>	 <del>FSA</del>
<p>① Line filter</p> <p>② Line reactor</p> <p>Line supply</p>  <p>Motor, output reactor or sine-wave filter</p>	<p>① Line filter or line reactor</p> <p>② Output reactor</p> <p>Line supply</p>  <p>Motor</p>	<p>① Line filter or line reactor</p> <p>② Braking resistor</p> <p>Line supply</p>  <p>Motor, output reactor or sine-wave filter</p>	<p>① Line filter or line reactor</p> <p>② Sine-wave filter</p> <p>Line supply</p>  <p>Motor</p>

## 4.4 Installing Power Modules

### 4.4.1 Basic installation rules

#### Installing Power Modules

The following is required to correctly install a Power Module:

- Install the Power Module in a control cabinet.
- Install the Power Module vertically with the line and motor connections facing downwards.

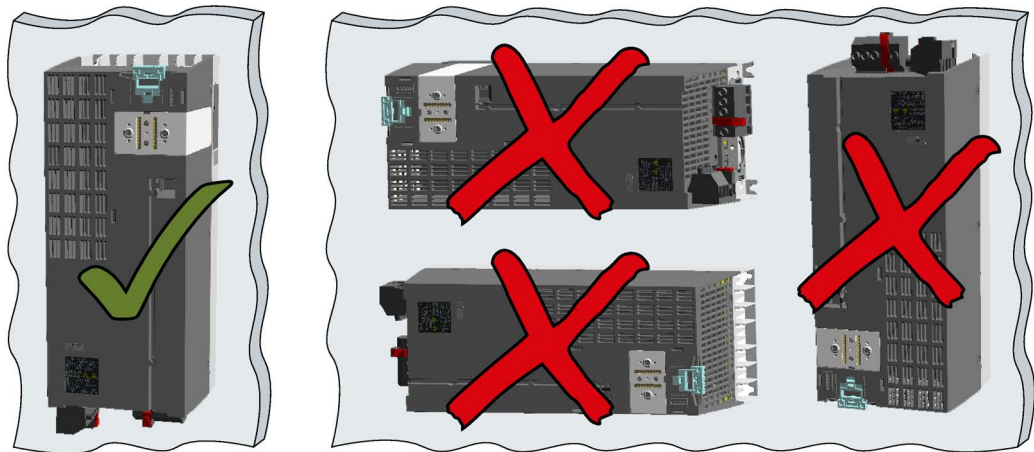

- Comply with the installation regulations specified in the following sections:
  - Minimum clearances to other components
  - Fixing elements
  - Tightening torques for fixing elements

#### Mounting Power Modules in push through technology (PT Power Module)

We recommend that you use the optional mounting frames when installing PT Power Modules in a control cabinet. This mounting frame includes the necessary seals and frame to ensure compliance with degree of protection IP54.

If you do not use the optional mounting frames, then you must ensure that the required degree of protection is complied with using other appropriate measures.

You must mount the inverter on unpainted metal surfaces in order to comply with EMC requirements.



**Procedure**

1 Proceed as follows to correctly install the Power Module:

1. Prepare the cutout and the mounting holes for the Power Module and the mounting frame corresponding to the dimensioned drawings of the mounting frame.

Also note that the PT Power Modules must be vertically mounted with the line and motor connections facing downwards.

2. Position the mounting frame at the rear of the control cabinet and attach it to the control cabinet by tightening the corresponding screws by hand.
3. Attach the seal to the inner side of the control cabinet.
4. Fix the inverter, and first tighten all of the fixing screws by hand.
5. Tighten the screws with a torque of 3.5 Nm.

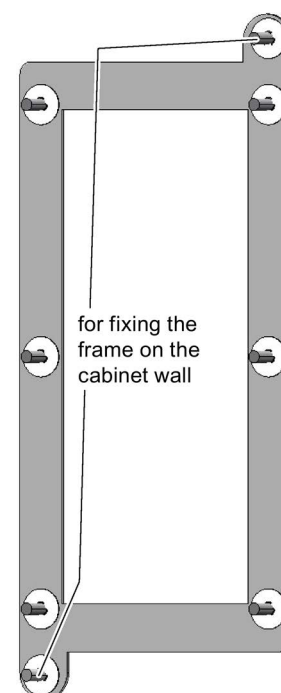

Mounting frame

- You have correctly installed the Power Module.

**Protection against the spread of fire**

The built-in units may be operated only in closed housings or in higher-level control cabinets with closed protective covers, and when all of the protective devices are used. The installation of the built-in units in a metal control cabinet or protection with another equivalent measure must prevent the spread of fire and emissions outside the control cabinet.

Wall mounting units may be operated outside the control cabinet.

**Protection against condensation or electrically conductive contamination**

Protect the inverter, e.g. by installing it in a control cabinet with degree of protection IP54 according to IEC 60529 or NEMA 12. Further measures may be necessary for particularly critical operating conditions.

If condensation or conductive pollution can be excluded at the installation site, a lower degree of control cabinet protection may be permitted.

### 4.4.2 Dimensioned drawings, drilling dimensions for the PM240-2 Power Module, IP20

The following dimensioned drawings and drilling patterns are not to scale.

Table 4- 1 Mounting dimensions

Frame size	Width <sup>1)</sup> (mm)	Height (mm)				Depth (mm)
		Total	Shield plate at the top	Power Module	Shield plate at the bottom	
FSA	73	276	---	196	80	165
FSB	100	370	---	292	78	165
FSC	140	432	---	355	77	165
FSD	200	707.5	83.5	472	152	237
FSE	275	850	122	551	177	237
FSF	305	1107	142	708	257	357

<sup>1)</sup> The Power Modules can be mounted and operated side-by-side. For tolerance reasons, we recommend a lateral clearance of approx. 1 mm.

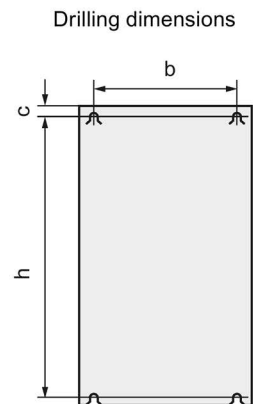
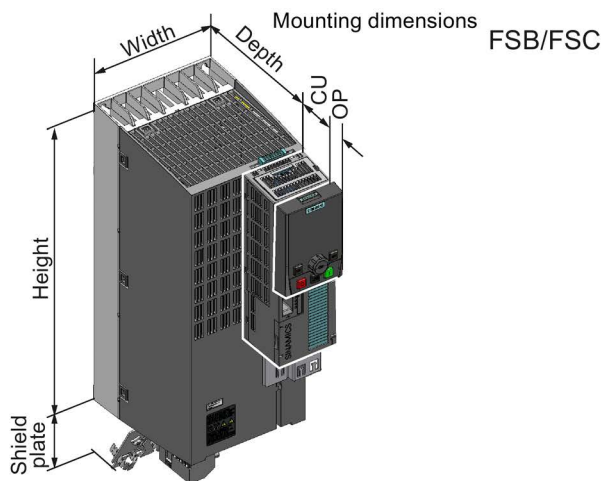
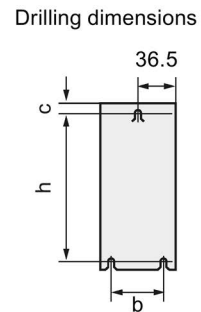
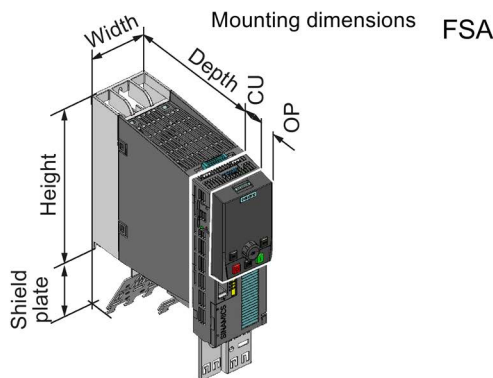

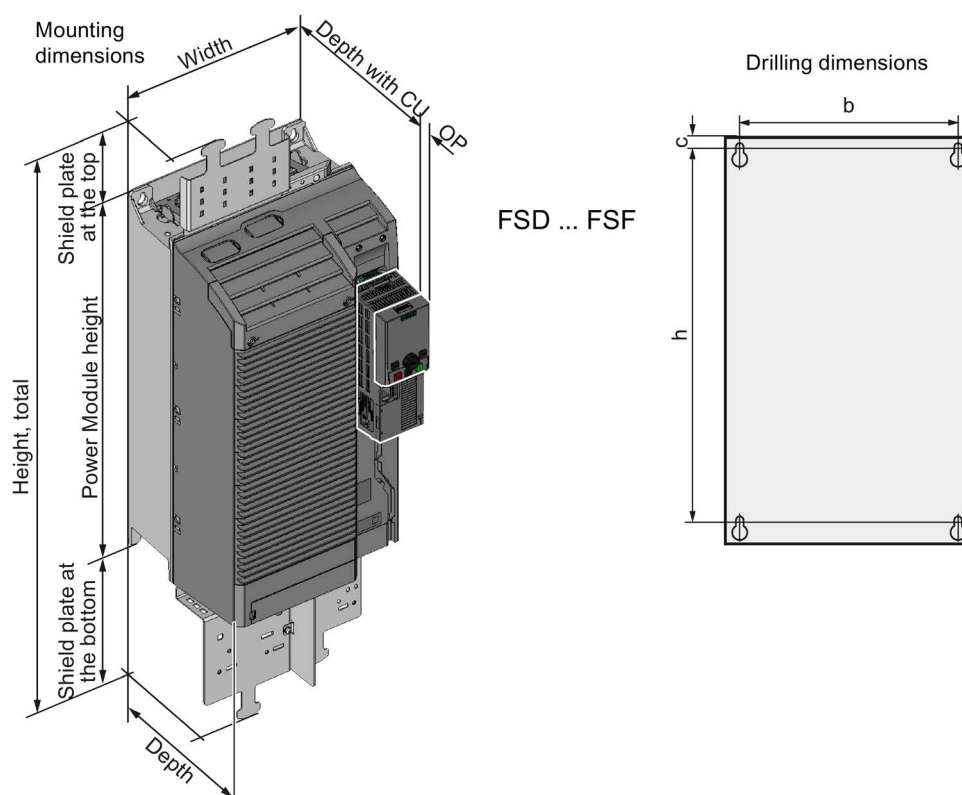

### Depth with Control Unit and Operator Panel

FSA ... FSC:

- with Control Unit: + 41 mm
- With Control Unit and blanking cover / BOP-2: + 52 mm
- With Control Unit and IOP: + 63 mm

FSD ... FSF

- with Control Unit: + 0 mm
- With Control Unit and blanking cover / BOP-2: + 10 mm
- With Control Unit and IOP: + 21 mm

### Drilling dimensions and cooling air clearances

Table 4- 2 Drilling dimensions, cooling clearances and fixing

Frame size	Drilling dimensions (mm)			Cooling air clearances (mm)			Fixing
	a	b	c	Top	Bottom	Front	Torque [Nm]
FSA	186	62.3	6	80	100	100	3 x M4 / 2.5
FSB	281	80	6	80	100	100	4 x M4 / 2.5
FSC	343	120	6	80	100	100	4 x M5 / 3.0
FSD	430	170	15	300	350	100	4 x M6 / 6.0
FSE	509	230	11	300	350	100	4 x M6 / 10
FSF	680	270	13	300	350	100	4 x M8 / 25

### 4.4.3 Dimensioned drawings, drilling dimensions for the PM240-2 Power Module, PT inverter

The following dimensioned drawings and drilling patterns are not to scale.

Table 4-3 Mounting dimensions

Frame size	Width <sup>1)</sup> (mm)	Height (mm)		Depth <sup>2)</sup> (mm)		
			with shield plate		T1	T2
FSA	126	238	322	171	117.7	53.1
FSB	154	345	430	171	117.7	53.1
FSC	200	411	500	171	117.7	53.1

- 1) The Power Modules can be mounted side-by-side. For tolerance reasons, we recommend a lateral clearance of 1 mm.
- 2) Wall thickness of the control cabinet  $\leq 3.5$  mm

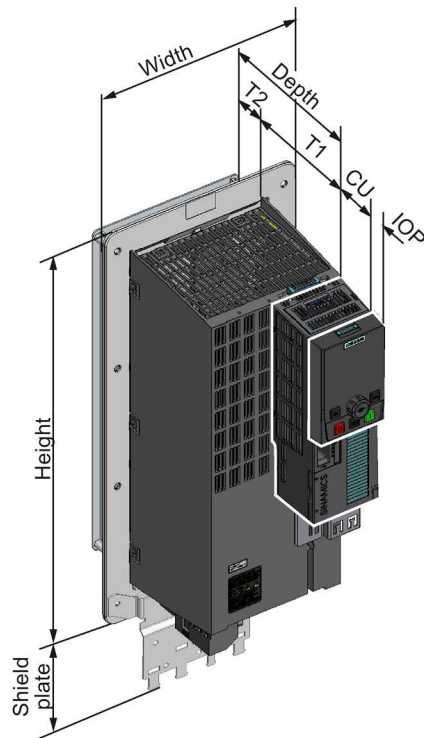

Switch cabinet cutout and mounting holes for PT devices

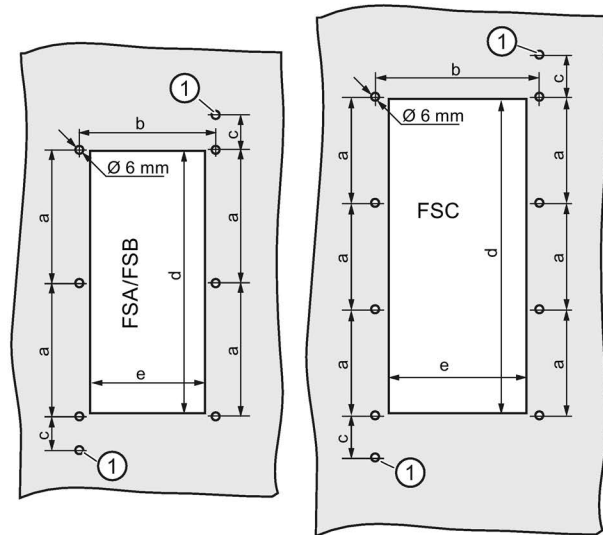

① Mounting hole for the mounting frame

#### Depth with Control Unit and Operator Panel

FSA ... FSC:

- with Control Unit: + 41 mm
- With Control Unit and blanking cover / BOP-2: + 52 mm
- With Control Unit and IOP: + 63 mm

Table 4- 4 Drilling dimensions, cooling clearances and fixing

Frame size	Drilling dimensions and dimensions for the control cabinet cutout (mm)					Cooling air clearances (mm)			Fixing
	a	b	c	d	e	Top	Bottom	Front	
FSA	103	106	27	198	88	80	100		8 x M5 / 3.5
FSB	147.5	134	34.5	304	116	80	100		8 x M5 / 3.5
FSC	123	174	30.5	365	156	80	100		10 x M5 / 3.5

### 4.4.4 Dimensioned drawings, drilling dimensions for the PM240 Power Module, FSA ... FSF

The following dimensioned drawings and drilling patterns are not to scale.

Table 4- 5 Mounting dimensions

Frame size	Width <sup>1)</sup> (mm)	Height (mm)		Depth (mm)
			with shield connection kit	
FSA	73	173	271	145
FSB without/with filter	153	270	360	165
FSC without/with filter	189	334	432	185
FSD without filter	275	419	542	204
FSD with filter	275	512	635	204
FSE without filter	275	499	622	204
FSE with filter	275	635	758	204
FSF without filter	350	634	792	316
FSF with filter	350	934	1092	316

1) The Power Modules can be mounted and operated side-by-side. For tolerance reasons, we recommend a lateral clearance of approx. 1 mm.

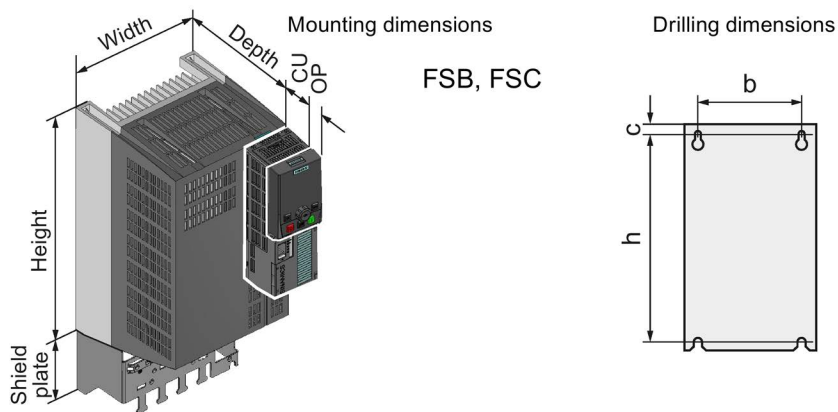
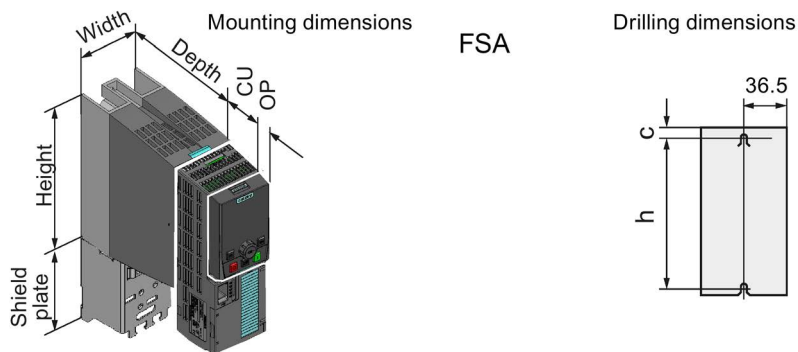

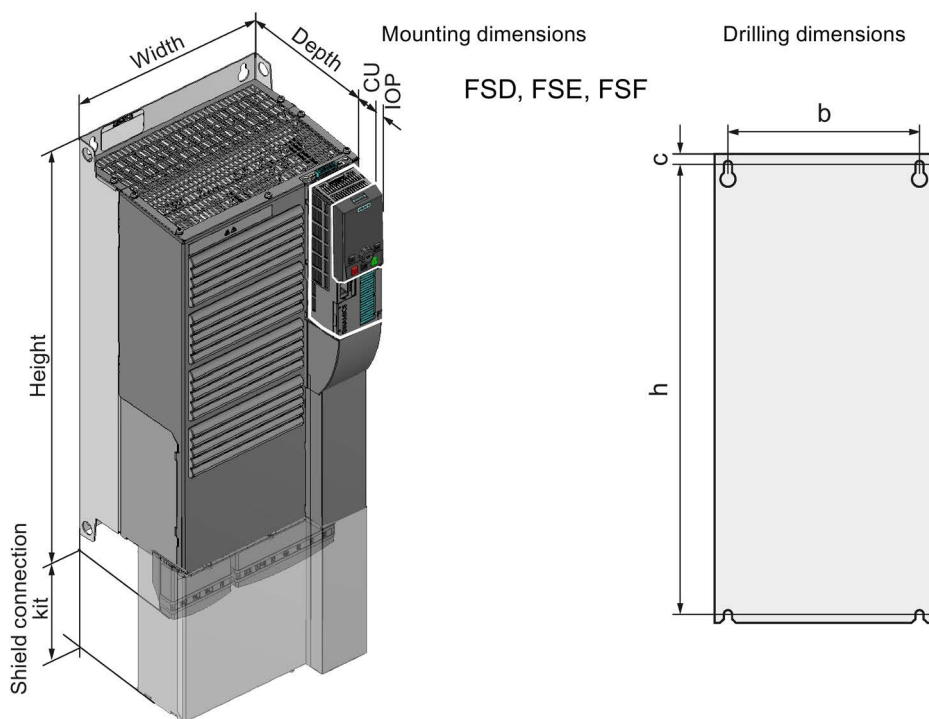

**Depth with Control Unit and Operator Panel**

- with Control Unit: + 41 mm
- With Control Unit and blanking cover / BOP-2: + 52 mm
- With Control Unit and IOP: + 63 mm

Table 4- 6 Drilling dimensions, cooling clearances and fixing

Frame size	Drilling dimensions (mm)			Cooling air clearances (mm)			Mounting
	b	h	c	Top	Bottom	Front	Screws/torque (Nm)
FSA	36.5	160	7.5	100	100	65	2 x M4 / 2.5
FSB without/with filter	133	258	5.5	100	100	65	4 x M4 / 2.5
FSC without/with filter	167	323	6	125	125	65	4 x M5 / 3.0
FSD without filter	235	325	11	300	300	65	4 x M6 / 6.0
FSD with filter	235	419	11	300	300	65	4 x M6 / 6.0
FSE without filter	235	405	11	300	300	65	4 x M6 / 10
FSE with filter	235	541	11	300	300	65	4 x M6 / 10
FSF without filter	300	598	11	350	350	65	4 x M8 / 13
FSF with filter	300	898	11	350	350	65	4 x M8 / 13

### 4.4.5 Dimensioned drawings, drilling dimensions for the PM240 Power Module, FSGX

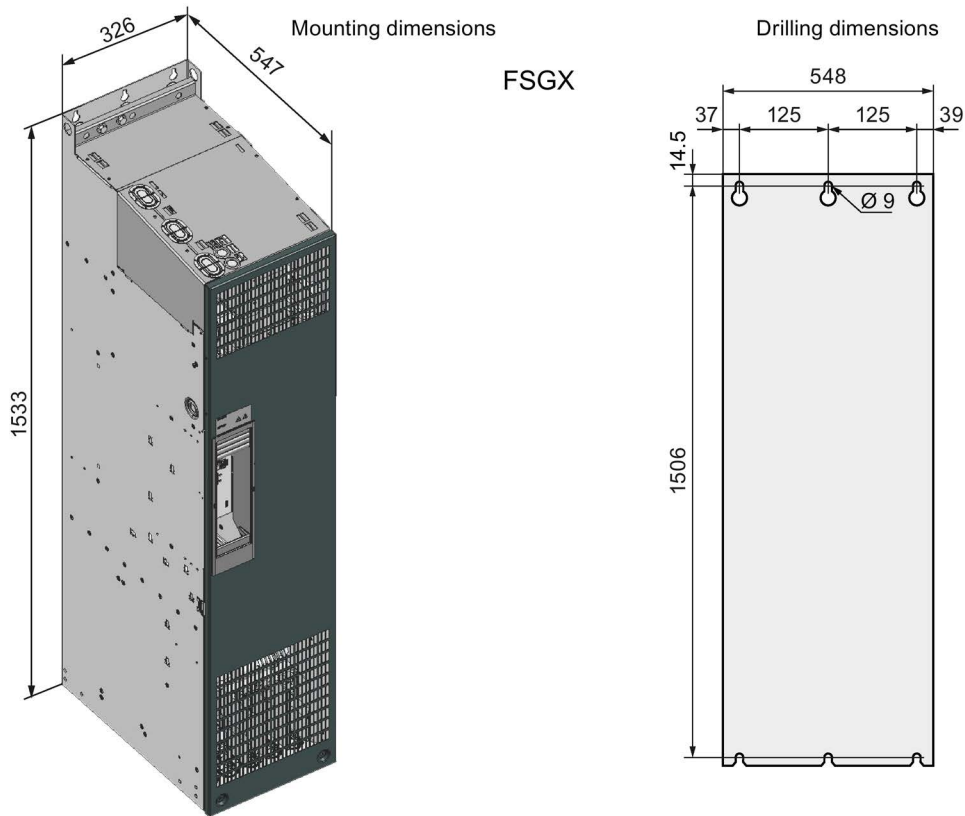

Mount the Power Module with the following clearances to other devices:

- Top: 250 mm
- Bottom: 150 mm
- Lateral: no clearance required for thermal reasons.

Fasten the Power Module with six M8 screws with a tightening torque of 13 Nm.



### 4.4.6 Dimensioned drawings, drilling dimensions for the PM230 Power Module, IP20

The following dimensioned drawings and drilling patterns are not to scale.

Table 4- 7 Mounting dimensions

Frame size	Width <sup>1)</sup> (mm)	Height (mm)		Depth (mm)
			with shield plate	
FSA	73	196	276	165
FSB without/with filter	100	292	370	165
FSC without/with filter	140	355	432	165
FSD without filter	275	419	542	204
FSD with filter	275	512	635	204
FSE without filter	275	499	622	204
FSE with filter	275	635	758	204
FSF without filter	350	634	792	316
FSF with filter	350	934	1092	316

<sup>1)</sup> The Power Modules can be mounted and operated side-by-side. For tolerance reasons, we recommend a lateral clearance of approx. 1 mm.

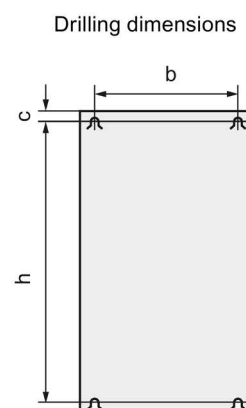
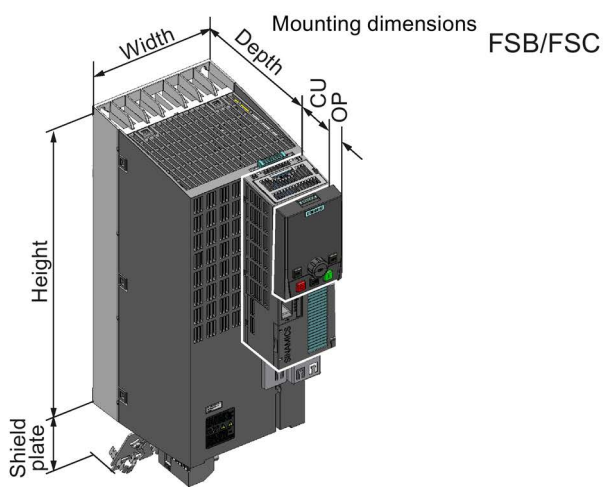
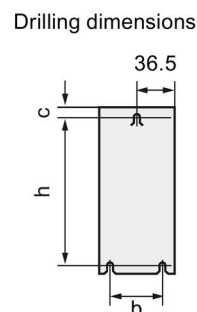
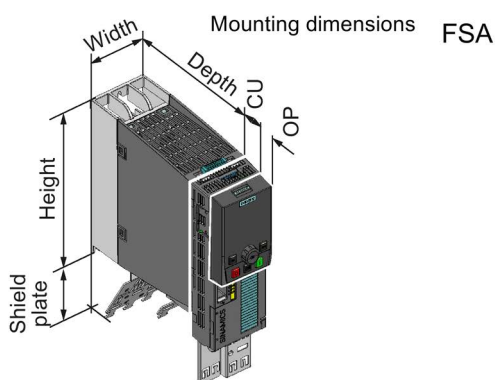

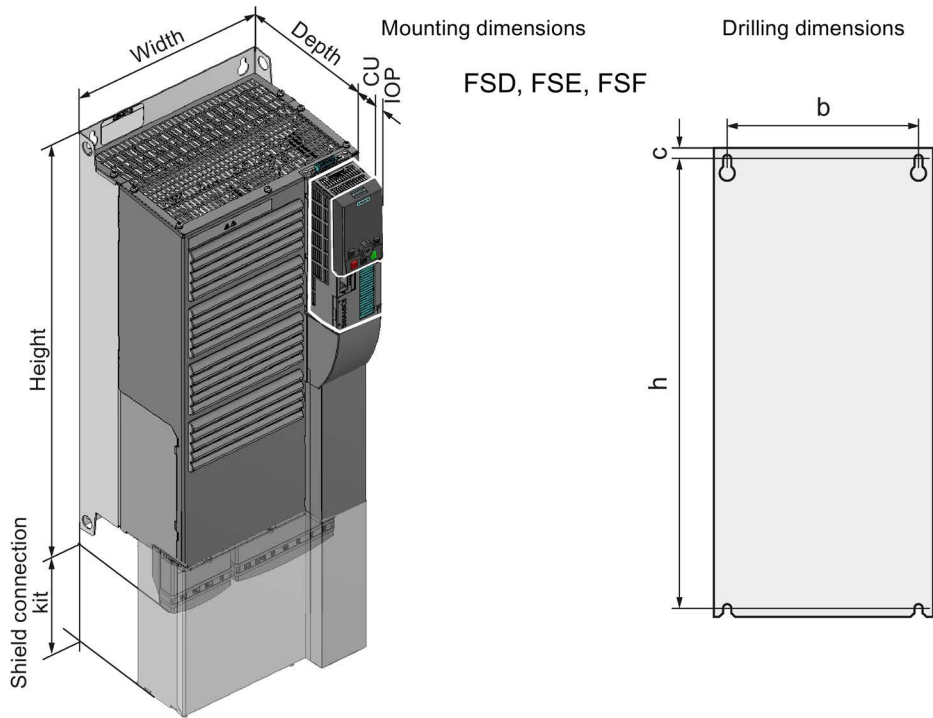

**Depth with Control Unit and Operator Panel**

- with Control Unit: + 41 mm
- With Control Unit and blanking cover / BOP-2: + 52 mm
- With Control Unit and IOP: + 63 mm

Table 4- 8 Drilling dimensions, cooling clearances and fixing

Frame size	Drilling dimensions (mm)			Cooling air clearances (mm)			Mounting Screws / torque (Nm)
	b	h	c	Top	Bottom	Front	
FSA	62.3	186	6	80	100	---	2 x M4 / 2.5
FSB without/with filter	80	281	6	80	100	---	4 x M4 / 2.5
FSC without/with filter	120	343	6	80	100	---	4 x M5 / 3.0
FSD without filter	235	325	11	300	300	100	4 x M6 / 6.0
FSD with filter	235	419	11	300	300	100	4 x M6 / 6.0
FSE without filter	235	405	11	300	300	100	4 x M6 / 10
FSE with filter	235	451	11	300	300	100	4 x M6 / 10
FSF without filter	300	598	11	350	350	100	4 x M8 / 13
FSF with filter	300	899	11	350	350	100	4 x M8 / 13

### 4.4.7 Dimensioned drawings, drilling dimensions for the PM230 Power Module, PT inverter

The following dimensioned drawings and drilling patterns are not to scale.

Table 4- 9 Mounting dimensions

Frame size	Width <sup>1)</sup> (mm)	Height (mm)		Depth <sup>2)</sup> (mm)		
			with shield plate		T1	T2
FSA	126	238	322	171	117.7	53.1
FSB	154	345	430	171	117.7	53.1
FSC	200	411	500	171	117.7	53.1

- 1) The Power Modules can be mounted side-by-side. For tolerance reasons, we recommend a lateral clearance of 1 mm.
- 2) Wall thickness of the control cabinet  $\leq 3.5$  mm

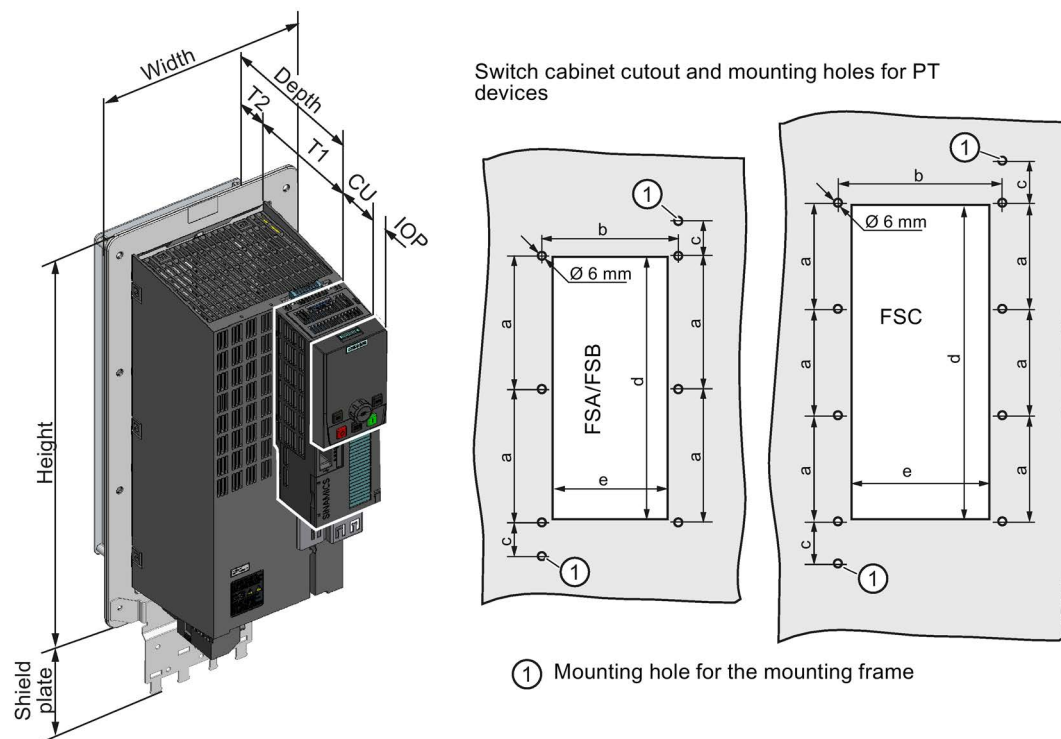

#### Depth with Control Unit and Operator Panel

FSA ... FSC:

- with Control Unit: + 41 mm
- With Control Unit and blanking cover / BOP-2: + 52 mm
- With Control Unit and IOP: + 63 mm

Table 4- 10 Drilling dimensions, cooling clearances and fixing

Frame size	Drilling dimensions and dimensions for the control cabinet cutout (mm)					Cooling air clearances (mm)			Fixing
	a	b	c	d	e	Top	Bottom	Front	
FSA	103	106	27	198	88	80	100		8 x M5 / 3.5
FSB	147.5	134	34.5	304	116	80	100		8 x M5 / 3.5
FSC	123	174	30.5	365	156	80	100		10 x M5 / 3.5

### 4.4.8 Dimensioned drawings, drilling dimensions for the PM250 Power Module

The following dimensioned drawings and drilling patterns are not to scale.

Table 4- 11 Mounting dimensions

Frame size	Width <sup>1)</sup> (mm)	Height (mm)		Depth (mm)
			with shield connection kit	
FSC without/with filter	189	334	432	185
FSD without filter	275	419	542	204
FSD with filter	275	512	635	204
FSE without filter	275	499	622	204
FSE with filter	275	635	758	204
FSF without filter	350	634	792	316
FSF with filter	350	934	1092	316

<sup>1)</sup> The Power Modules can be mounted and operated side-by-side. For tolerance reasons, we recommend a lateral clearance of approx. 1 mm.

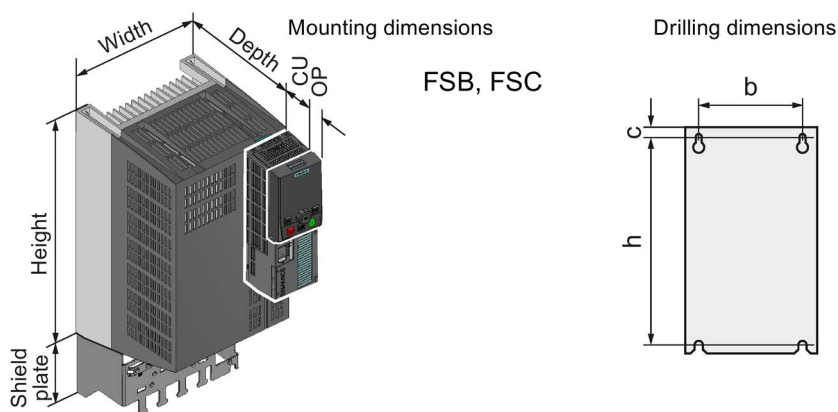

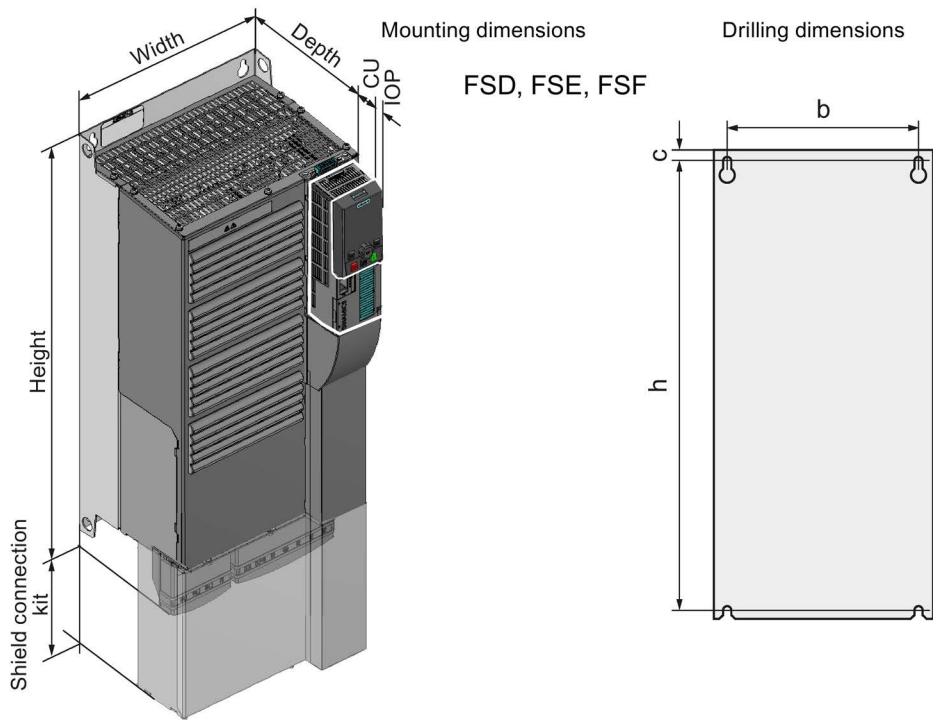

**Depth with Control Unit and Operator Panel**

- with Control Unit: + 41 mm
- With Control Unit and blanking cover / BOP-2: + 52 mm
- With Control Unit and IOP: + 63 mm

Table 4- 12 Drilling dimensions, cooling clearances and fixing

Frame size	Drilling dimensions (mm)			Cooling air clearances (mm)			Mounting
	b	h	c	Top	Bottom	Front	Screws/torque (Nm)
FSC without/with filter	167	323	6	125	125	65	4 x M5 / 3.0
FSD without filter	235	325	11	300	300	65	4 x M6 / 6.0
FSD with filter	235	419	11	300	300	65	4 x M6 / 6.0
FSE without filter	235	405	11	300	300	65	4 x M6 / 10
FSE with filter	235	541	11	300	300	65	4 x M6 / 10
FSF without filter	300	598	11	350	350	65	4 x M8 / 13
FSF with filter	300	898	11	350	350	65	4 x M8 / 13

#### **4.4.9 Dimensioned drawings, drilling dimensions for the PM260 Power Module**

The dimensioned drawings and drilling dimensions for the PM260 Power Module are available in the Internet:



Installation Guide for the PM260 Power Module

(<https://support.industry.siemens.com/cs/ww/en/view/79109730>)

### 4.4.10 Dimensioned drawings, drilling dimensions for the PM340 Power Module

The following dimensioned drawings and drilling patterns are not to scale.

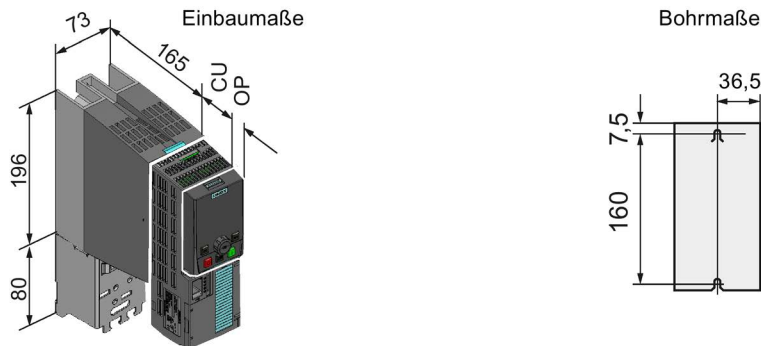

Image 4-1 Mounting dimensions and drilling dimensions (mm)

The Power Modules can be mounted and operated side-by-side. For tolerance reasons, we recommend a lateral clearance of approx. 1 mm.

#### Cooling clearances and fastening

- Top cooling clearance: 100 mm
- Bottom cooling clearance: 100 mm
- Front cooling clearance: 65 mm
- For fastening: 2 x M4 / 2.5 Nm

#### Depth with Control Unit and Operator Panel

- with Control Unit: 186 mm
- With Control Unit and blanking cover / BOP-2: 197 mm
- With Control Unit and IOP: 208 mm



## 4.5 Connecting the line supply, motor, and inverter components

### 4.5.1 Permissible line supplies

---

**Note****Restrictions for installation altitudes above 2000 m**

Above an installation altitude of 2000 m, the permissible line supplies are restricted.



Restrictions for special ambient conditions (Page 475)

---

**Note****Line requirement**

The machine manufacturer must ensure that in operation the voltage drop between the transformer input terminals and the inverter with rated values is less than 4%.

---

The inverter is designed for the following power distribution systems according to IEC 60364-1 (2005).

### TN line system

A TN line system transfers the PE protective conductor to the installed plant or system using a cable.

Generally, in a TN line system the neutral point is grounded. There are versions of a TN system with a grounded line conductor, e.g. with grounded L1.

A TN line system can transfer the neutral conductor N and the PE protective conductor either separately or combined.

#### Inverter operated on a TN line system

- Inverter with integrated or external line filter:
  - Operation on TN line systems with grounded neutral point permissible.
  - Operation on TN line systems with grounded line conductor not permissible.
- Inverter without line filter:
  - Operation on all TN line systems  $\leq 600$  V permissible
  - Operation on TN line systems  $> 600$  V and grounded neutral point permissible.
  - Operation on TN line systems  $> 600$  V and grounded line conductor not permissible.

#### Examples for inverters connected to a TN line system

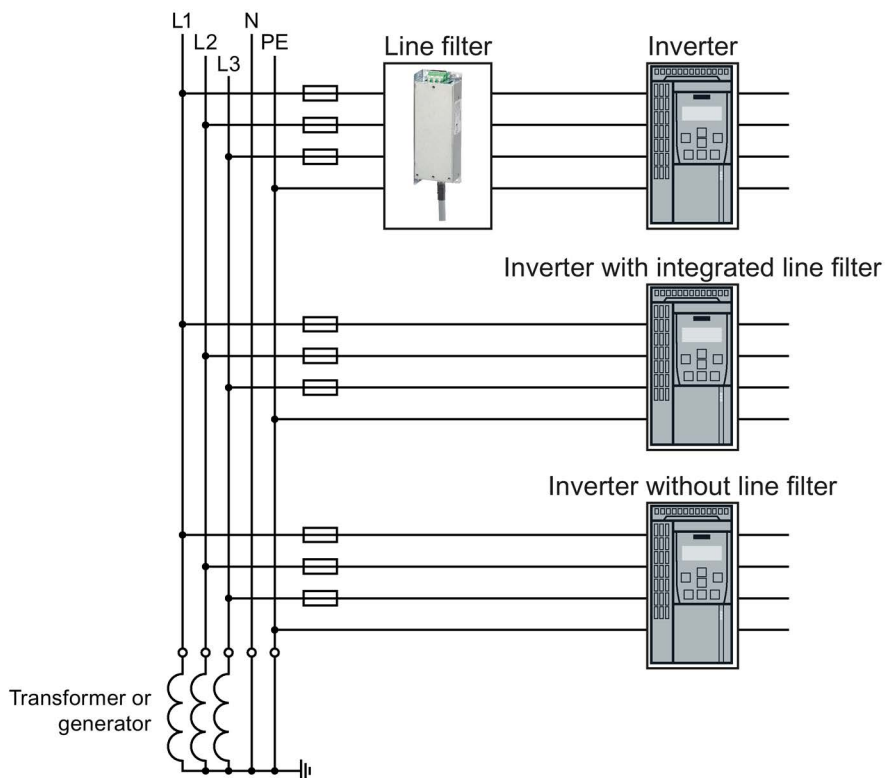

Image 4-2 TN line supply with separate transfer of N and PE and with a grounded neutral point

## TT line system

In a TT line system, the transformer grounding and the installation grounding are independent of one another.

There are TT systems with and without transfer of the neutral conductor N.

### Inverter operated on a TT line system

- Inverter with integrated or external line filter:
  - Operation on TT line systems with grounded neutral point permissible.
  - Operation on TT line systems without grounded neutral point not permissible.
- Inverter without line filter:
  - Operation on all TT line systems permissible.
- For installations in compliance with IEC, operation on a TT line system is permissible. For installations in compliance with UL, operation on a TT line system is not permissible.

### Examples for inverters connected to a TT line system

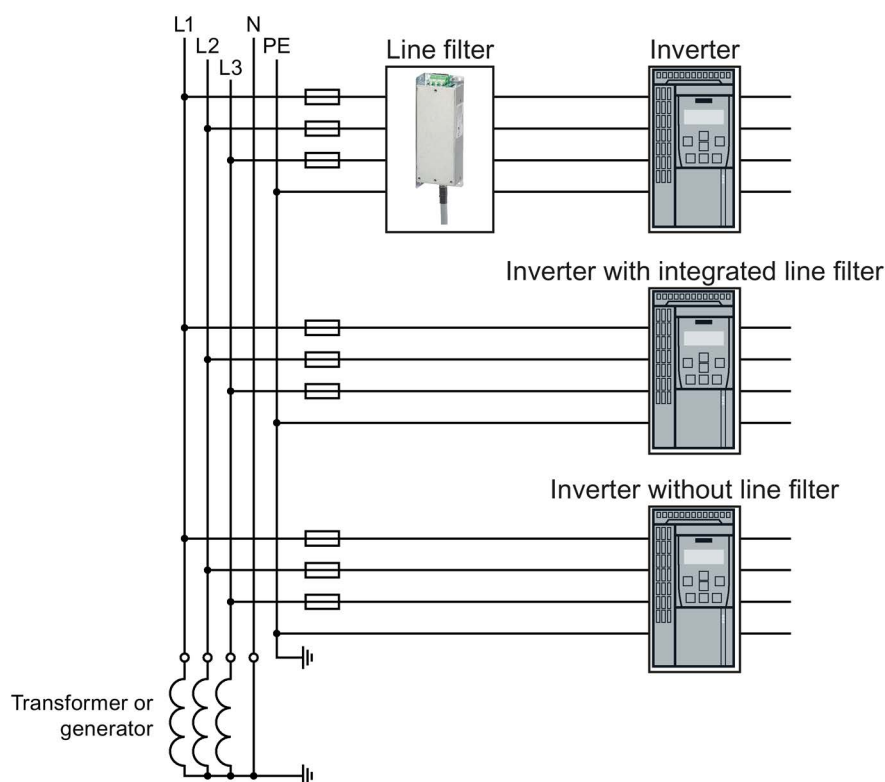

Image 4-3 TT line system with neutral conductor N and with grounded neutral point

### IT system

In an IT line system, all of the conductors are insulated with respect to the PE protective conductor – or connected to the PE protective conductor through an impedance.

There are IT systems with and without transfer of the neutral conductor N.

#### Inverter operated on an IT line system

- Inverters with integrated line filter:
  - Operation on IT line systems not permissible.
- Inverter without line filter:
  - Operation on all IT line systems permissible.

#### Example for inverters connected to an IT line system

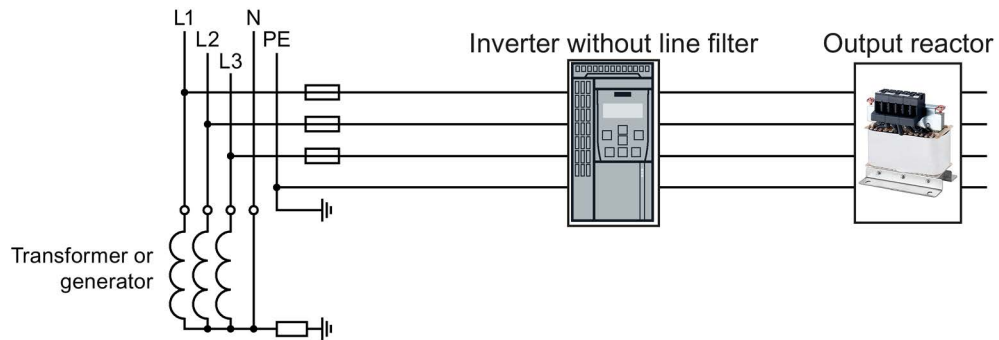

Image 4-4 IT line supply where the neutral conductor N is transferred and with impedance with respect to the PE protective conductor

#### Behavior of the inverter when a ground fault occurs

In some instances, even for a ground fault, the inverter should still remain functional. In cases such as these, you must install an output reactor. This prevents an overcurrent trip or damage to the drive.

### 4.5.2 Dimensioning the protective conductor



#### ! WARNING

##### Danger to life caused by high leakage currents for an interrupted protective conductor

The drive components conduct a high leakage current via the protective conductor. Touching conductive parts when the protective conductor is interrupted can result in death or serious injury.

- Lay the protective conductor as specified.

## Laying the protective conductor

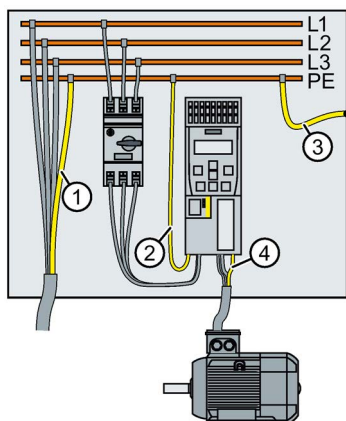

- ① For the protective conductor of the line-system connection within a machine or system, the following applies:
1. Observe the local regulations for protective conductors subject to an increased leakage current at the site of operation.
  2. Lay the protective conductor as follows:
    - For permanent connection, the protective conductor must fulfill at least one of the following conditions:
      - The protective conductor is laid so that it is protected against mechanical damage over its complete length.<sup>1)</sup>
      - In a multi-core cable, the protective conductor core has a cross-section of  $\geq 2.5 \text{ mm}^2 \text{ Cu}$ .
      - In a single conductor, the protective conductor has a cross-section of  $\geq 10 \text{ mm}^2 \text{ Cu}$ .
      - The protective conductor consists of two conductors with the same cross-section.
    - For the connection of a multi-core cable using an industrial plug connector according to EN 60309, the protective conductor must have a cross-section of  $\geq 2.5 \text{ mm}^2 \text{ Cu}$ .
- <sup>1)</sup> Cables laid within control cabinets or closed machine housings are considered to be adequately protected against mechanical damage.
- ② The protective conductor must have at least the same cross-section as the line cable of the inverter.  
For a cross-section of the line cable  $\geq 6 \text{ mm}^2$ , cross-section =  $6 \text{ mm}^2$  suffices for the protective conductor.
- ③ The protective conductor for the connection of the PE busbar to the control cabinet housing must have at least the same cross-section as the line supply cable of the machine or system (①).  
For a cross-section of the line supply cable  $\geq 6 \text{ mm}^2$ , cross-section =  $6 \text{ mm}^2$  suffices for the protective conductor.
- ④ The protective conductor must have at least the same cross-section as the motor cable of the inverter.

### 4.5.3 Connecting the inverter

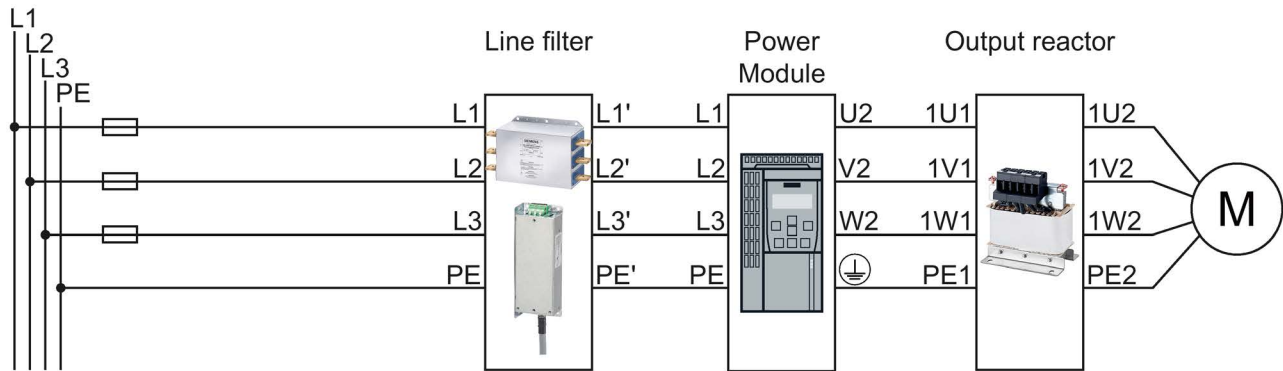

Image 4-5 Connecting the PM230 IP20 and push-through Power Module

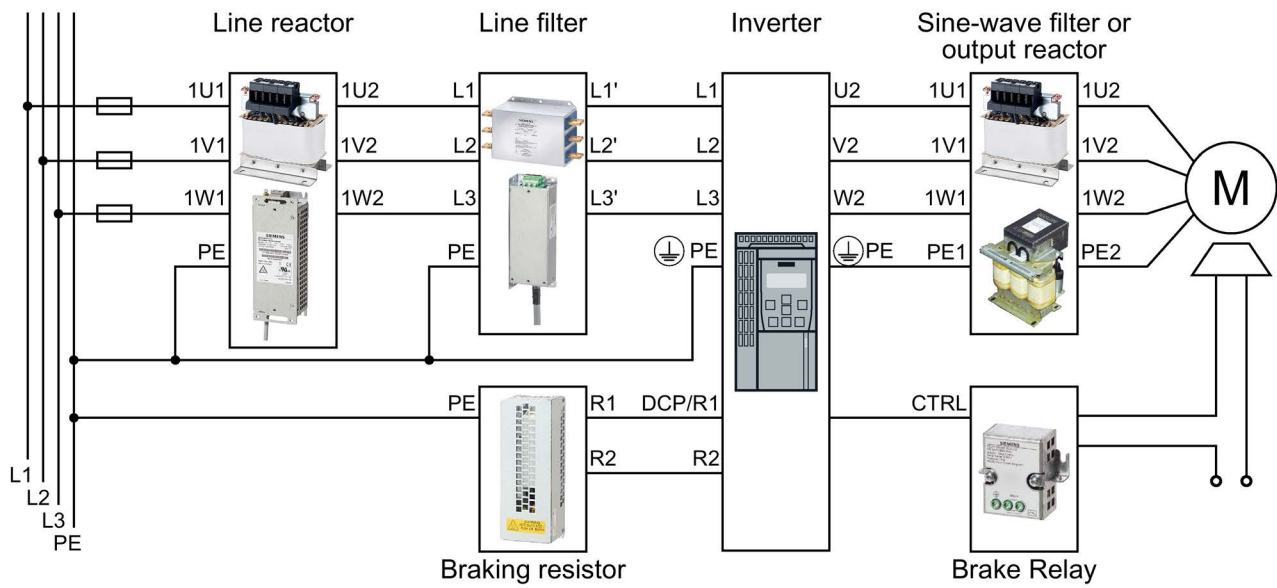

Image 4-6 Connecting the PM240, PM240-2 IP20 and push-through Power Modules

4.5 Connecting the line supply, motor, and inverter components

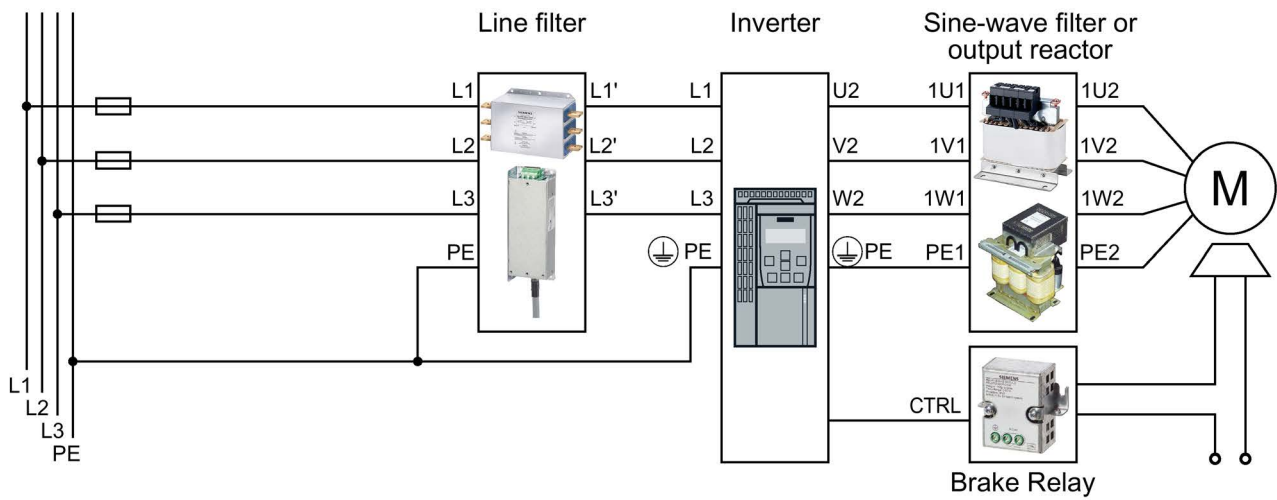

Image 4-7 Connecting the PM250 Power Module

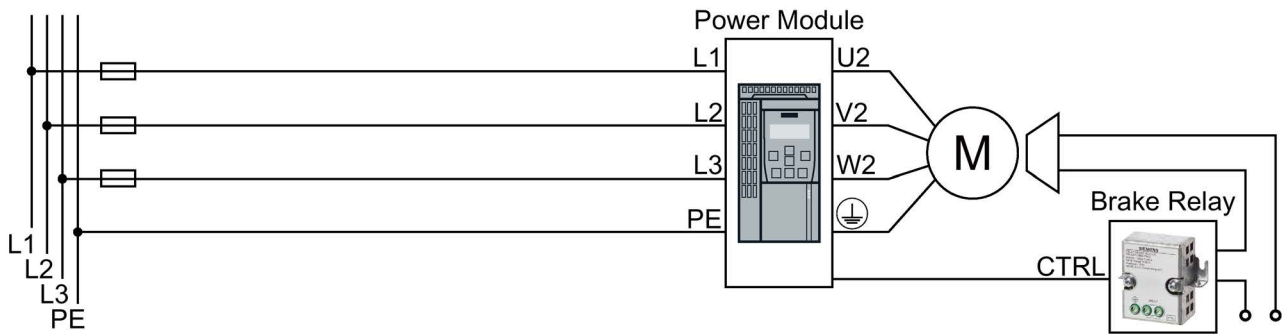

Image 4-8 Connecting the PM260 Power Module

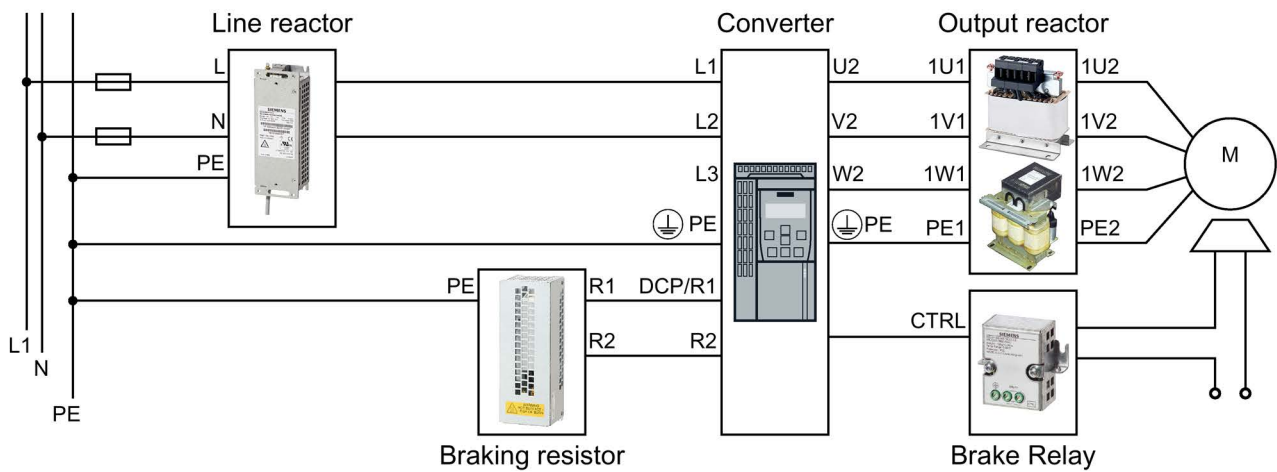

Image 4-9 Connecting the PM240-2 and PM340 1AC Power Modules



**⚠ DANGER**

**Danger to life as a result of a hazardous voltage at the motor connections**

As soon as the inverter is connected to the line supply, the motor connections of the inverter may carry dangerous voltages. When the motor is connected to the inverter, there is danger to life through contact with the motor terminals if the terminal box is open.

- Close the terminal box of the motor before connecting the inverter to the line supply.

**Connecting the line supply cable to the converter**

**Procedure**



To connect the converter to the supply system, proceed as follows:

1. If available, open the terminal covers of the converter.
2. Connect the line supply to terminals U1/L1, V1/L2, and W1/L3.
3. Connect the protective conductor of the line supply to terminal PE of the converter.
4. If available, close the terminal covers of the converter.





You have connected the line supply cable to the converter.

**Connecting the motor cable to the inverter**

**Procedure**



To connect the motor cable to the inverter, proceed as follows:

1. If available, open the terminal covers of the inverter.
2. Connect the motor at the U2, V2 and W2 terminals.  
 Connecting inverters in compliance with EMC (Page 54)
3. Connect the protective conductor of the motor to the  terminal of the inverter.
4. If available, close the terminal covers of the inverter.



You have now connected the motor line to the inverter.



## Connecting a motor cable to an induction motor

### Procedure



To connect the motor cable to an induction motor proceed as follows:

1. Open the motor terminal box.
2. Connect the motor in either a star or delta connection.
3. If you are using a shielded motor cable, you must do the following:
  - Expose the shield of the motor cable in the area of the cable entry in the terminal box.
  - Attach the cable shield to the motor terminal box using a suitable screw connection.
4. Close the motor terminal box.

■ You have connected the motor cable to the induction motor.

Depending on your application, you can operate the motor in the star or delta connection (Y/ $\Delta$ ).

### Examples for operating the converter and motor on a 400 V line supply

Assumption: The motor rating plate states 230/400 V  $\Delta$ /Y.

Case 1: A motor is normally operated between standstill and its rated speed (i.e. a speed corresponding to the line frequency). In this case, you need to connect the motor in Y. Operating the motor above its rated speed is only possible in field weakening, i.e. the motor torque available is reduced above the rated speed.

Case 2: If you want to operate the motor with the "87 Hz characteristic", you need to connect the motor in  $\Delta$ .

With the 87 Hz characteristic, the motor's power output increases. The 87 Hz characteristic is mainly used with geared motors.

Before you connect the motor, ensure that the motor has the appropriate connection for your application:

### Motor is connected in the star or delta configuration

With SIEMENS motors, you will see a diagram of both connection methods on the inside of the cover of the terminal box:

- Star connection (Y)
- Delta connection ( $\Delta$ )

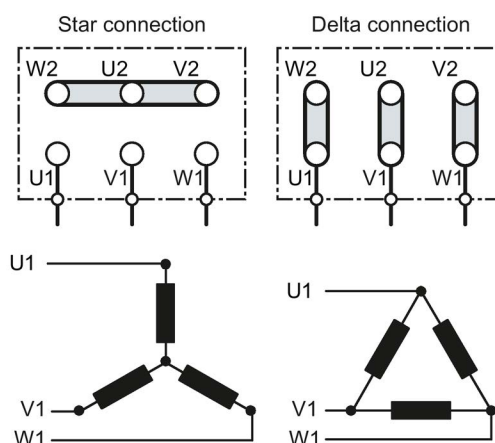

#### 4.5.4 Connecting a motor holding brake

The inverter uses the Brake Relay to control the motor holding brake. Two types of Brake Relay exist:

- The Brake Relay controls the motor holding brake
- The Safe Brake Relay controls a 24 V motor holding brake and monitors the brake control for short-circuit or cable breakage.

---

#### Note

##### Brake Relay and Safe Brake Relay

The Brake Relay and the Safe Brake Relay do not differ from each other in the installation and the connection to the inverter.

##### Connection to the inverter

To ensure that you have the correct cable for connecting the Brake Relay irrespective of the inverter size, you are supplied with two preassembled cables with different lengths. Connect the appropriate cable to the Brake Module and to the inverter as shown below.

If you are using your own cable, ensure that the cable is insulated and rated for 600 V.

---

### 4.5.4.1 Mounting and connecting the Brake Relay

The Brake Relay must be connected to the protective conductor if the motor brake is supplied from a PELV circuit.

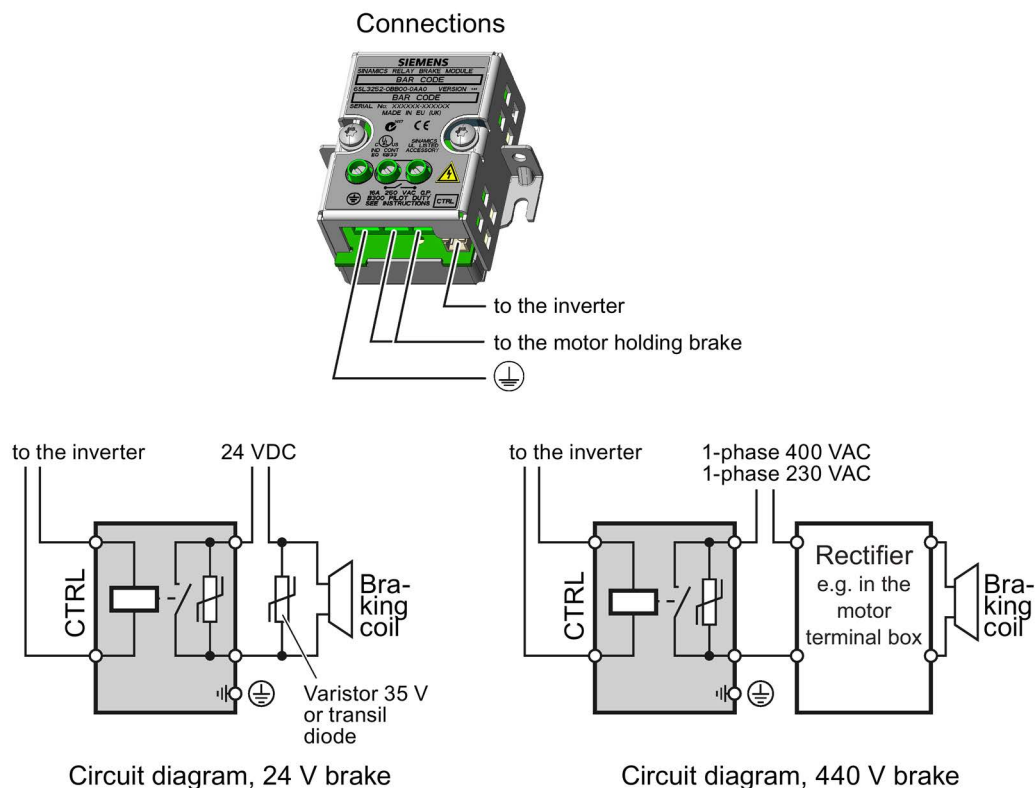

### 4.5.4.2 Mounting and connecting the Safe Brake Relay

The Safe Brake Relay must be connected to the protective conductor if the motor brake is supplied from a PELV circuit.

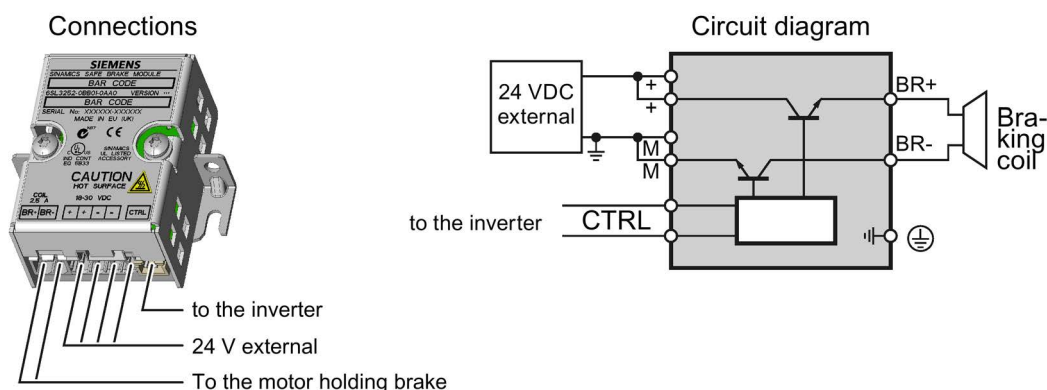

4.5.4.3 Technical data of the brake relay?

	Brake Relay 6SL32520BB000AA0	Safe Brake Relay 6SL32520BB010AA0
Input voltage	via the Power Module	20.4 ... 28.8 VDC <sup>1)</sup>
Input current	via the Power Module	Max. 2.5 A
Max. connection cross-section:	2.5 mm <sup>2</sup>	2.5 mm <sup>2</sup>
Degree of protection	IP20	IP20
Switching capability of the NO contact	1-phase 440 VAC, 3.5 A 1-phase 30 VDC, 12 A	-
Output voltage	-	24 V
Output current	-	max. 2 A

<sup>1)</sup> External, controlled power supply required. Recommended voltage: 26 VDC

4.5.4.4 Install and connect Brake Relay - PM240, PM250, PM260 Power Modules

Installing the Brake Relay

If you use the optional shield plate, install the Brake Relay on the shield plate of the Power Module.

If you do not use the shield plate, install the Brake Relay as close as possible to the Power Module.

Connecting the Brake Relay to the inverter

The connector for the Brake relay is located at the front of the Power Module for the FSA ... FSC frame sizes. These Power Modules have a cable entry for the connecting cable to the Brake Relay.

The connector for the Brake Relay is located at the bottom of the Power Module for the FSD ... FSF frame sizes.

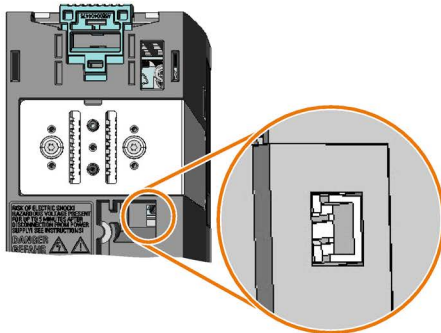

Brake relay connector for FSA ... FSC Power Modules

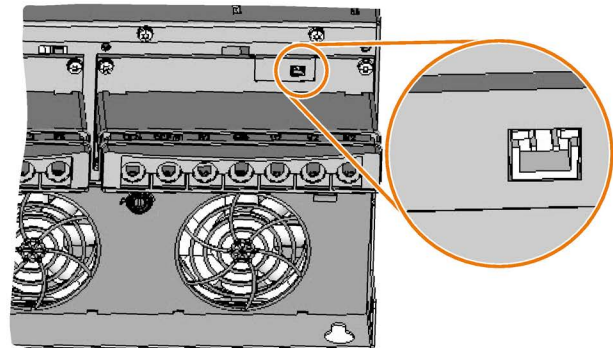

Brake relay connector for FSD ... FSF Power Modules

#### 4.5.4.5 Install and connect the Brake Relay - PM240-2 Power Module

##### Installing the Brake Relay

- **FSA ... FSC:** Install the Brake Relay next to the Power Module.
- **FSD ... FSF:** Install the Brake Relay at the rear of the lower shield plate. Attach the Brake Relay before you install the shield plate.

##### Connecting the Brake Relay to the inverter

The connector for the Brake Relay is located at the front of the Power Module. Lay the cable harness for the Brake Relay in the cable routing.

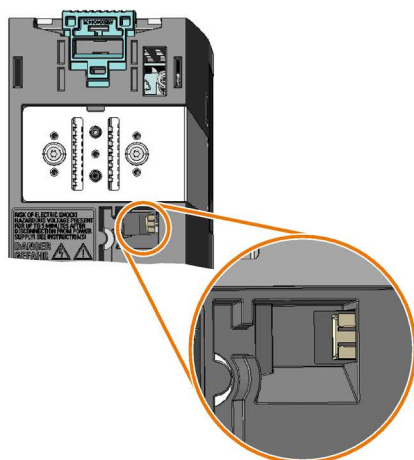

Brake relay connector for FSA ... FSC  
Power Modules without STO terminals

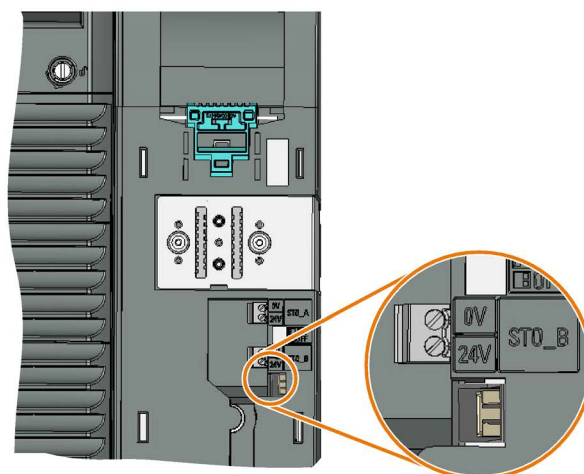

Brake relay connector for FSD ... FSF  
Power Modules with STO terminals

## 4.6 Installing Control Unit

### Installing the Control Unit - General

Each Power Module has an appropriate holder for the Control Unit and a release mechanism.

#### Inserting the Control Unit



Proceed as follows to plug the Control Unit onto a Power Module:

1. Place the two catches of the Control Unit in the matching grooves of the Power Module.
2. Press the Control Unit onto the Power Module until you hear that it latches.

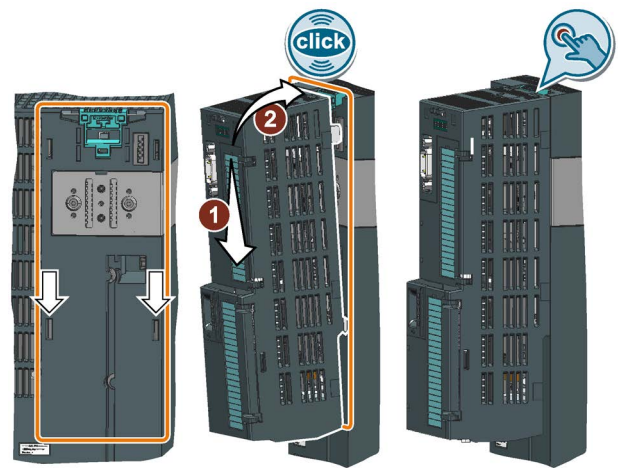

- You have now plugged the Control Unit onto the Power Module.

#### Removing the Control Unit

Remove the Control Unit from the Power Module by pressing the release mechanism.

### Special features for the PM240 FSGX Power Module

To insert or detach the Control Unit, you must release the two screws at the front cover, slightly shift the front cover upwards and remove towards the front.

Reattach the front cover before you commission the device.

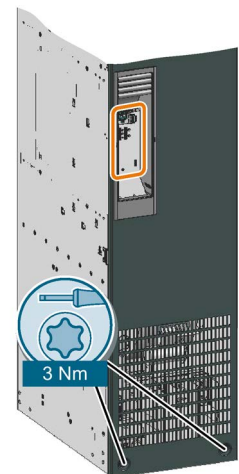

## 4.6.1 Overview of the interfaces

### Interfaces at the front of the Control Unit

To access the interfaces at the front of the Control Unit, you must lift the Operator Panel (if one is being used) and open the front doors.

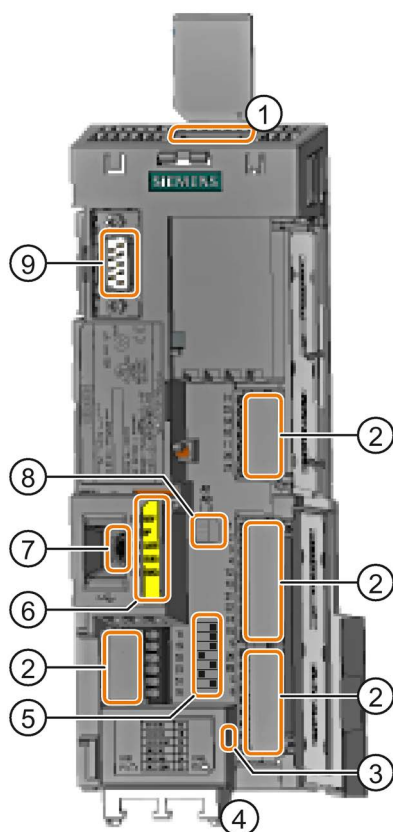

① Memory card slot

② Terminal strips

③ Depending on the fieldbus:

- USS, Modbus: Bus termination
- PROFIBUS, PROFINET, EtherNet/IP: No function

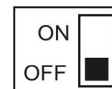

④ Fieldbus interfaces at the lower side

⑤ Selecting the fieldbus address

On all Control Units with the exception of CU240E-2 PN and CU240E-2 PN-F.

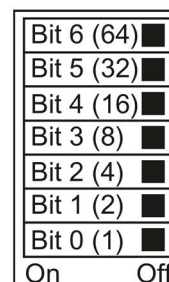

⑥ Status LED

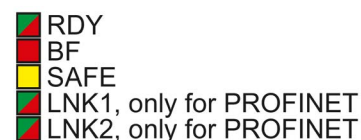

⑦ USB interface for connection to a PC

⑧ Switch for AI 0 and AI 1<sup>1)</sup> (U/I)

- I 0/4 mA ... 20 mA
- U -10/0 V ... 10 V

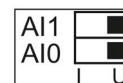

<sup>1)</sup> AI 1 is not available on the CU240B-2

⑨ Connection to the operator panel

Table 4- 13 Number of inputs and outputs

	Digital inputs DI	Digital outputs DO	Analog inputs AI	Analog outputs AO	Safe inputs F-DI <sup>1)</sup>
CU240B-2, CU240B-2 DP	4	1	1	1	0
CU240E-2, CU240E-2 DP, CU240E-2 PN	6	3	2	2	1
CU240E-2 F, CU240E-2 DP-F, CU240E-2 PN-F	6	3	2	2	3

<sup>1)</sup> Every F-DI safe input used occupies two digital inputs DI

### 4.6.2 Fieldbus interface allocation

#### Interfaces at the lower side of the CU240B-2 and CU240E-2 Control Units

RS485 plug for  
USS and Modbus RTU (X128)

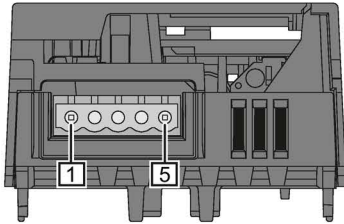

- Pin
- 1 0 V, reference potential
  - 2 RS485P, receive and transmit (+)
  - 3 RS485N, receive and transmit (-)
  - 4 Cable shield
  - 5 Not connected

RJ45 connector socket for PROFINET  
IO (X150 P1, X150 P2)

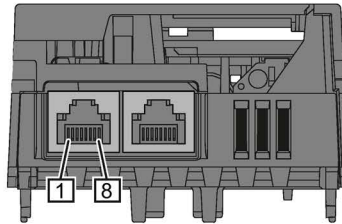

- Pin
- 1 RX+, receive data +
  - 2 RX-, receive data -
  - 3 TX+, Transmit data +
  - 4 Not assigned
  - 5 Not assigned
  - 6 TX-, transmit data -
  - 7 Not assigned
  - 8 Not assigned

SUB-D socket for PROFIBUS DP  
(X126)

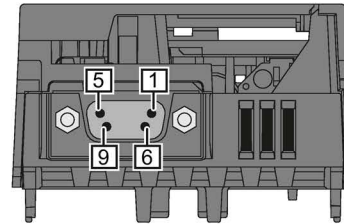

- Pin
- 1 Shield, grounding connection
  - 2 Not assigned
  - 3 RxD/TxD-P, receive and transmit (B/B')
  - 4 CNTR-P, control signal
  - 5 DGND, reference potential for data (C/C')
  - 6 VP, supply voltage
  - 7 Not assigned
  - 8 RxD/TxD-N, receive and transmit (A/A')
  - 9 Not assigned



### 4.6.3 Terminal strips on CU240B-2 Control Units

#### Terminal strips with wiring example

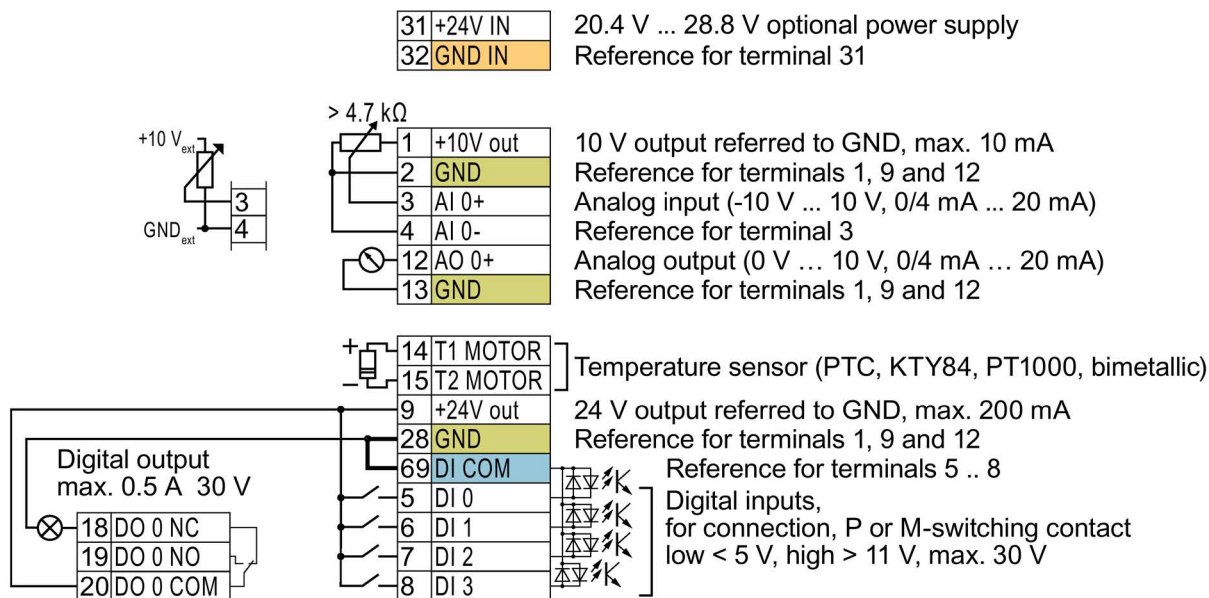

**GND**

All terminals labelled with reference potential "GND" are connected internally in the inverter.

**DI COM**

Reference potential "DI COM" is electrically isolated from "GND".

→ If, as shown above, the 24 V supply from terminal 9 is used to supply the digital inputs, then you must connect "GND" to "DI COM".

Terminals 31, 32

When an optional 24-V power supply is connected to terminals 31, 32, the Control Unit remains in operation even after the Power Module has been disconnected from the line supply. The Control Unit thus maintains the fieldbus communication, for example.

**GND IN**

→ At terminals 31, 32, only connect a power supply that is in accordance with SELV (Safety Extra Low Voltage) or PELV (Protective Extra Low Voltage).

→ If you also wish to use the power supply at terminals 31, 32 for the digital inputs, then you must connect "DI COM" and "GND IN" with one another.

Terminals 3, 4:

You may use the internal 10V power supply or an external power supply for the analog input.

→ If you use the internal 10 V power supply, you must connect AI 0- to GND.

Image 4-10 Wiring example of the digital inputs with the internal inverter 24 V power supply

Additional options for wiring the digital inputs

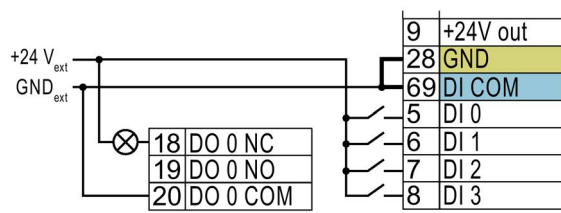

You must remove the jumper between terminals 28 and 69 if it is necessary to have electrical isolation between the external power supply and the internal inverter power supply.

Connecting P-switching contacts with an external power supply

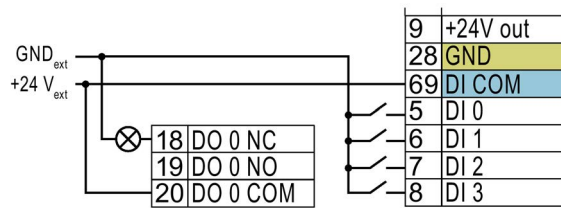

It is not permissible that terminals 28 and 69 are connected with one another.

Connecting M-switching contacts with an external power supply

### 4.6.3.1 Factory setting of the CU240B-2 interfaces

#### Factory setting of the terminal strip on the CU240B-2

The factory setting of the terminals depends on whether the Control Unit has a PROFIBUS / PROFINET interface.

#### Control Units with USS interface

The fieldbus interface is not active.

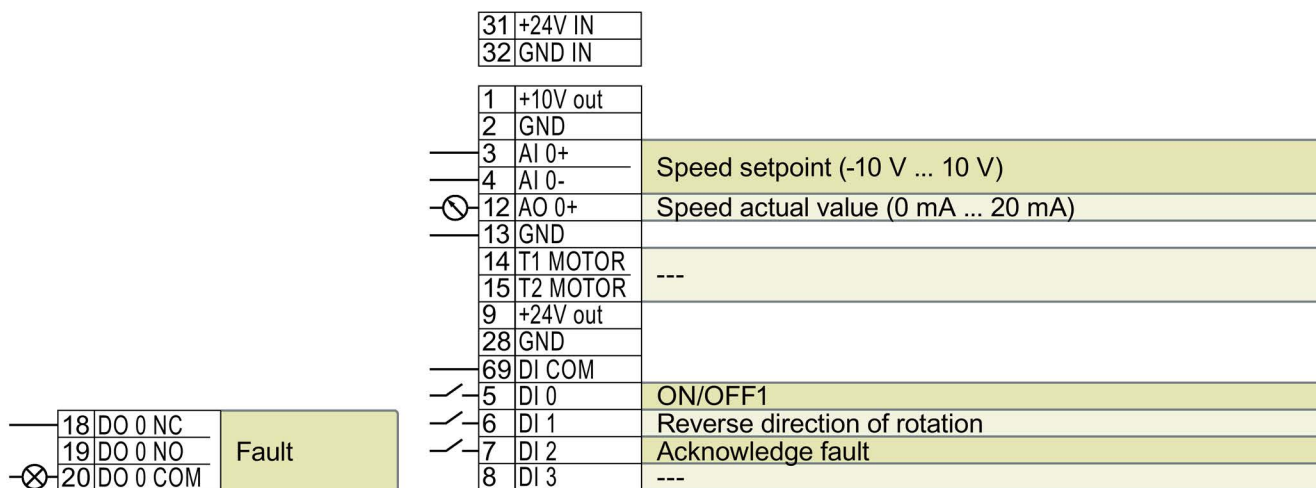

--- No function.

DO 0: p0730

AO 0: p0771[0]

DI x: r0722.x

AI 0: r0755[0]

Speed setpoint (main setpoint): p1070[0] = 755[0]

Image 4-11 Factory settings of the CU240B-2 Control Unit

**Control Units with PROFIBUS interface**

The function of the fieldbus interface and digital inputs DI 0, DI 1 depends on DI 3.

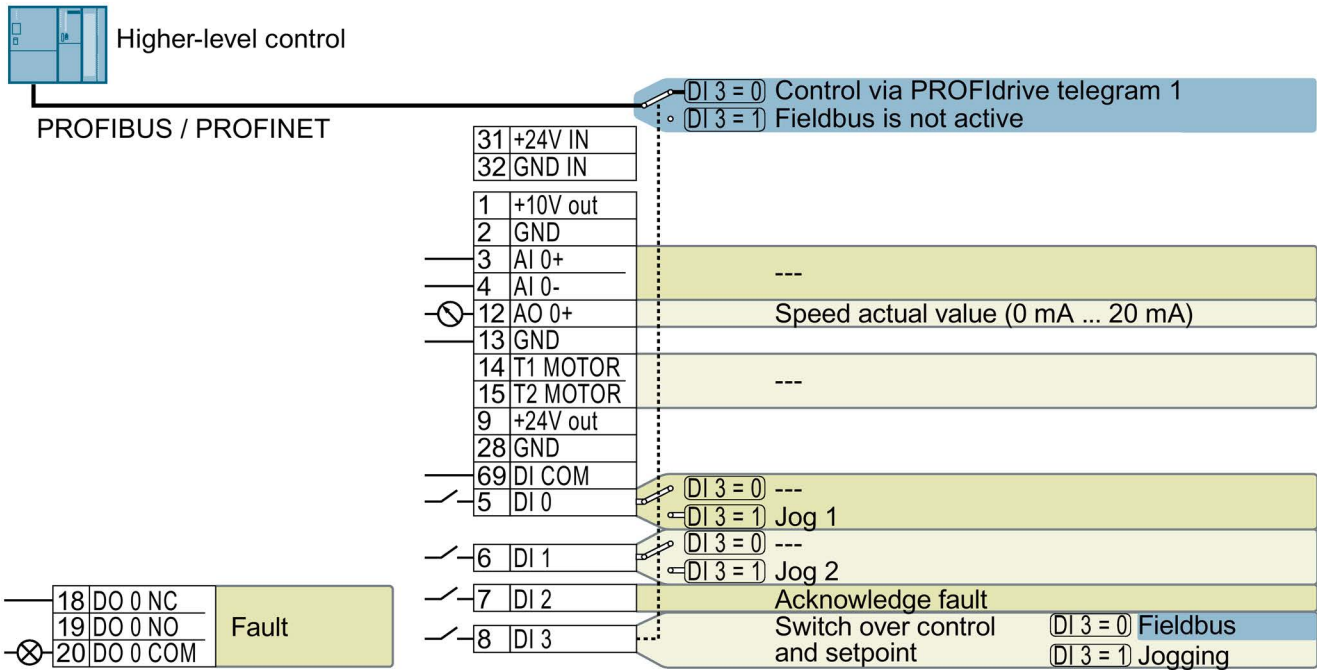

--- No function.

DO 0: p0730

AO 0: p0771[0]

DI x: r0722.x

Speed setpoint (main setpoint): p1070[0] = 2050[1]

Image 4-12 Factory setting of the CU240B-2 DP and CU240B-2 PN Control Units

**Changing the function of the terminals**

The function of the terminals marked in color in the two diagrams above, can be set.

In order not to have to successively change terminal for terminal, several terminals can be jointly set using default settings ("p0015 Macro drive unit").

The terminal settings made in the factory described above correspond to the following default settings:

- Default setting 12 (p0015 = 12): "Standard I/O with analog setpoint"
- Default setting 7 (p0015 = 7): "Fieldbus with data set switchover"

### 4.6.3.2 Default settings of the CU240B-2 interfaces

#### Default setting 7: "Fieldbus with data set switchover"

Factory setting for inverters with PROFIBUS interface

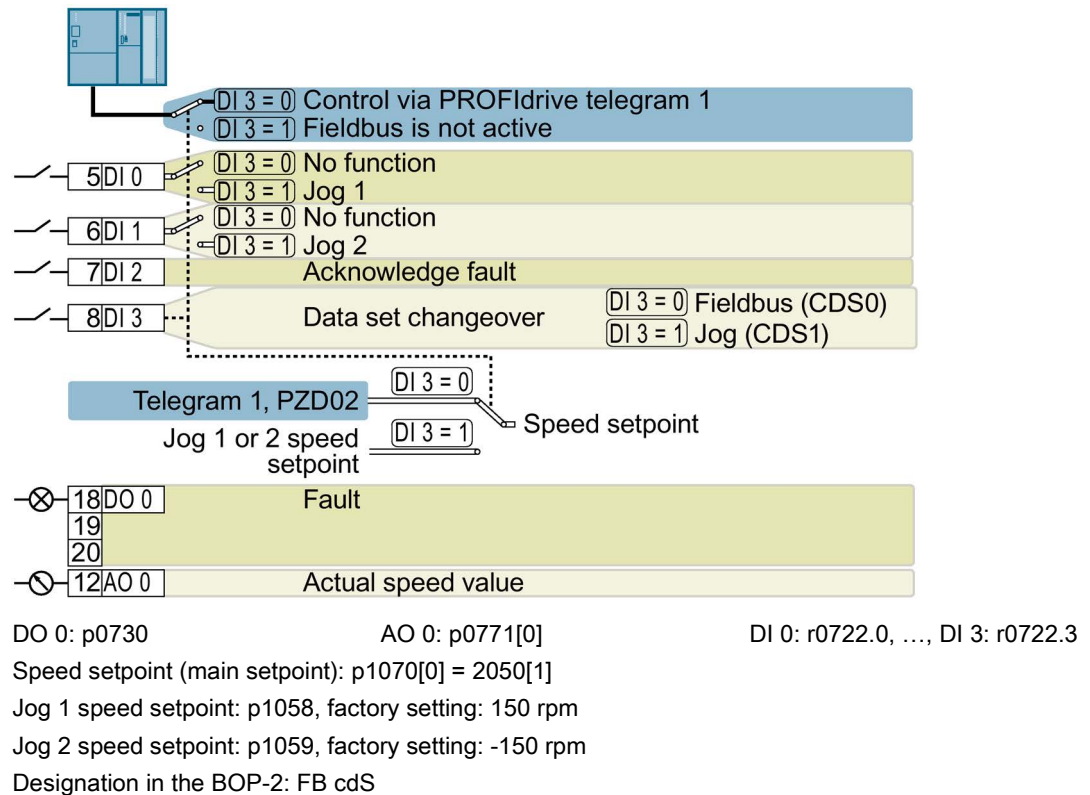

#### Default setting 9: "Standard I/O with MOP"

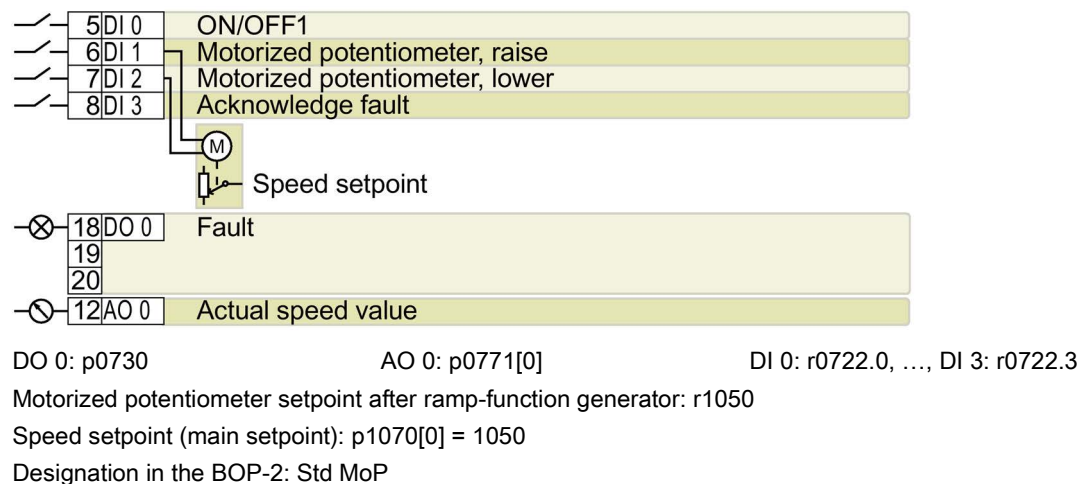

**Default setting 12: "Standard I/O with analog setpoint"**

Factory setting for inverters with USS interface

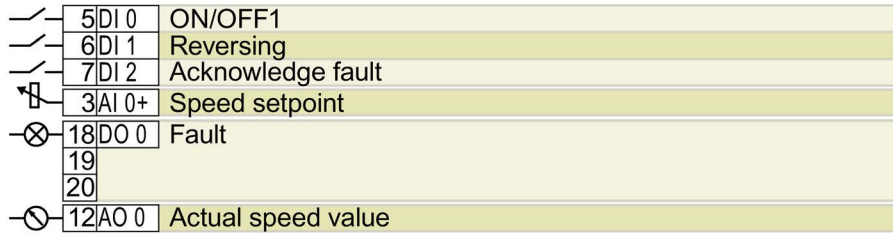

DO 0: p0730                      AO 0: p0771[0]                      DI 0: r0722.0, ..., DI 2: r0722.2                      AI 0: r0755[0]  
 Speed setpoint (main setpoint): p1070[0] = 755[0]  
 Designation in the BOP-2: Std ASP

**Default setting 17: "2-wire (forw/backw1)"**

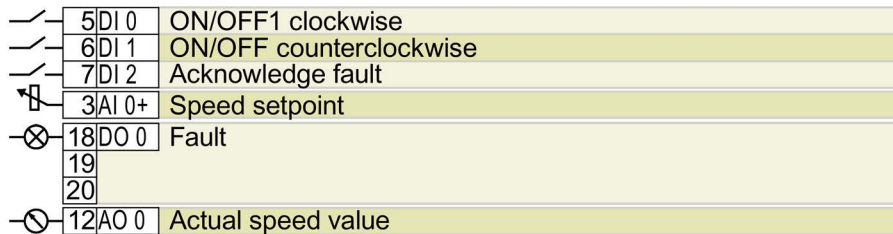

DO 0: p0730                      AO 0: p0771[0]                      DI 0: r0722.2, ..., DI 2: r0722.2                      AI 0: r0755[0]  
 Speed setpoint (main setpoint): p1070[0] = 755[0]  
 Designation in the BOP-2: 2-wlrE 1

**Default setting 18: "2-wire (forw/backw2)"**

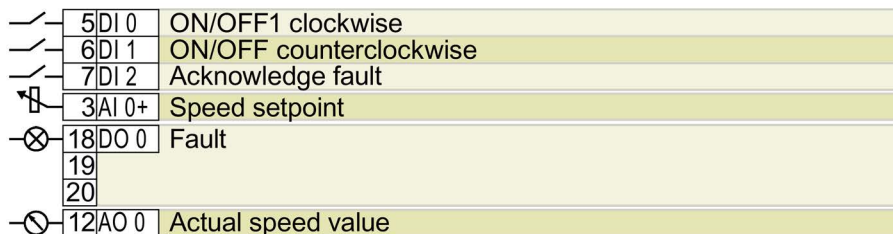

DO 0: p0730                      AO 0: p0771[0]                      DI 0: r0722.2, ..., DI 2: r0722.2                      AI 0: r0755[0]  
 Speed setpoint (main setpoint): p1070[0] = 755[0]  
 Designation in the BOP-2: 2-wlrE 2

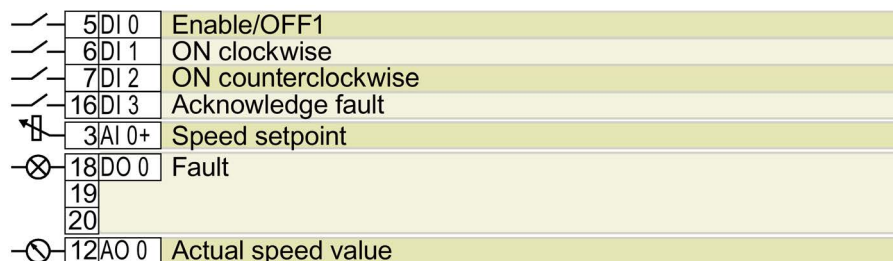
**Default setting 19: "3-wire (enable/forw/backw)"**

DO 0: p0730                      AO 0: p0771[0]                      DI 0: r0722.0, ..., DI 3: r0722.3                      AI 0: r0755[0]  
 Speed setpoint (main setpoint): p1070[0] = 755[0]  
 Designation in the BOP-2: 3-wlrE 1

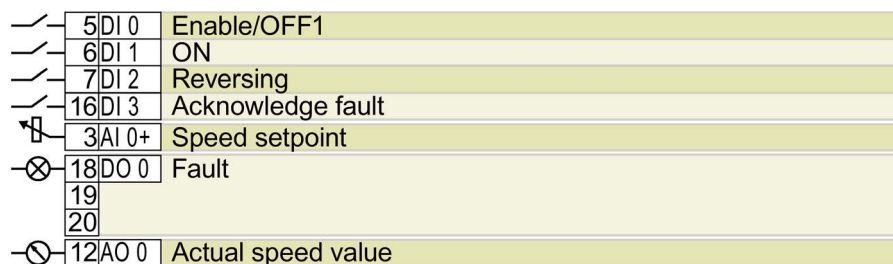
**Default setting 20: "3-wire (enable/on/reverse)"**

DO 0: p0730                      AO 0: p0771[0]                      DI 0: r0722.0, ..., DI 3: r0722.3                      AI 0: r0755[0]  
 Speed setpoint (main setpoint): p1070[0] = 755[0]  
 Designation in the BOP-2: 3-wlrE 2

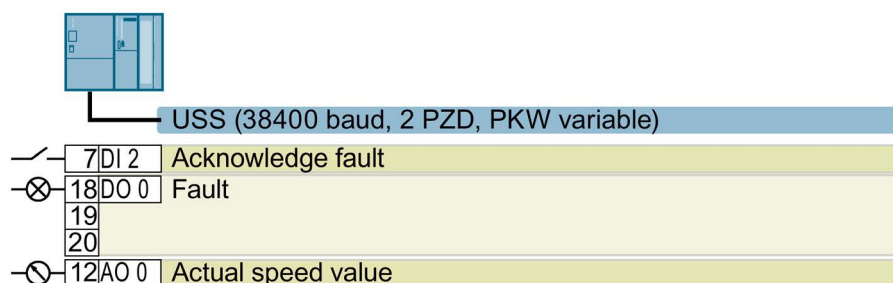
**Default setting 21: "USS fieldbus"**

DO 0: p0730                      AO 0: p0771[0]                      DI 2: r0722.2  
 Speed setpoint (main setpoint): p1070[0] = 2050[1]  
 Designation in the BOP-2: FB USS



### 4.6.4 Terminal strips on CU240E-2 Control Units

#### Terminal strips with wiring example

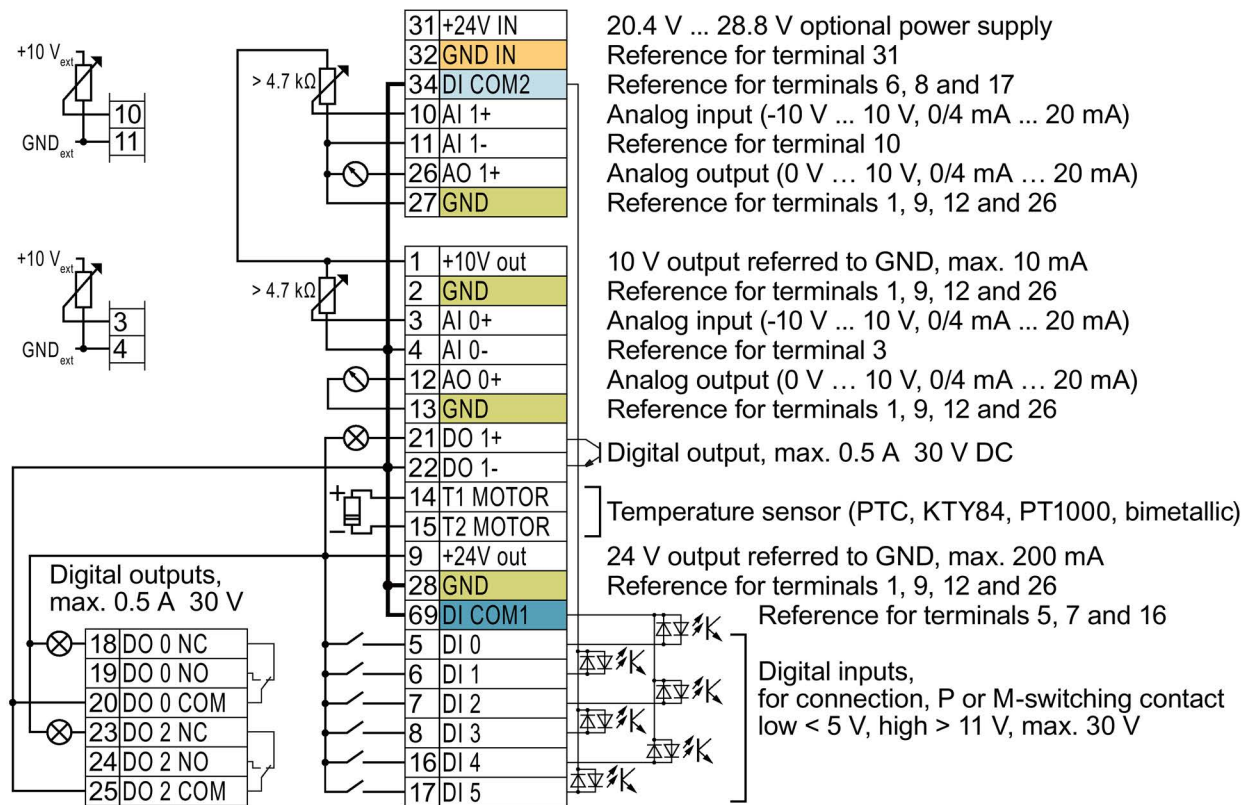

- GND** All terminals labelled with reference potential "GND" are connected internally in the inverter.
- DI COM1** Reference potentials "DI COM1" and "DI COM2" are electrically isolated from "GND".
- DI COM2** → If, as shown above, the 24 V supply from terminal 9 is used to supply the digital inputs, then you must connect "GND", "DI COM1" and "DI COM2" with one another.
- Terminals 31, 32** When an optional 24-V power supply is connected to terminals 31, 32, the Control Unit remains in operation even after the Power Module has been disconnected from the line supply. The Control Unit thus maintains the fieldbus communication, for example.
  - At terminals 31, 32, only connect a power supply that is in accordance with SELV (Safety Extra Low Voltage) or PELV (Protective Extra Low Voltage).
  - If you also wish to use the power supply at terminals 31, 32 for the digital inputs, then you must connect "DI COM1/2" and "GND IN" with one another.
- GND IN**
- Terminals 3, 4 and 10, 11:** You may use the internal 10V power supply or an external power supply for the analog inputs.
  - If you use the internal 10 V power supply, you must connect AI 0- or AI 1- to GND.

Image 4-13 Wiring example of the digital inputs with the internal inverter 24 V power supply



### Additional options for wiring the digital inputs

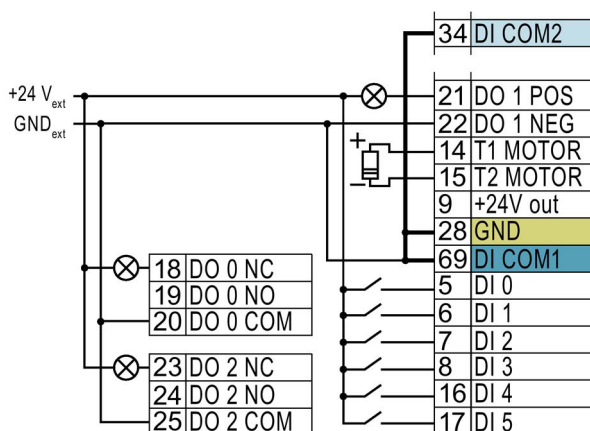

If you wish to connect the potential of an external power supply with the potential of the internal inverter power supply, then you must connect "GND" with terminals 34 and 69.

Connecting P-switching contacts with an external power supply

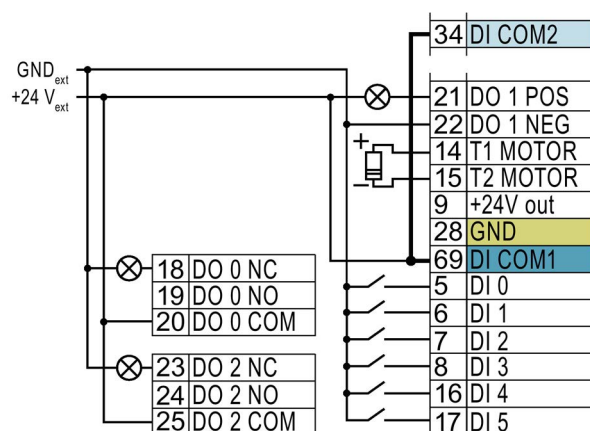

Connect terminals 69 and 34 with one another.

Connecting M-switching contacts with an external power supply

#### NOTICE

##### Damage to the CU240E-2 PN and CU240E-2 PN-F Control Units in the event of a short-circuit of the 24 V output

It is possible that the Control Units are defective if the following conditions occur simultaneously:

1. A short-circuit at the 24 V output occurs at terminal 9 when the inverter is operational.
2. The ambient temperature is at the upper permitted limit.
3. You have connected an external 24 V supply to terminals 31 and 32, and the voltage at terminal 31 is at the upper permitted limit.

In order to rule out damage to the Control Units, you have to prevent all three conditions occurring simultaneously.

4.6.4.1 Factory setting of the CU240E-2 interfaces

Factory setting of the terminal strip on the CU240E-2

The factory setting of the terminal strip depends on the Control Unit.

Control Units with USS interface

The fieldbus interface is not active.

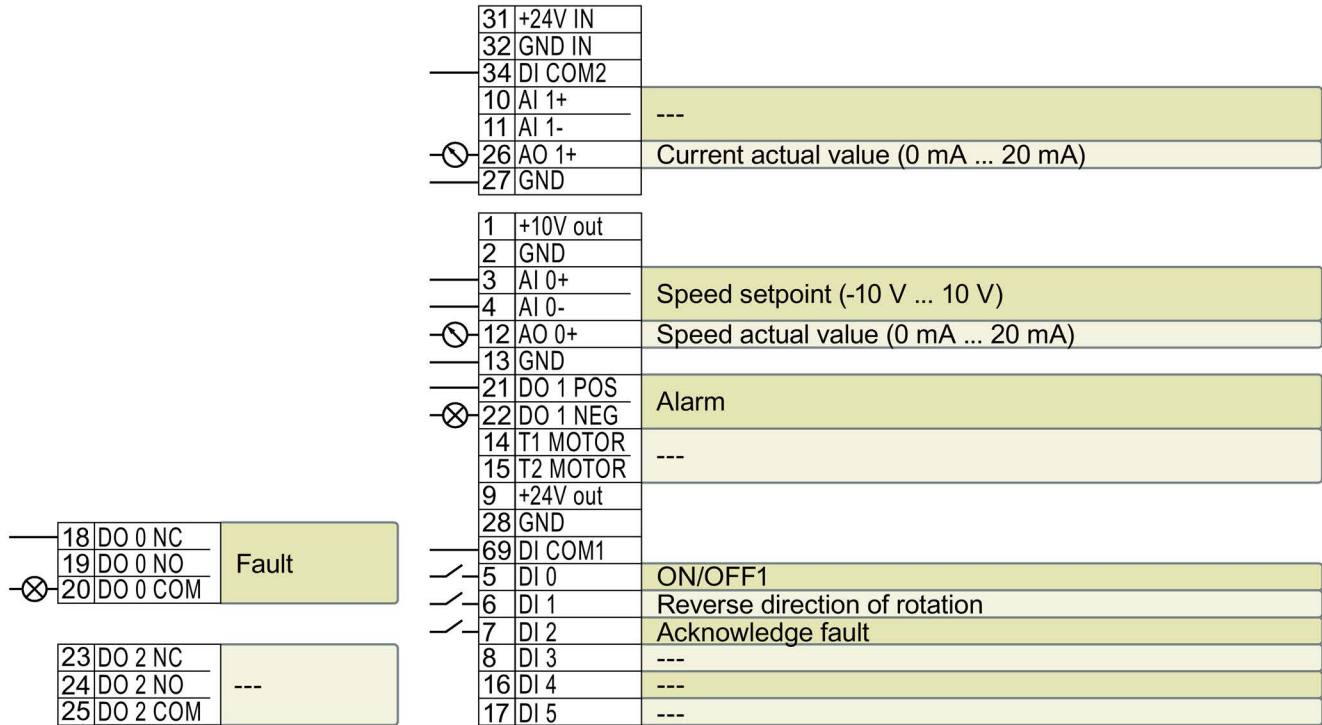

--- No function.

DO x: p073x

AO 0: p0771[0]

DI x: r0722.x

AI 0: r0755[0]

Speed setpoint (main setpoint): p1070[0] = 755[0]

Image 4-14 Factory setting of the CU240E-2 and CU240E-2 F Control Units

### Control Units with PROFIBUS or PROFINET interface

The function of the fieldbus interface and digital inputs DI 0, DI 1 depends on DI 3.

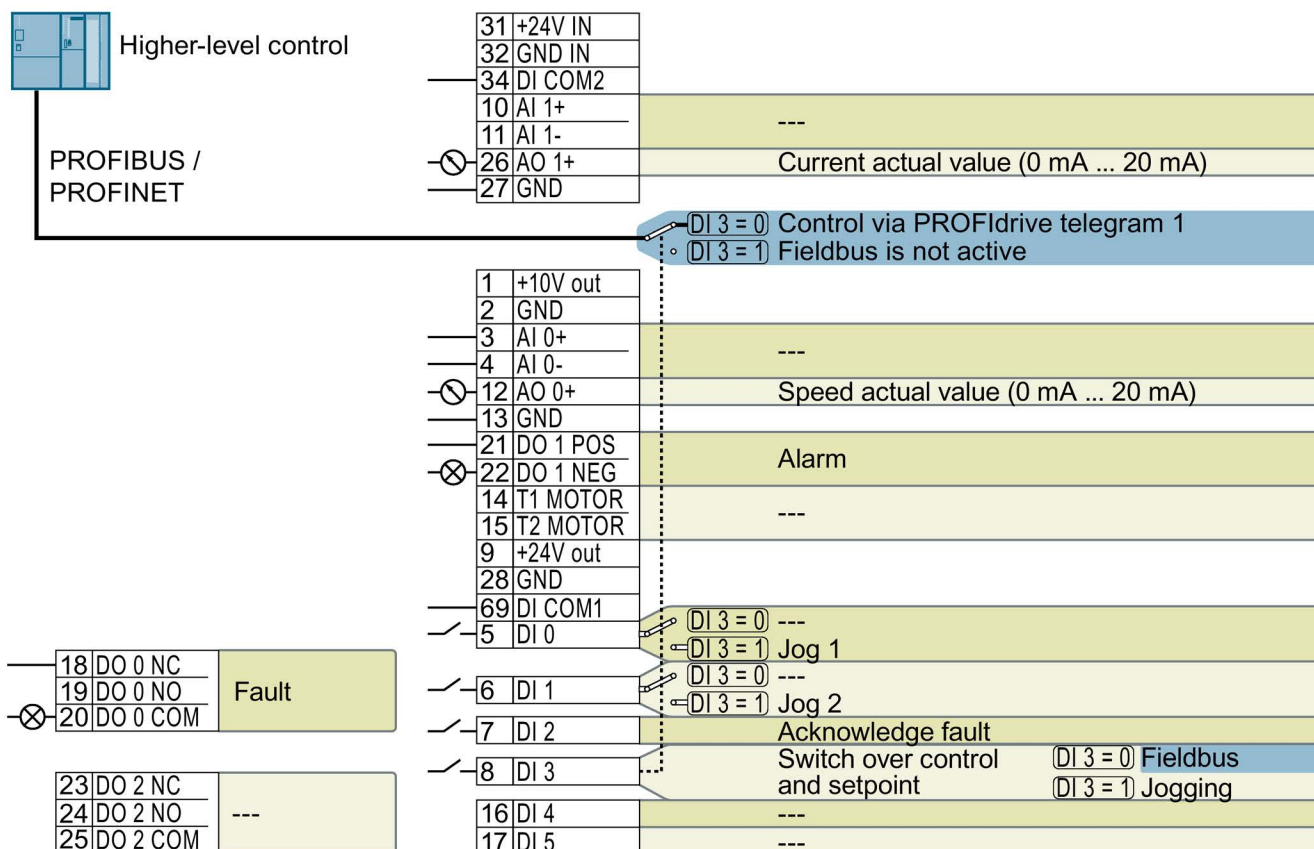

--- No function.

DO x: p073x

AO 0: p0771[0]

DI x: r0722.x

Speed setpoint (main setpoint): p1070[0] = 2050[1]

Image 4-15 Factory setting of the CU240E-2 DP(-F) and CU240E-2 PN(-F) Control Units

### Changing the function of the terminals

The function of the terminals marked in color in the two diagrams above, can be set.

In order not to have to successively change terminal for terminal, several terminals can be jointly set using default settings ("p0015 Macro drive unit").

The terminal settings made in the factory described above correspond to the following default settings:

- Default setting 12 (p0015 = 12): "Standard I/O with analog setpoint"
- Default setting 7 (p0015 = 7): "Fieldbus with data set switchover"

4.6.4.2 Default settings of the CU240E-2 interfaces

Default setting 1: "Conveyor technology with 2 fixed frequencies"

—	5	DI 0	ON/OFF1 clockwise
—	6	DI 1	ON/OFF1 counterclockwise
—	7	DI 2	Acknowledge fault
—	16	DI 4	Fixed speed setpoint 3:
—	17	DI 5	Fixed speed setpoint 4
⊗	18	DO 0	Fault
	19		
	20		
⊗	21	DO 1	Warning
	22		
⊗	12	AO 0	Actual speed value
⊗	26	AO 1	Actual current value

DO 0: p0730, DO 1: p0731      AO 0: p0771[0], AO 1: p0771[1]    DI 0: r0722.0, ..., DI 5: r0722.5  
 Fixed speed setpoint 3: p1003, fixed speed setpoint 4: p1004, fixed speed setpoint active: r1024  
 Speed setpoint (main setpoint): p1070[0] = 1024  
 DI 4 and DI 5 = high: The inverter adds both fixed speed setpoints  
 Designation in the BOP-2: coN 2 SP

Default setting 2: "Conveyor systems with Basic Safety"

—	5	DI 0	ON/OFF1 with fixed speed setpoint 1
—	6	DI 1	Fixed speed setpoint 2:
—	7	DI 2	Acknowledge fault
—	16	DI 4	} Reserved für a safety function
—	17	DI 5	
⊗	18	DO 0	Fault
	19		
	20		
⊗	21	DO 1	Warning
	22		
⊗	12	AO 0	Actual speed value
⊗	26	AO 1	Actual current value

DO 0: p0730, DO 1: p0731      AO 0: p0771[0], AO 1: p0771[1]    DI 0: r0722.0, ..., DI 5: r0722.5  
 Fixed speed setpoint 1: p1001, fixed speed setpoint 2: p1002, fixed speed setpoint active: r1024  
 Speed setpoint (main setpoint): p1070[0] = 1024  
 DI 0 and DI 1 = high: The inverter adds both fixed speed setpoints.  
 Designation in the BOP-2: coN SAFE

### Default setting 3: "Conveyor technology with 4 fixed frequencies"

—	5	DI 0	ON/OFF1 with fixed speed setpoint 1
—	6	DI 1	Fixed speed setpoint 2:
—	7	DI 2	Acknowledge fault
—	16	DI 4	Fixed speed setpoint 3:
—	17	DI 5	Fixed speed setpoint 4
⊗	18	DO 0	Fault
	19		
	20		
⊗	21	DO 1	Warning
	22		
⊗	12	AO 0	Actual speed value
⊗	26	AO 1	Actual current value

DO 0: p0730, DO 1: p0731      AO 0: p0771[0], AO 1: p0771[1]    DI 0: r0722.0, ..., DI 5: r0722.5

Fixed speed setpoint 1: p1001, ... fixed speed setpoint 4: p1004, fixed speed setpoint active: r1024

Speed setpoint (main setpoint): p1070[0] = 1024

Several DI 0, DI 1, DI 4 and DI 5 = high: The inverter adds the corresponding fixed speed setpoints.

Designation in the BOP-2: coN 4 SP

### Default setting 4: "Conveyor systems with fieldbus"

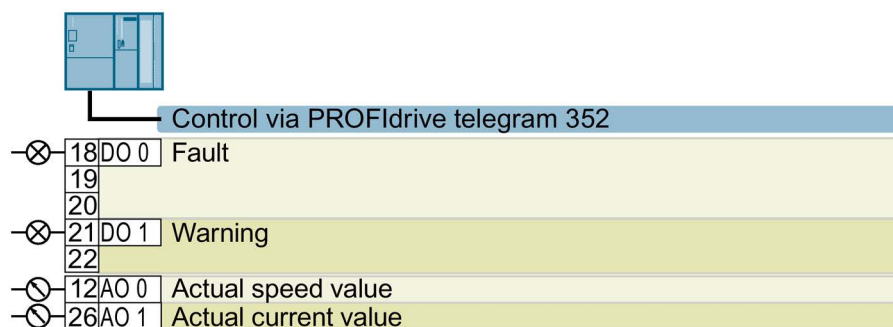

DO 0: p0730, DO 1: p0731

AO 0: p0771[0], AO 1: p0771[1]

Speed setpoint (main setpoint): p1070[0] = 2050[1]

Designation in the BOP-2: coN Fb

**Default setting 5: "Conveyor systems with fieldbus and Basic Safety"**

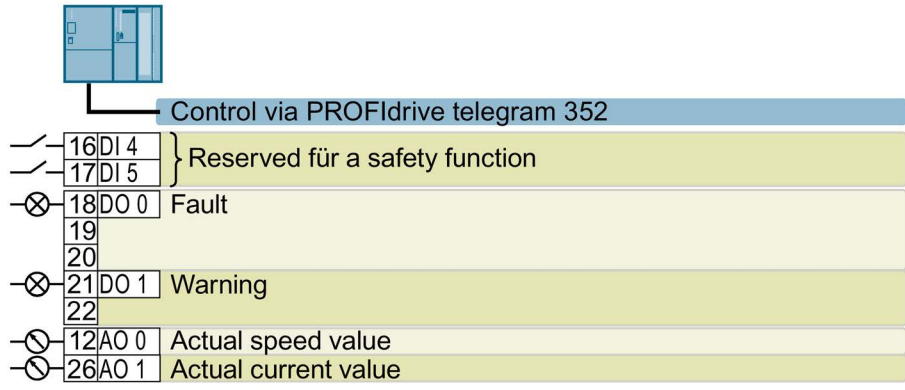

DO 0: p0730, DO 1: p0731      AO 0: p0771[0], AO 1: p0771[1]    DI 4: r0722.4, DI 5: r0722.5  
 Speed setpoint (main setpoint): p1070[0] = 2050[1]  
 Designation in the BOP-2: coN Fb S

**Default setting 6: "Fieldbus with Extended Safety"**

Only with Control Units CU240E-2 F, CU240E-2 DP-F, and CU240E-2 PN-F.

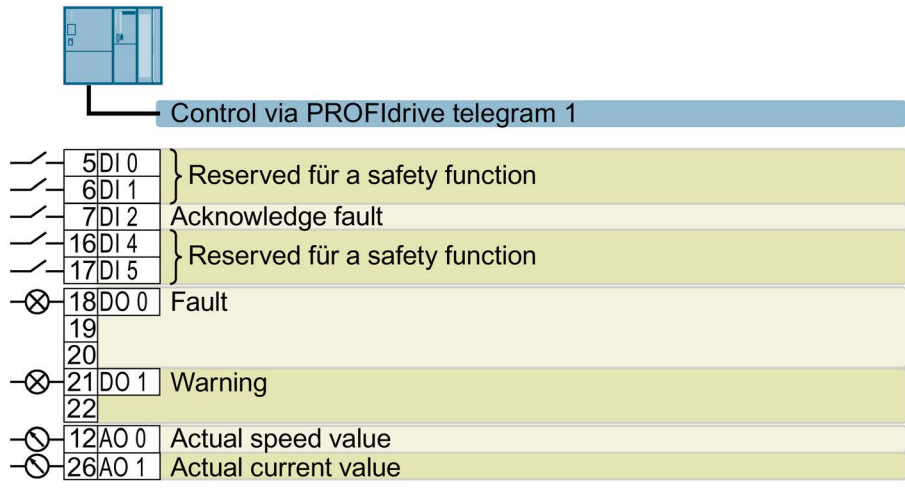

DO 0: p0730, DO 1: p0731      AO 0: p0771[0], AO 1: p0771[1]    DI 0: r0722.0, ..., DI 5: r0722.5  
 Speed setpoint (main setpoint): p1070[0] = 2050[1]  
 Designation in the BOP-2: Fb SAFE

## Default setting 7: "Fieldbus with data set switchover"

Factory setting for inverters with PROFIBUS or PROFINET interface

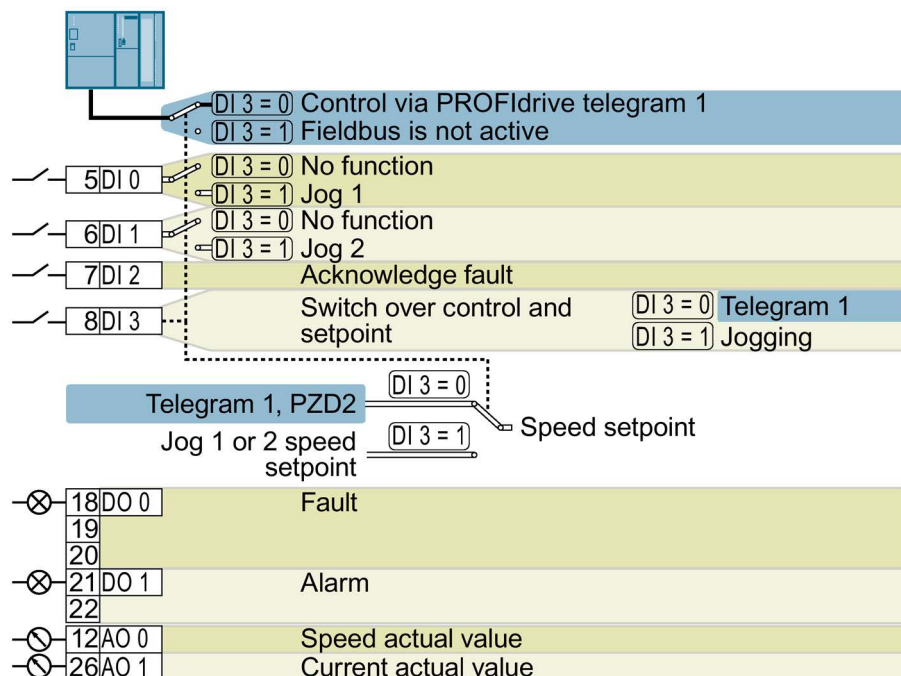

DO 0: p0730, DO 1: p0731      AO 0: p0771[0], AO 1: p0771[1]      DI 0: r0722.0, ..., DI 3: r0722.3

Speed setpoint (main setpoint): p1070[0] = 2050[1]

Jog 1 speed setpoint: p1058, factory setting: 150 rpm

Jog 2 speed setpoint: p1059, factory setting: -150 rpm

Designation in the BOP-2: FB cdS

**Default setting 8: "MOP with Basic Safety"**

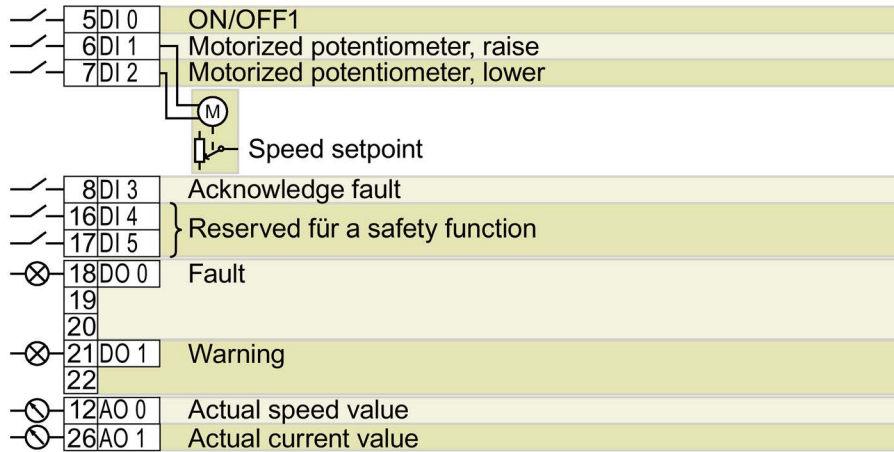

DO 0: p0730, DO 1: p0731      AO 0: p0771[0], AO 1: p0771[1]    DI 0: r0722.0, ..., DI 5: r0722.5  
 Motorized potentiometer setpoint after ramp-function generator: r1050  
 Speed setpoint (main setpoint): p1070[0] = 1050  
 Designation in the BOP-2: MoP SAFE

**Default setting 9: "Standard I/O with MOP"**

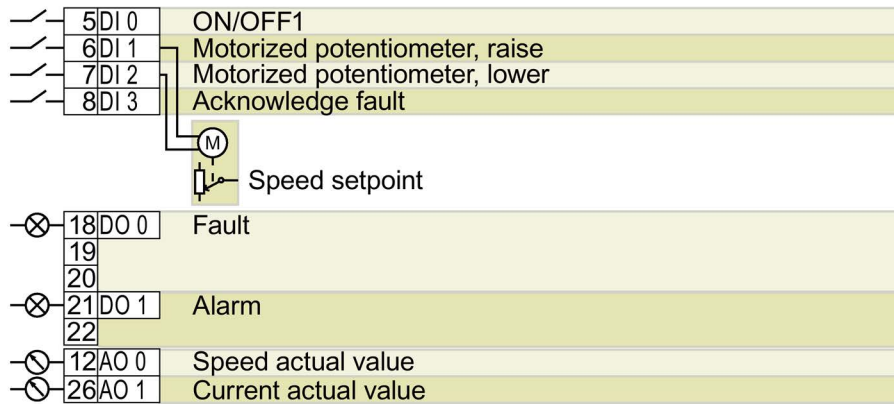

DO 0: p0730, DO 1: p0731      AO 0: p0771[0], AO 1: p0771[1]    DI 0: r0722.0, ..., DI 3: r0722.3  
 Motorized potentiometer setpoint after ramp-function generator: r1050  
 Speed setpoint (main setpoint): p1070[0] = 1050  
 Designation in the BOP-2: Std MoP



**Default setting 12: "Standard I/O with analog setpoint"**

5	DI 0	ON/OFF1
6	DI 1	Reversing
7	DI 2	Acknowledge fault
3	AI 0+	Speed setpoint
18	DO 0	Fault
19		
20		
21	DO 1	Alarm
22		
12	AO 0	Speed actual value
26	AO 1	Current actual value

DO 0: p0730,      AO 0: p0771[0], AO 1: p0771[1]    DI 0: r0722.0, ..., DI 2: r0722.2    AI 0: r0755[0]  
 DO 1: p0731

Speed setpoint (main setpoint): p1070[0] = 755[0]

Designation in the BOP-2: Std ASP

**Default setting 13: "Standard I/O with analog setpoint and safety"**

5	DI 0	ON/OFF1
6	DI 1	Reversing
7	DI 2	Acknowledge fault
16	DI 4	} Reserved für a safety function
17	DI 5	
3	AI 0+	Speed setpoint
18	DO 0	Fault
19		
20		
21	DO 1	Warning
22		
12	AO 0	Actual speed value
26	AO 1	Actual current value

DO 0: p0730,      AO 0: p0771[0], AO 1: p0771[1]    DI 0: r0722.0, ..., DI 5: r0722.5    AI 0: r0755[0]  
 DO 1: p0731

Speed setpoint (main setpoint): p1070[0] = 755[0]

Designation in the BOP-2: ASPS

**Default setting 14: "Process industry with fieldbus"**

PROFdrive telegram 20

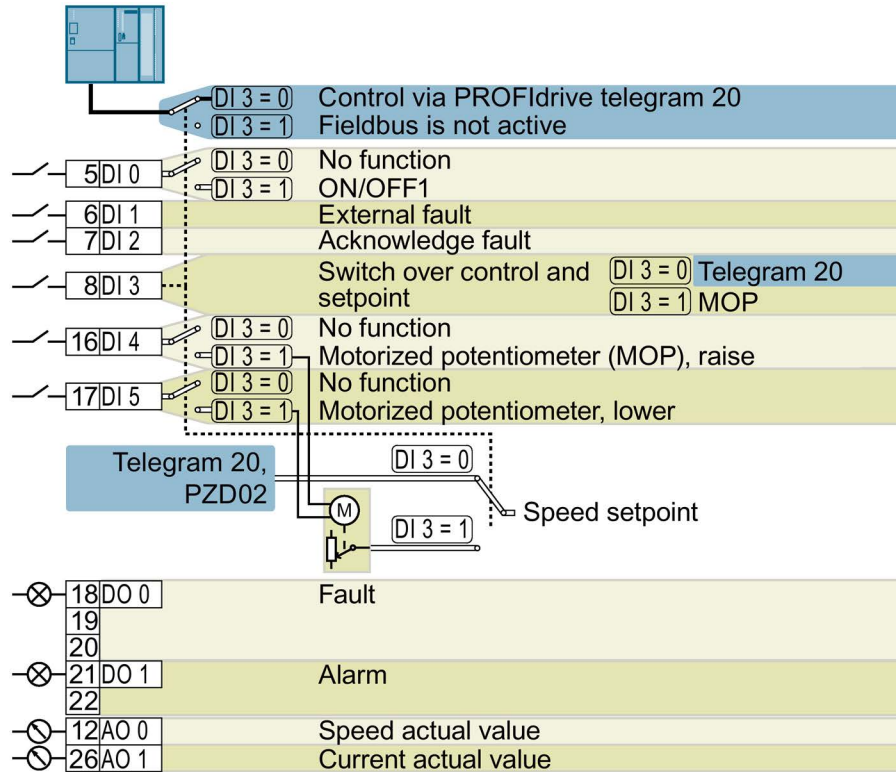

MOP = motorized potentiometer

DO 0: p0730, DO 1: p0731      AO 0: p0771[0], AO 1: p0771[1]      DI 0: r0722.0, ..., DI 5: r0722.5

Motorized potentiometer setpoint after ramp-function generator: r1050

Speed setpoint (main setpoint): p1070[0] = 2050[1], p1070[1] = 1050

Designation in the BOP-2: Proc Fb

### Default setting 15: "Process industry"

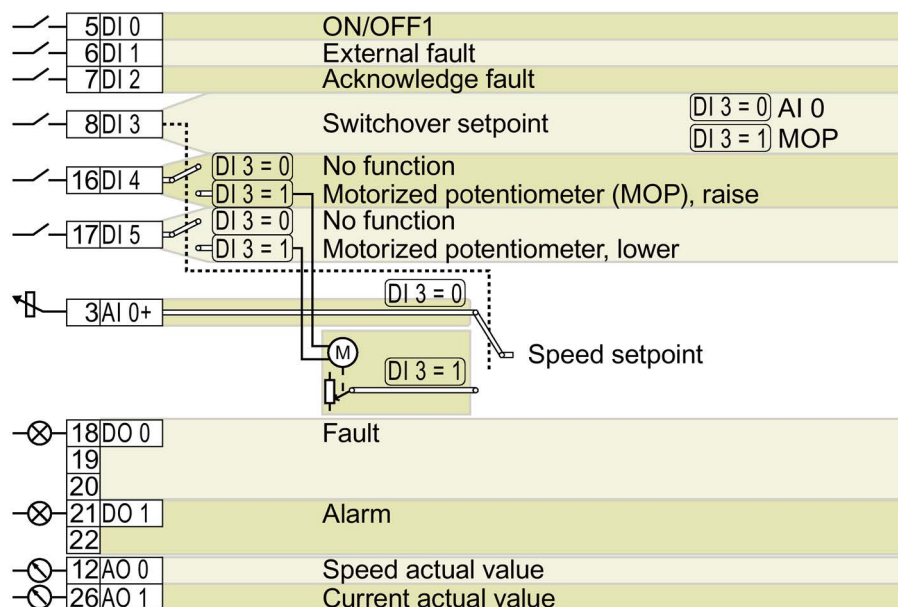

DO 0: p0730,      AO 0: p0771[0], AO 1: p0771[1]    DI 0: r0722.5, ..., DI 4: r0722.5    AI 0: r0755[0]  
DO 1: p0731

Motorized potentiometer setpoint after ramp-function generator: r1050

Speed setpoint (main setpoint): p1070[0] = 755[0], p1070[1] = 1050

Designation in the BOP-2: Proc

### Default setting 17: "2-wire (forw/backw1)"

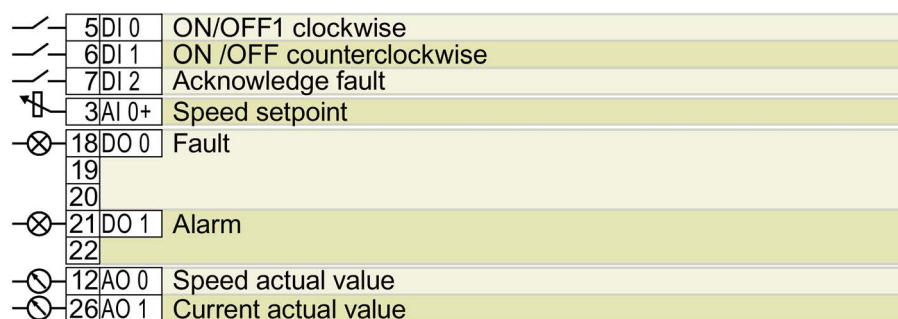

DO 0: p0730,      AO 0: p0771[0], AO 1: p0771[1]    DI 0: r0722.2, ..., DI 2: r0722.2    AI 0: r0755[0]  
DO 1: p0731

Speed setpoint (main setpoint): p1070[0] = 755[0]

Designation in the BOP-2: 2-wlrE 1

**Default setting 18: "2-wire (forw/backw2)"**

—	5	DI 0	ON/OFF1 clockwise
—	6	DI 1	ON /OFF counterclockwise
—	7	DI 2	Acknowledge fault
↕	3	AI 0+	Speed setpoint
⊗	18	DO 0	Fault
	19		
	20		
⊗	21	DO 1	Alarm
	22		
⊖	12	AO 0	Speed actual value
⊖	26	AO 1	Current actual value

DO 0: p0730,      AO 0: p0771[0], AO 1: p0771[1]      DI 0: r0722.0, ..., DI 2: r0722.2      AI 0: r0755[0]  
 DO 1: p0731  
 Speed setpoint (main setpoint): p1070[0] = 755[0]  
 Designation in the BOP-2: 2-wlrE 2

**Default setting 19: "3-wire (enable/forw/backw)"**

—	5	DI 0	Enable / OFF1
—	6	DI 1	ON clockwise
—	7	DI 2	ON counterclockwise
—	16	DI 4	Acknowledge fault
↕	3	AI 0+	Speed setpoint
⊗	18	DO 0	Fault
	19		
	20		
⊗	21	DO 1	Alarm
	22		
⊖	12	AO 0	Speed actual value
⊖	26	AO 1	Current actual value

DO 0: p0730,      AO 0: p0771[0], AO 1: p0771[1]      DI 0: r0722.0, ..., DI 4: r0722.4      AI 0: r0755[0]  
 DO 1: p0731  
 Speed setpoint (main setpoint): p1070[0] = 755[0]  
 Designation in the BOP-2: 3-wlrE 1

**Default setting 20: "3-wire (enable/on/reverse)"**

5	DI 0	Enable / OFF1
6	DI 1	ON
7	DI 2	Reversing
16	DI 4	Acknowledge fault
3	AI 0+	Speed setpoint
18	DO 0	Fault
19		
20		
21	DO 1	Alarm
22		
12	AO 0	Speed actual value
26	AO 1	Current actual value

DO 0: p0730, AO 0: p0771[0], AO 1: p0771[1] DI 0: r0722.0, ..., DI 4: r0722.4 AI 0: r0755[0]  
DO 1: p0731

Speed setpoint (main setpoint): p1070[0] = 755[0]

Designation in the BOP-2: 3-wlrE 2

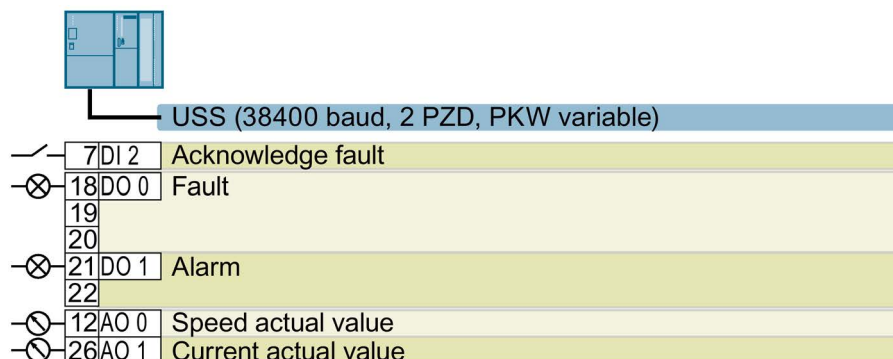
**Default setting 21: "USS fieldbus"**

DO 0: p0730, DO 1: p0731 AO 0: p0771[0], AO 1: p0771[1] DI 2: r0722.2

Speed setpoint (main setpoint): p1070[0] = 2050[1]

Designation in the BOP-2: FB USS

### 4.6.4.3 Safety input

#### Which devices are you allowed to connect?

The safety-related input is designed for the following devices:

- Connection of safety sensors, e.g. emergency stop command devices or light curtains.
- Connection of pre-processing devices, e.g. fail-safe control systems and safety relays.

#### Signal state

The inverter expects signals with the same state at its safety-related input:

- High signal: The safety function is deselected.
- Low signal: The safety function is selected.

#### Connect P/P and P/M-switching safe outputs



It is permissible to connect PP and PM-switching safe outputs to a safe input.

#### Fault detection

The inverter evaluates deviations in the two signals of the safety-related input. The inverter thus detects, for example the following faults:

- Cable break
- Defective sensor

The inverter cannot detect the following faults:

- Cross-circuit of the two cables
- Short-circuit between signal cable and 24 V power supply

#### Special measures to prevent cross-circuits and short-circuits

The routing of cables over longer distances, e.g. between remote control cabinets, increases the risk of damaging cables. Damaged cables raise the risk of an undetected cross-circuit with power-conducting cables laid in parallel. A cross-circuit can cause interruption to the transfer of safety-related signals.

To reduce the risk of cable damage, you need to lay signal lines in steel pipes.

#### Bright and dark test

The inverter filters signal changes using bright and dark tests at its safe input using an adjustable software filter.

 Connecting the safety-related input (Page 499)

## 4.6.5 Wiring the terminal strip



### WARNING

#### Danger to life as a result of hazardous voltages when connecting an unsuitable power supply

Death or serious injury can result when live parts are touched in the event of a fault.

- For all connections and terminals of the electronic boards, only use power supplies that provide PELV (Protective Extra Low Voltage) or SELV (Safety Extra Low Voltage) output voltages.



### WARNING

#### Danger to life due to electric shock caused by sparkovers to the motor temperature sensor cable

Voltage flashovers to the electronics of the inverter can occur in motors without safe electrical separation of the temperature sensors in accordance with IEC 61800-5-1 when the motor develops a fault.

- Install a temperature monitoring relay 3RS1... or 3RS2...
- Evaluate the temperature monitoring relay output using a digital input of the inverter, e.g. using the "External fault" function.



You can find additional information about the temperature monitoring relay on the Internet:

Manual 3RS1 / 3RS2 temperature monitoring relays

(<https://support.industry.siemens.com/cs/ww/en/view/54999309>)

### Note

If your application requires UL certification, please note that the power supply of the digital output must comply with specific specifications.



Technical data (Page 423)

### NOTICE

#### Damage to the inverter when using long signal cables

Using long cables at the inverter's digital inputs and 24 V power supply can lead to overvoltage during switching operations. Overvoltages can damage the inverter.

- If you use cables of more than 30 m at the digital inputs and 24 V power supply, connect an overvoltage protection element between the terminal and the associated reference potential.  
We recommend using the Weidmüller overvoltage protection terminal with designation MCZ OVP TAZ DIODE 24VDC.

Table 4- 14 Permissible cable and wiring options

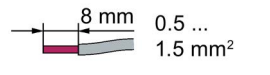
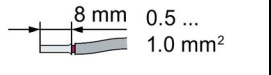
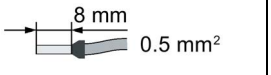
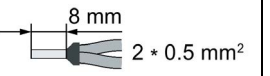
Solid or flexible conductors	Finely stranded conductor with non-insulated end sleeve	Finely stranded conductor with partially insulated end sleeve	Two finely stranded conductors with the same cross-section with partially insulated twin end sleeves
 8 mm 0.5 ... 1.5 mm <sup>2</sup>	 8 mm 0.5 ... 1.0 mm <sup>2</sup>	 8 mm 0.5 mm <sup>2</sup>	 8 mm 2 * 0.5 mm <sup>2</sup>

### Wiring the terminal strip in compliance with EMC

- If you use shielded cables, then you must connect the shield to the mounting plate of the control cabinet or with the shield support of the inverter through a good electrical connection and a large surface area.



Further information about EMC-compliant wiring is available on the Internet:

EMC installation guideline

(<http://support.automation.siemens.com/WW/view/en/60612658>)

- Use the shield connection plate of the Control Unit as strain relief.



Overview of Control Units (Page 29)

### 4.6.6 Monitoring the temperature of the braking resistor



#### WARNING

**Danger to life due to fire spreading because of an unsuitable or improperly installed braking resistor**

Using an unsuitable or improperly installed braking resistor can cause fires and smoke to develop. Fire and smoke development can cause severe personal injury or material damage.

- Only use braking resistors that are approved for the inverter.
- Install the braking resistor in accordance with regulations.
- Monitor the temperature of the braking resistor.



### Procedure

- ➔ 1 Proceed as follows to monitor the braking resistor temperature:
- ➔ 2 1. Connect the temperature monitoring system of the braking resistor (terminals T1 and T2 on the braking resistor) to a free digital input on the inverter.

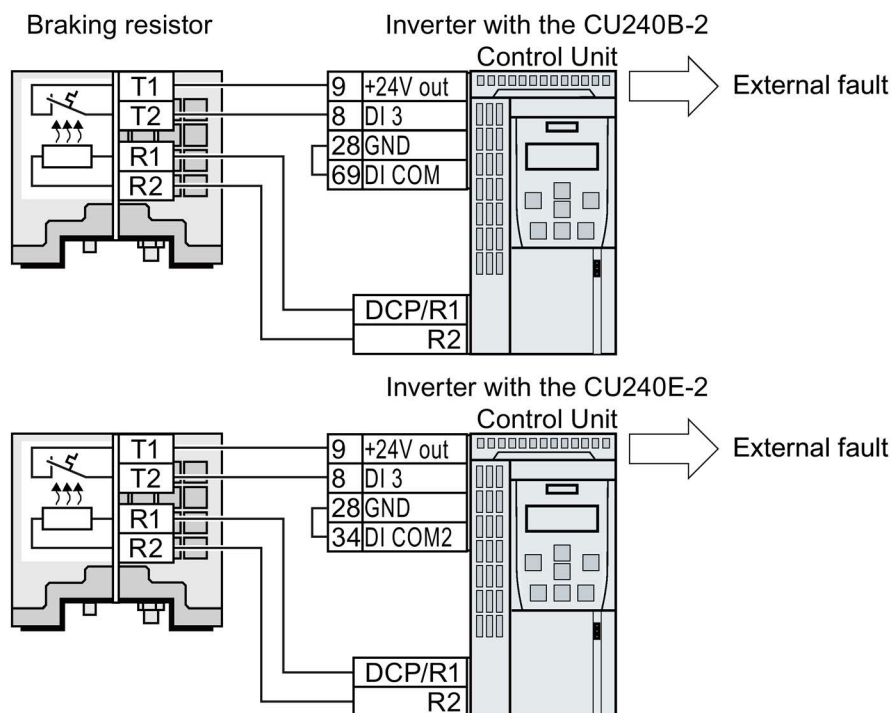

Image 4-16 Example: Temperature monitoring of the braking resistor via digital input DI 3 on the Control Unit

2. Define the function of the digital input used as an external fault with p2106.



As an example with temperature monitoring via digital input DI 3: p2106 = 722.3.

- You have ensured that the temperature is monitored.

## 4.7 Connecting the inverter to the fieldbus

### Fieldbus interfaces of the Control Units

The Control Units are available in different versions for communication with higher-level controls with the subsequently listed fieldbus interfaces:

Fieldbus	Profiles			S7 communication <sup>2)</sup>	Control Unit
	PROFIdrive	PROFIsafe <sup>1)</sup>	PROFIenergy <sup>2)</sup>		
 PROFIBUS (Page 123)	✓	✓	---	✓	CU240B-2 DP CU240E-2 DP CU240E-2 DP-F
 PROFINET (Page 119)	✓	✓	✓	✓	CU240E-2 PN CU240E-2 PN-F
EtherNet/IP <sup>2)</sup>	---			---	
USS <sup>2)</sup>	---			---	CU240B-2 CU240E-2 CU240E-2 F
Modbus RTU <sup>2)</sup>	---			---	

<sup>1)</sup> Information on PROFIsafe can be found in the "Safety Integrated" function manual.

<sup>2)</sup> Information about these fieldbuses, profiles and communication types can be found in the "Fieldbus" function manual.

 Overview of the manuals (Page 507)

## 4.7.1 PROFINET

You can either communicate via Ethernet using the inverter, or integrate the inverter in a PROFINET network.

### The inverter as Ethernet node

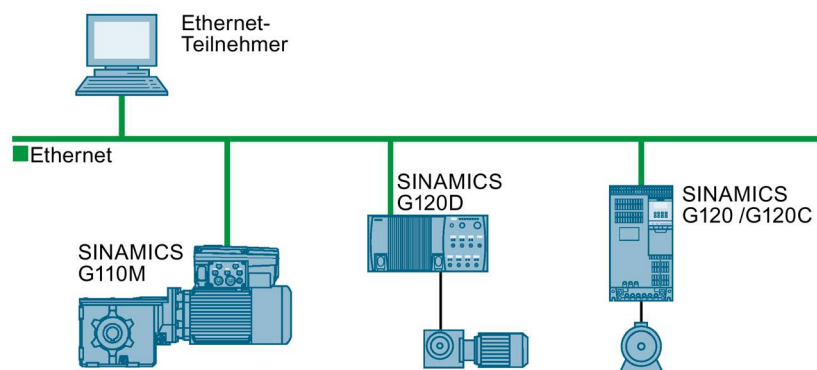

Image 4-17 The inverter as Ethernet node

### The inverter in PROFINET IO operation

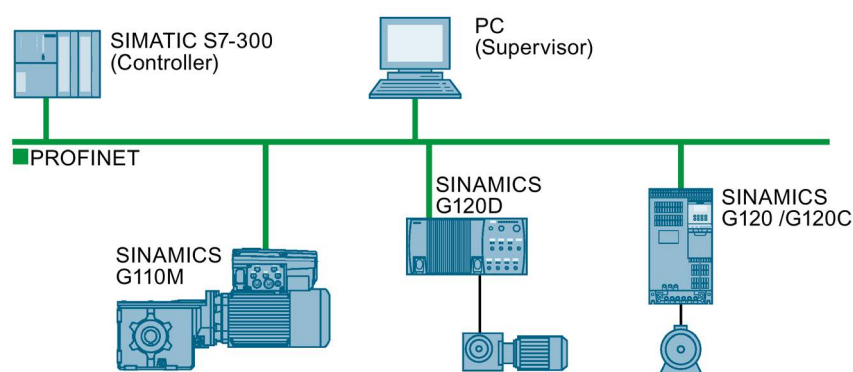

Image 4-18 The inverter in PROFINET IO operation

In PROFINET IO operation, the inverter supports the following functions:

- RT
- IRT: The inverter forwards the clock synchronism, but does not support clock synchronism.
- MRP: Media redundancy, impulsed with 200 ms. Requirement: Ring topology
- MRPD: Media redundancy, bumpless. Requirement: IRT and the ring topology created in the control
- Diagnostic alarms in accordance with the error classes specified in the PROFIdrive profile.

- Device replacement without removable data storage medium. Requirement: Topology created in the control
- Shared Device for Control Units with fail-safe functions

**General information about PROFINET**

You can find general information about PROFINET in the Internet:



- General information about PROFINET: Industrial Communication (<http://www.automation.siemens.com/mcms/automation/en/industrial-communications/profinet/Pages/Default.aspx>).
- Configuring the functions: PROFINET system description (<http://support.automation.siemens.com/WW/view/en/19292127>).

This manual describes the control of the inverter using primary control. Accessing the inverter as an Ethernet node is described in the "Fieldbus" function manual.

Overview of the manuals (Page 507)

**4.7.1.1 What do you need for communication via PROFINET?**

Check the communication settings using the following table. If you answer "Yes" to the questions, you have correctly set the communication settings and can control the inverter via the fieldbus.

Questions	Answer/description	Example
Is the inverter correctly connected to the bus network?	Integrating inverters into PROFINET (Page 121)	
Do the IP address and device name in the inverter and control match?	Configuring communication to the control (Page 121)	Inverter manuals, "Fieldbus" function manual (Page 507)
Is the same telegram set in the inverter as in the higher-level control?	Setting the telegram in the control	
Are the signals that the inverter and the control exchange via PROFINET correctly interconnected?	Interconnect signals PROFIdrive-conform in the inverter. Control via PROFIBUS or PROFINET with the PROFIdrive profile (Page 193)	

### 4.7.1.2 Integrating inverters into PROFINET

#### Procedure



To connect the inverter to a control via PROFINET, proceed as follows:

1. Integrate the inverter in the bus system (e.g. ring topology) of the control using PROFINET cables and the two PROFINET sockets X150-P1 and X150-P2.



Fieldbus interface allocation (Page 92)

The maximum permitted cable length from the previous station and to the next one is 100 m.

2. Externally supply the inverter with 24 VDC through terminals 31 and 32.

The external 24 V supply is only required if communications with the control should also run when the line voltage is switched off.



You have connected the inverter to the control using PROFINET.

### 4.7.1.3 Configuring communication to the control

#### Configuring the communication with a SIMATIC S7 control

You have the following options, if the inverter is not included in the hardware library:

- Install the most up to date STARTER version
- Install the GSDML of the inverter using "Tools/Install GSDML file" in HW Config.

Further information is provided in the Fieldbus function manual.



Overview of the manuals (Page 507)

#### Configuring the communication with a non-Siemens control

1. Import the device file (GSDML) of the inverter into the engineering tool for your control system.
2. Configure the communication.

#### 4.7.1.4 Installing GSDML

##### Procedure



1 To install the GSDML of the inverter into the configuring tool of your control system, proceed  
2 as follows:

1. Save the GSDML to your PC .



– From the Internet: GSDML  
(<http://support.automation.siemens.com/WW/view/en/22339653/133100>).

– From your inverter:

Insert a memory card into the inverter.

Set p0804 = 12.

The inverter writes the GSDML as zipped file (\*.zip) into directory  
/SIEMENS/SINAMICS/DATA/CFG on the memory card.

2. Unzip the GSDML file to a folder on your computer.

3. Import the GSDML into the configuring tool of your control system.



You have now installed the GSDML.

## 4.7.2 PROFIBUS

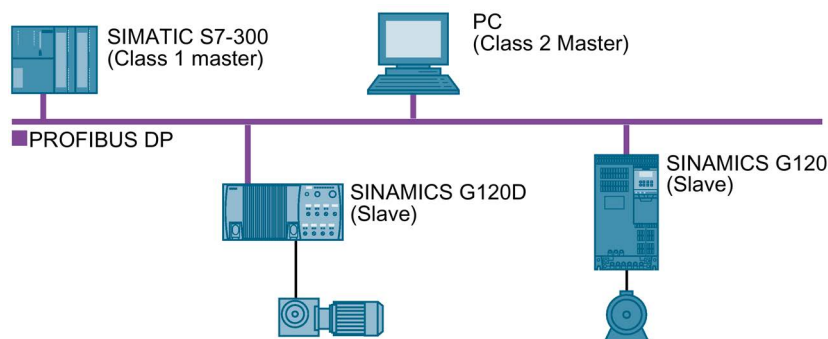

The PROFIBUS DP interface has the following functions:

- Cyclic communication
- Acyclic communication
- Diagnostic alarms



General information on PROFIBUS DP can be found in the Internet:

- PROFIBUS user organization (<http://www.profibus.com/downloads/installation-guide/>)
- Information about PROFIBUS DP ([http://www.automation.siemens.com/net/html\\_76/support/printkatalog.htm](http://www.automation.siemens.com/net/html_76/support/printkatalog.htm))

### 4.7.2.1 What do you need for communication via PROFIBUS?

Check the communication settings using the following table. If you answer "Yes" to the questions, you have correctly set the communication settings and can control the inverter via the fieldbus.

Questions	Description	Examples
Is the inverter correctly connected to the PROFIBUS?	Integrating inverters into PROFIBUS (Page 124)	---
Have you configured the communication between the inverter and the higher-level control?	Configuring the communication using SIMATIC S7 control (Page 124)	Overview of the manuals (Page 507)
Do the addresses in the inverter and the higher-level control match?	Setting the address (Page 125)	
Is the same telegram set in the higher-level control and in the inverter?	Setting the telegram in the control	
Are the signals that the inverter and the control exchange via PROFIBUS correctly interconnected?	Interconnect signals PROFIdrive-conform in the inverter. Control via PROFIBUS or PROFINET with the PROFIdrive profile (Page 193)	

### 4.7.2.2 Integrating inverters into PROFIBUS

#### Procedure



To connect the inverter to a control via PROFIBUS DP, proceed as follows:

1. Integrate the inverter into the bus system (e.g. line topology) of the control using PROFIBUS cables via socket X126.



Overview of the interfaces (Page 91)

The maximum permitted cable length to the previous station and the subsequent one is 100 m at a baud rate of 12 Mbit/s.

2. Externally supply the inverter with 24 VDC through terminals 31 and 32.

The external 24 V supply is only required if communications with the control should also run when the line voltage is switched off.



You have now connected the inverter to the control using PROFIBUS DP.

#### Communication with the controller even when the supply voltage on the Power Module is switched off

You must supply the Control Unit with 24 V DC at terminals 31 and 32 if you wish to maintain communication with the control system when the line voltage is switched off.

In the case of brief interruptions of the 24 V power supply, the inverter may signal a fault without communications with the control system being interrupted.

### 4.7.2.3 Configuring the communication using SIMATIC S7 control

- If the inverter is listed in the hardware library of HW-Conifg, you can configure the communication in the SIMATIC control.
- If the inverter is not listed in the hardware library, you can either install the newest STARTER or Startdrive version or install the GSD of the inverter via "Extras/GSD-Install file" in HW-Config.



#### 4.7.2.4 Installing the GSD

##### Procedure



1 To load the GSD of the inverter in the control, proceed as follows:

2 1. Obtain the GSD

- either on the Internet:



GSD (<http://support.automation.siemens.com/WW/view/en/22339653/133100>)

- or from your inverter. To do this, insert a memory card into the inverter and set p0804 = 12. In this way, you will save the GSD on the memory card as (DPGSD.ZIP) compressed file in the directory /SIEMENS/SINAMICS/DATA/CFG .

2. Unzip the GSDfile in a folder on your computer.

3. Import the GSD into the configuration tool of your control.



You have now installed the GSD file.

#### 4.7.2.5 Setting the address

Bit 6 (64)	■
Bit 5 (32)	■
Bit 4 (16)	■
Bit 3 (8)	■
Bit 2 (4)	■
Bit 1 (2)	■
Bit 0 (1)	■
On	Off

Example:

	■
	■
	■
8	■
	■
2	■
	■
= 10	■
On	Off

You set the PROFIBUS address of the inverter using the address switch on the Control Unit, in parameter p0918 or in STARTER.

In parameter p0918 (factory setting: 126) or in STARTER, you can only set the address, if all address switches are set to "OFF" (0) or "ON" (1).

If you have specified a valid address with the address switches, this address will always be the one that takes effect and parameter p0918 cannot be changed.

Valid address range: 1 ... 125



Overview of the interfaces (Page 91)

##### Procedure



1 To change the bus address, proceed as follows:

2 1. Set the address using one of the subsequently listed options:

- using the address switch
- from an operator panel using parameter p0918
- in STARTER using screen form "Control Unit/Communication/PROFIBUS" – or using the expert list in parameter p0918

After you have changed the address in STARTER, carry out RAM to ROM ().

2. Switch off the inverter supply voltage.

*4.7 Connecting the inverter to the fieldbus*

3. Wait until all LEDs on the inverter go dark.

4. Switch on the inverter supply voltage again.

Your settings become active after switching on.





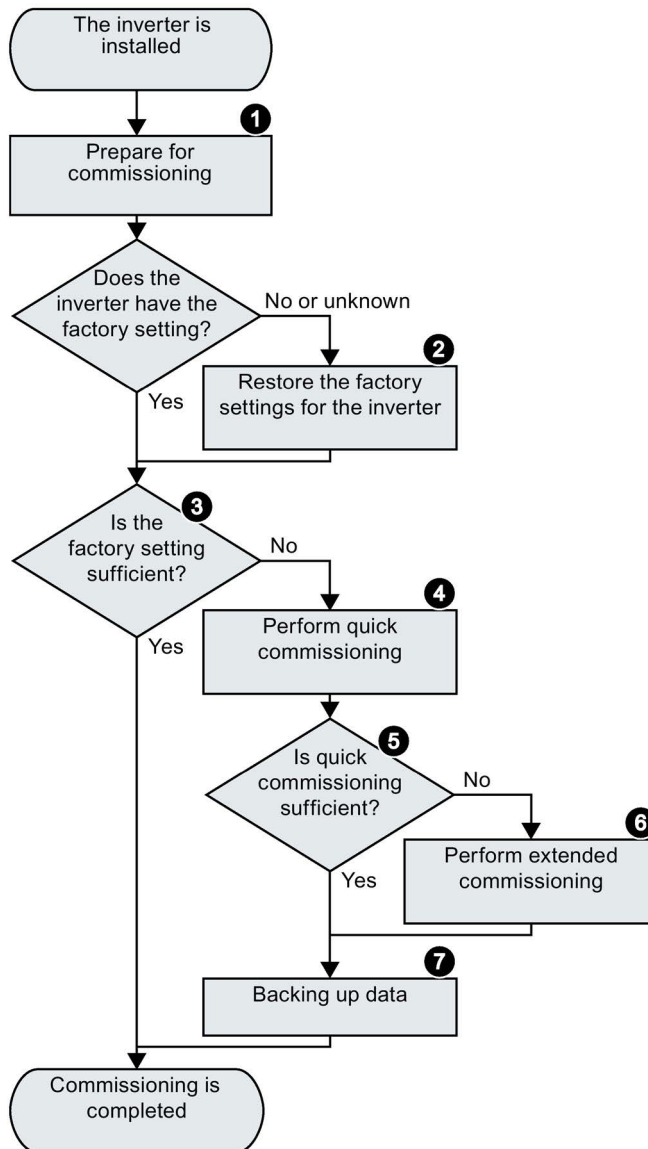

You have now changed the bus address.

## Commissioning

### 5.1 Commissioning guidelines

#### Overview



1. Define the requirements to be met by the drive for your application.  
 (Page 128)
2. Restore the factory settings of the inverter if necessary.  
 (Page 162)
3. Check if the factory setting of the inverter is sufficient for your application.  
 (Page 129)
4. Set the following for quick commissioning of the drive:
  - The closed-loop motor control
  - The inputs and outputs
  - The fieldbus interface (Page 131)
5. Check if additional inverter functions are required for the application.  
 (Page 169)
6. If necessary, adapt the drive.  
 (Page 169)
7. Save your settings.  
 (Page 351)

## 5.2 Preparing for commissioning

### 5.2.1 Collecting motor data

Before starting commissioning, you must know the following data:

- Which motor is connected to the inverter?

Note down the Article No. of the motor and the motor's nameplate data.

If available, note down the motor code on the motor's nameplate.

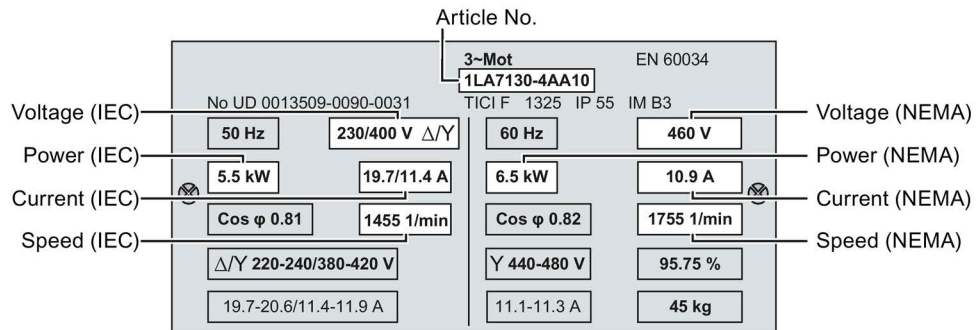

- In which region of the world is the motor to be used?

- Europe IEC: 50 Hz [kW]
- North America NEMA: 60 Hz [hp] or 60 Hz [kW]

- How is the motor connected?

Pay attention to the connection of the motor (star connection [Y] or delta connection [Δ]). Note the appropriate motor data for connecting.

## 5.2.2 Inverter factory setting

### Motor



In the factory, the inverter is set for an induction motor matching the rated power of the Power Module.

### Inverter control

You can find the factory settings for the inverter control in the following Chapters:

### Inverter interfaces

The inputs and outputs and the fieldbus interface of the inverter have specific functions when set to the factory settings.

-  Factory setting of the CU240B-2 interfaces (Page 95)
-  Factory setting of the CU240E-2 interfaces (Page 102)

### Switching the motor on and off

The inverter is set in the factory as follows:

- After the ON command, the motor accelerates with a ramp-up time of 10 s (referred to 1500 rpm) to its speed setpoint.
- After the OFF1 command, the motor brakes down to standstill with the ramp-down time.
- The motor direction of rotation reverses with the reversing command.

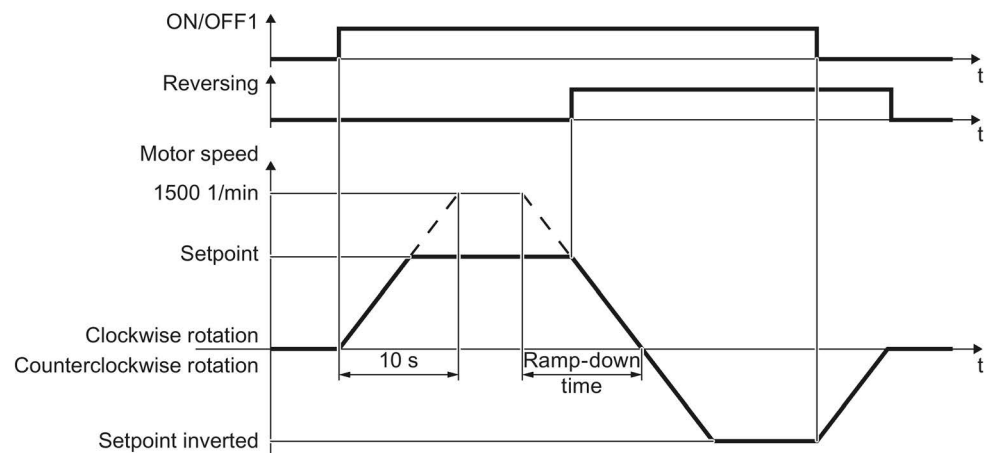

- Ramp-down time:
- With the PM230 Power Module: 30 s
  - For all other Power Modules: 10 s

Image 5-1 Switching on and switching off the motor and reversing in the factory setting

The ramp-up and ramp-down times define the maximum motor acceleration when the speed setpoint changes. The ramp-up and ramp-down time is the time between motor standstill and the maximum speed, or between the maximum speed and motor standstill.

### Traverse the motor in the jog mode

For an inverter with PROFIBUS or PROFINET interface, operation can be switched over using digital input DI 3. The motor is either switched on and off via the fieldbus – or operated in the jog mode via its digital inputs.

For a control command at the respective digital input, the motor rotates with  $\pm 150$  rpm. The same ramp-up and ramp-down times as described above apply.

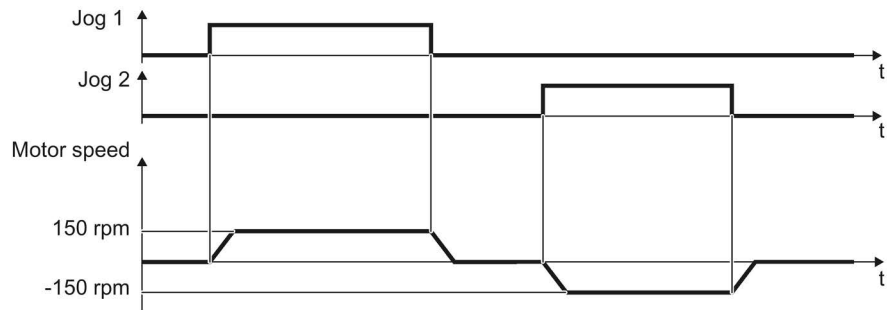

Image 5-2 Jogging the motor in the factory setting

### Minimum and maximum speed

- Minimum speed - factory setting 0 [rpm]

The minimum speed is the lowest speed of the motor independent of the speed setpoint. A minimum speed is, for example, useful for fans or pumps.

- Maximum speed - factory setting 1500 [rpm]

The inverter limits the motor speed to this value.

### Operate the inverter with the factory setting

For basic applications, you can try to operate the drive with a rated power  $< 18.5$  kW without any other commissioning steps. Check whether the control quality of the drive without commissioning is adequate for the requirements of the application.

We recommend that you configure the drive with the precise motor data.

## 5.3 Quick commissioning using the BOP-2 operator panel

### 5.3.1 Inserting the BOP-2

#### Plugging on an operator panel

##### Procedure



To plug an Operator Panel on the Control Unit, proceed as follows:

1. Locate the lower edge of the Operator Panel into the matching recess of the Control Unit.
2. Press the Operator Panel onto the inverter until you hear the latching mechanism engage.



You have plugged an operator panel onto the Control Unit.

The operator panel is ready for operation when you connect the inverter to the power supply.

5.3.2 Overview

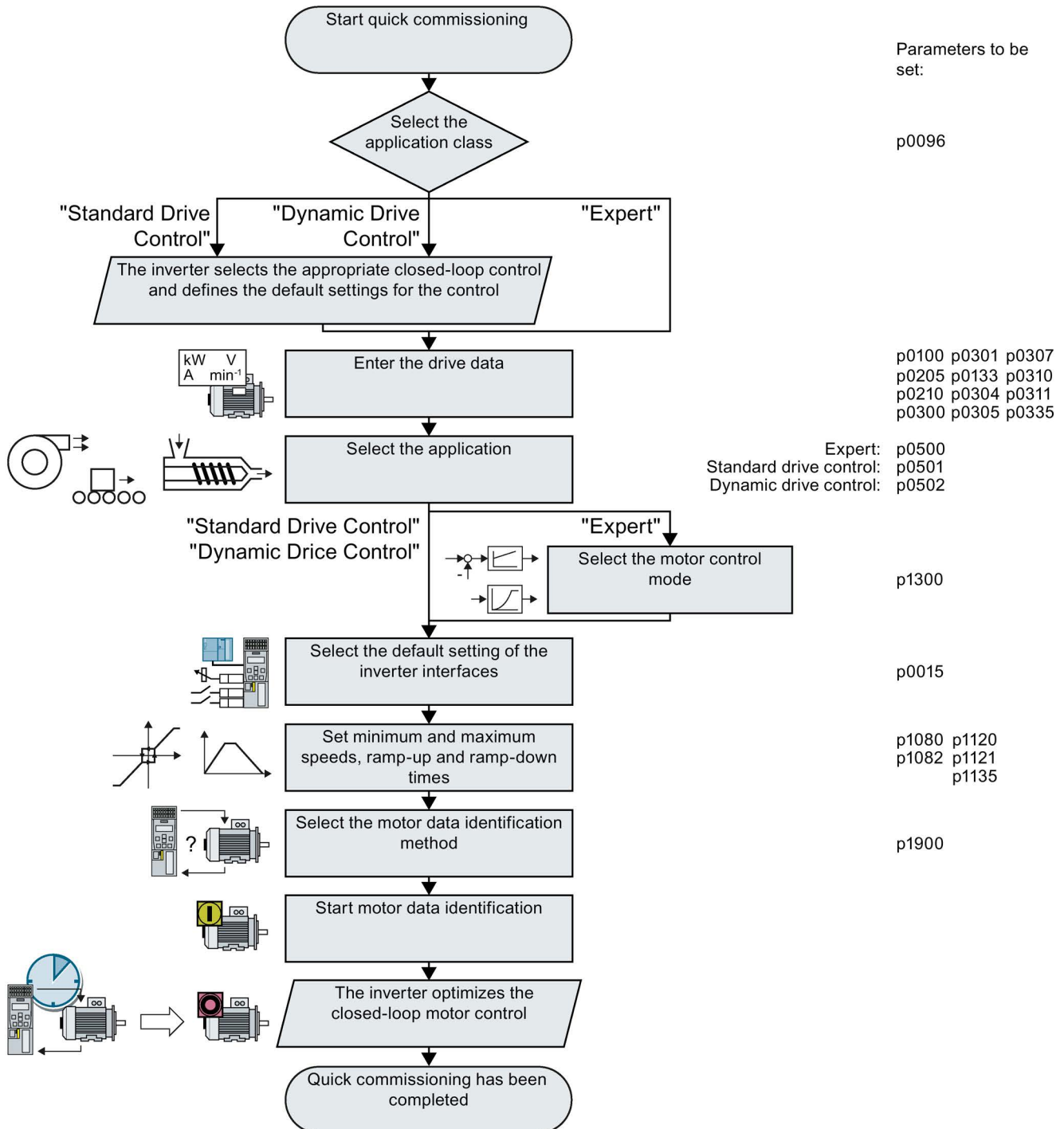

Image 5-3 Quick commissioning using the BOP-2 operator panel



### 5.3.3 Starting quick commissioning

#### Carrying out quick commissioning

##### Preconditions









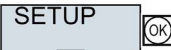

- The power supply is switched on.
- The operator panel displays setpoints and actual values.

##### Procedure



1 Proceed as follows to carry out quick commissioning:

1.  Press the ESC key.
2.  Press one of the arrow keys until the BOP-2 displays the "SETUP" menu.
3.  In the "SETUP" menu, press the OK key to start quick commissioning.
4.  If you wish to restore all of the parameters to the factory setting before the quick commissioning:
  - 4.1. Switchover the display using an arrow key: nO → YES
  - 4.2. Press the OK key.
5.  When selecting an application class, the inverter assigns the motor control with the appropriate default settings:
 







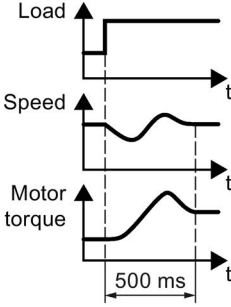
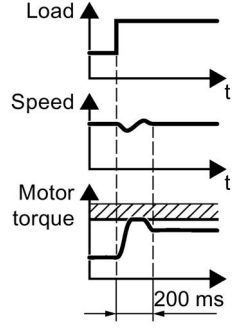

STANDARD		Standard Drive Control (Page 135)
DYNAMIC		Dynamic Drive Control (Page 138)
EXPERT		If you select this setting or if no application class is listed:
		Expert (Page 141)

### Selecting a suitable application class

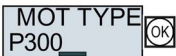
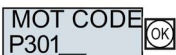
When selecting an application class, the inverter assigns the appropriate settings to the motor control.

Application class	Standard Drive Control	Dynamic Drive Control
<b>Motors that can be operated</b>	Induction motors	Induction and synchronous motors
<b>Power Modules that can be operated</b>	PM240, PM240-2, PM340	
<b>Application examples</b>	<ul style="list-style-type: none"> <li>• Pumps, fans, and compressors with flow characteristic</li> <li>• Wet or dry blasting technology</li> <li>• Mills, mixers, kneaders, crushers, agitators</li> <li>• Horizontal conveyor technology (conveyor belts, roller conveyors, chain conveyors)</li> <li>• Basic spindles</li> </ul>	<ul style="list-style-type: none"> <li>• Pumps and compressors with displacement machines</li> <li>• Rotary furnaces</li> <li>• Extruder</li> <li>• Centrifuge</li> </ul>
<b>Properties</b>	<ul style="list-style-type: none"> <li>• Typical correction time after a speed change: 100 ms ... 200 ms</li> <li>• Typical correction time after a load surge: 500 ms</li> <li>• Standard Drive Control is suitable for the following requirements:                             <ul style="list-style-type: none"> <li>– Motor power ratings &lt; 45 kW</li> <li>– Acceleration time 0 → rated speed (depending on the rated motor power): 1 s (0.1 kW) ... 10 s (45 kW)</li> <li>– Applications with increasing load torque without load surges</li> </ul> </li> <li>• Standard Drive Control is insensitive with respect to inaccurate motor data settings</li> </ul> 	<ul style="list-style-type: none"> <li>• Typical correction time after a speed change: &lt; 100 ms</li> <li>• Typical correction time after a load surge: 200 ms</li> <li>• Dynamic Drive Control controls and limits the motor torque</li> <li>• Torque accuracy that can be achieved: ± 5 % for 15 % ... 100 % of the rated speed</li> <li>• We recommend Dynamic Drive Control for the following applications:                             <ul style="list-style-type: none"> <li>– Motor power ratings &gt; 11 kW</li> <li>– For load surges of 10 % ... &gt;100 % of the rated motor torque</li> </ul> </li> <li>• Dynamic Drive Control is necessary for a ramp-up time 0 → rated speed (dependent on the rated motor power): &lt; 1 s (0.1 kW) ... &lt; 10 s (250 kW).</li> </ul> 
<b>Max. output frequency</b>	550 Hz	240 Hz
<b>Torque control</b>	Without torque control	Speed control with lower-level torque control
<b>Commissioning</b>	<ul style="list-style-type: none"> <li>• Contrary to "Dynamic Drive Control" a speed controller does not have to be set</li> <li>• In comparison to "Configuration for experts":                             <ul style="list-style-type: none"> <li>– Simplified commissioning using preassigned motor data</li> <li>– Reduced number of parameters</li> </ul> </li> </ul>	<ul style="list-style-type: none"> <li>• Reduced number of parameters when compared to "Configuration for experts"</li> </ul>

### 5.3.4 Standard Drive Control

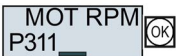
6.  Motor standard  
 KW 50HZ IEC  
 HP 60HZ NEMA  
 KW 60HZ IEC 60 Hz
7.  Supply voltage for the inverter
8. Enter the motor data:
- 8.1.  Motor type  
 Depending on the particular inverter, it is possible that the BOP-2 does not list all of the following motor types.  
 INDUCT Third-party induction motor  
 SYNC Third-party synchronous motor  
 RELUCT Third-party reluctance motor  
 1L... IND 1LE1, 1LG6, 1LA7, 1LA9 induction motors  
 1LE1 IND 1LE1□9 with motor code on the rating plate  
 100  
 1PC1 IND 1PC1 with motor code on the rating plate  
 1PH8 IND Induction motor  
 1FP1 Reluctance motor  
 1F... SYN 1FG1, 1FK7 synchronous motor, without encoder
- 8.2.  If you have selected a motor type > 100, then you must enter the motor code:  
 With the correct motor code, the inverter assigns the motor data the following values.  
 If you do not know the motor code, then you must set the motor code = 0, and enter the motor data from p0304 and onwards from the rating plate.
- 8.3.  87 Hz motor operation  
 The BOP-2 only displays this step if you previously selected IEC as the motor standard (EUR/USA, P100 = KW 50HZ).
- 8.4.  Rated voltage
- 8.5.  Rated current
- 8.6.  Rated power
- 8.7.  Rated frequency
- 8.8.  Rated speed

- 8.9. MOT COOL  
P335 Motor cooling

  - SELF      Natural cooling
  - FORCED    Forced-air cooling
  - LIQUID    Liquid cooling
  - NO FAN    Without fan
- 9. TEC APPL  
P501 Select the application:

  - VEC STD    Constant load: Typical applications include belt conveyor drives.
  - PUMP FAN    Speed-dependent load: Typical applications include pumps and fans.
- 10. MAc PAR  
P15 Select the default setting for the interfaces of the inverter that is suitable for your application.

  - Default settings of the CU240B-2 interfaces (Page 97)
  - Default settings of the CU240E-2 interfaces (Page 104)
- 11. MIN RPM  
P1080 Minimum and maximum motor speed
- 12. MAX RPM  
P1082
- 13. RAMP UP  
P1120 Motor ramp-up time
- 14. RAMP DWN  
P1121 Motor ramp-down time
- 15. OFF3 RP  
P1135 Ramp-down time for the OFF3 command

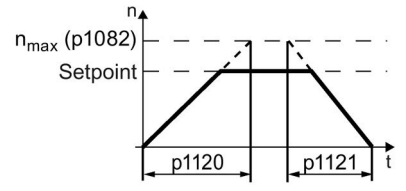
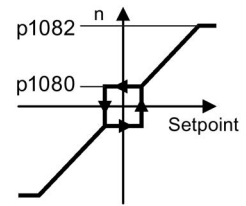













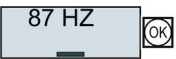
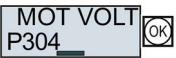

16.  Motor data identification
- Select the method which the inverter uses to measure the data of the connected motor:
- OFF Motor data is not measured.
  - STIL ROT Recommended setting: Measure the motor data at standstill and with the motor rotating. The inverter switches off the motor after the motor data identification has been completed.
  - STILL Measure the motor data at standstill. The inverter switches off the motor after the motor data identification has been completed.  
Select this setting if the motor cannot freely rotate, e.g. for a mechanically limited traversing range.
  - ROT Measure the motor data while it is rotating. The inverter switches off the motor after the motor data identification has been completed.
  - ST RT OP Setting the same as STIL ROT.  
After the motor data identification, the motor accelerates to the currently set setpoint.
  - STILL OP Setting the same as STILL.  
After the motor data identification, the motor accelerates to the currently set setpoint.

17.  Complete quick commissioning:
- 17.1. Switchover the display using an arrow key: nO → YES
  - 17.2. Press the OK key.

 You have completed quick commissioning.

### 5.3.5 Dynamic Drive Control

6.  Motor standard  
 KW 50HZ IEC  
 HP 60HZ NEMA  
 KW 60HZ IEC 60 Hz
7.  Supply voltage for the inverter
8. Enter the motor data:
  - 8.1.  Motor type  
 Depending on the particular inverter, it is possible that the BOP-2 does not list all of the following motor types.  
 INDUCT Third-party induction motor  
 SYNC Third-party synchronous motor  
 RELUCT Third-party reluctance motor  
 1L... IND 1LE1, 1LG6, 1LA7, 1LA9 induction motors  
 1LE1 IND 1LE1□9 with motor code on the rating plate 100  
 1PC1 IND 1PC1 with motor code on the rating plate  
 1PH8 IND Induction motor  
 1FP1 Reluctance motor  
 1F... SYN 1FG1, 1FK7 synchronous motor, without encoder
  - 8.2.  If you have selected a motor type > 100, then you must enter the motor code:  
 With the correct motor code, the inverter assigns the motor data the following values.  
 If you do not know the motor code, then you must set the motor code = 0, and enter the motor data from p0304 and onwards from the rating plate.
  - 8.3.  87 Hz motor operation  
 The BOP-2 only displays this step if you previously selected IEC as the motor standard (EUR/USA, P100 = KW 50HZ).
  - 8.4.  Rated voltage
  - 8.5.  Rated current
  - 8.6.  Rated power
  - 8.7.  Rated frequency
  - 8.8.  Rated speed

- 8.9.  Motor cooling
- |        |                    |
|--------|--------------------|
| SELF   | Natural cooling    |
| FORCED | Forced-air cooling |
| LIQUID | Liquid cooling     |
| NO FAN | Without fan        |
9.  Select the application:
- |          |  |
|----------|--|
| OP LOOP  | Recommended setting for standard applications.   |
| CL LOOP  | Recommended setting for applications with short ramp-up and ramp-down times. This setting is not suitable for hoisting gear and cranes/lifting gear. |
| HVY LOAD | Recommended setting for applications with a high break loose torque.   |
10.  Select the default setting for the interfaces of the inverter that is suitable for your application.
- |   |  |
|---|--|
|  | Default settings of the CU240B-2 interfaces (Page 97)  |
|  | Default settings of the CU240E-2 interfaces (Page 104) |

11. MIN RPM  
P1080 

Minimum and maximum motor speed

12. MAX RPM  
P1082 

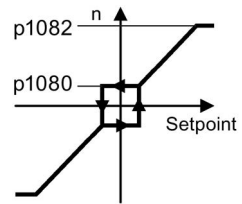



13. RAMP UP  
P1120 

Motor ramp-up time

14. RAMP DWN  
P1121 

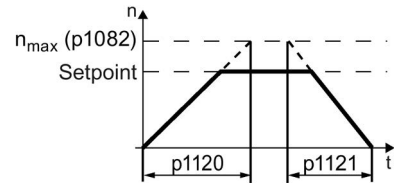
Motor ramp-down time



15. OFF3 RP  
P1135 

Ramp-down time for the OFF3 command

16. MOT ID  
P1900 

Motor data identification

Select the method which the inverter uses to measure the data of the connected motor:

- OFF Motor data is not measured.
- STIL ROT Recommended setting: Measure the motor data at standstill and with the motor rotating.  
The inverter switches off the motor after the motor data identification has been completed.
- STILL Measure the motor data at standstill.  
The inverter switches off the motor after the motor data identification has been completed.  
Select this setting if the motor cannot rotate freely – for example, if the traversing range is mechanically limited.
- ROT Measure the motor data while it is rotating.  
The inverter switches off the motor after the motor data identification has been completed.
- ST RT OP Setting the same as STIL ROT.  
The motor accelerates to the currently set setpoint after the motor data identification.
- STILL OP Setting the same as STILL.  
After the motor data identification, the motor accelerates to the currently set setpoint.

17. FINISH 

Complete quick commissioning:







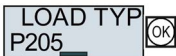

17.1. Switch over the display using an arrow key: nO → YES

17.2. Press the OK key.

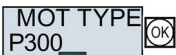
 You have completed quick commissioning.

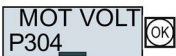

### 5.3.6 Expert

6.  Motor standard  
 KW / 50HZ IEC  
 HP / 60HZ NEMA  
 KW / 60HZ IEC 60 Hz
7. Overload capability and supply voltage of the inverter
- 7.1.  Overload capability  
 HIGH OVL Load cycle with "High Overload"  
 LOW OVL Load cycle with "Low Overload"
- 7.2.  Inverter supply voltage
8. Enter the motor data:
- 8.1.  Motor type  
 Depending on the particular inverter, it is possible that the BOP-2 does not list all of the following motor types.  
 INDUCT Third-party induction motor  
 SYNC Third-party synchronous motor  
 RELUCT Third-party reluctance motor  
 1L... IND 1LE1, 1LG6, 1LA7, 1LA9 induction motors  
 1LE1 IND 1LE1□9 with motor code on the rating plate 100  
 1PC1 IND 1PC1 with motor code on the rating plate  
 1PH8 IND Induction motor  
 1FP1 Reluctance motor  
 1F... SYN 1FG1, 1FK7 synchronous motor, without encoder
- 8.2.  If you have selected a motor type > 100, then you must enter the motor code:  
 With the correct motor code, the inverter assigns the motor data the following values.  
 If you do not know the motor code, then you must set the motor code = 0, and enter the motor data from p0304 and onwards from the rating plate.
- 8.3.  87 Hz motor operation  
 The BOP-2 only displays this step if you previously selected IEC as the motor standard (EUR/USA, P100 = KW 50HZ).
- 8.4.  Rated voltage
- 8.5.  Rated current
- 8.6.  Rated power
- 8.7.  Rated frequency

8.8.  MOT RPM  
P311 OK

Rated speed

8.9.  MOT COOL  
P335 OK

Motor cooling

SELF Natural cooling

FORCED Forced-air cooling

LIQUID Liquid cooling

NO FAN Without fan

9. Application and control mode

9.1.  TEC APPL  
P500 OK

Select the application:

VEC STD In all applications, which do not fit the other setting options.

PUMP FAN Applications involving pumps and fans

SLVC 0HZ Applications with short ramp-up and ramp-down times. However, this setting is not suitable for hoisting gear and cranes/lifting gear.

PUMP 0HZ Setting only for steady-state operation with slow speed changes. We recommend setting VEC STD if load surges in operation cannot be ruled out.

The selection option depends on the Power Module being used. There is no selection option for PM230 Power Modules.

9.2.  CTRL MOD  
P1300 OK

Select the control mode:

VF LIN U/f control with linear characteristic

VF LIN F Flux current control (FCC)

VF QUAD U/f control with square law characteristic

SPD N EN Vector control without encoder

## Select a suitable control mode

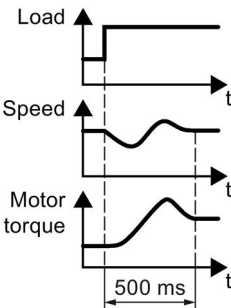
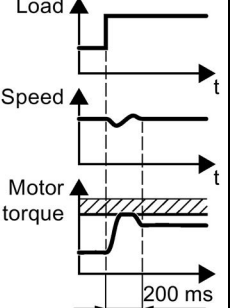
Control mode	U/f control or flux current control (FCC)	Sensorless vector control
Motors that can be operated	Induction motors	Induction and synchronous motors
Power Modules that can be operated	No restrictions	
Application examples	<ul style="list-style-type: none"> <li>• Pumps, fans, and compressors with flow characteristic</li> <li>• Wet or dry blasting technology</li> <li>• Mills, mixers, kneaders, crushers, agitators</li> <li>• Horizontal conveyor technology (conveyor belts, roller conveyors, chain conveyors)</li> <li>• Basic spindles</li> </ul>	<ul style="list-style-type: none"> <li>• Pumps and compressors with displacement machines</li> <li>• Rotary furnaces</li> <li>• Extruder</li> <li>• Centrifuge</li> </ul>
Properties	<ul style="list-style-type: none"> <li>• Typical correction time after a speed change: 100 ms ... 200 ms</li> <li>• Typical correction time after a load surge: 500 ms</li> <li>• The control mode is suitable to address the following requirements: <ul style="list-style-type: none"> <li>– Motor power ratings &lt; 45 kW</li> <li>– Ramp-up time 0 → Rated speed (dependent on the rated motor power): 1 s (0.1 kW) ... 10 s (45 kW)</li> <li>– Applications with constant load torque without load surges</li> </ul> </li> <li>• Die Regelungsart is insensitive with respect to imprecise setting of the motor data</li> </ul> 	<ul style="list-style-type: none"> <li>• Typical correction time after a speed change: &lt; 100 ms</li> <li>• Typical correction time after a load surge: 200 ms</li> <li>• The control mode controls and limits the motor torque</li> <li>• Torque accuracy that can be achieved: <math>\pm 5\%</math> for 15 % ... 100 % of the rated speed</li> <li>• We recommend the control mode for the following applications: <ul style="list-style-type: none"> <li>– Motor power ratings &gt; 11 kW</li> <li>– For load surges of 10 % ... &gt;100 % of the rated motor torque</li> </ul> </li> <li>• The control mode is necessary for a ramp-up time 0 → Rated speed (dependent on the rated motor power): &lt; 1 s (0.1 kW) ... &lt; 10 s (250 kW).</li> </ul> 
Max. output frequency	550 Hz	240 Hz
Closed-loop torque control	Without torque control	Torque control with and without higher-level speed control
Commissioning	<ul style="list-style-type: none"> <li>• Contrary to encoderless vector control, the speed controller does not have to be set</li> </ul>	

10. **MAc PAr**  
P15 

Select the default setting for the interfaces of the inverter that is suitable for your application.



Default settings of the CU240B-2 interfaces (Page 97)



Default settings of the CU240E-2 interfaces (Page 104)

11. **MIN RPM**  
P1080 

Minimum speed of the motor

12. **MAX RPM**  
P1082 

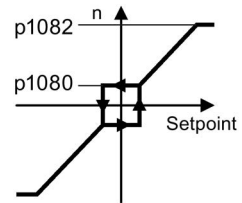



13. **RAMP UP**  
P1120 

Motor ramp-up time.

14. **RAMP DWN**  
P1121 

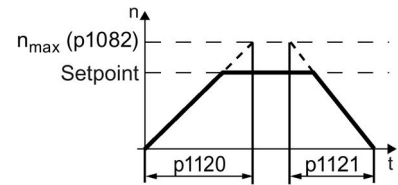
Motor ramp-down time



15. **OFF3 RP**  
P1135 

Ramp-down time for the OFF3 command

16. **MOT ID**  
P1900 

Motor data identification

Select the method which the inverter uses to measure the data of the connected motor:

OFF No measurement of motor data.

STIL ROT Recommended setting: Measure the motor data at standstill and with the motor rotating. The inverter switches off the motor after the motor data identification has been completed.

STILL Measure the motor data at standstill. The inverter switches off the motor after the motor data identification has been completed.

Select this setting if one of the following cases is applicable:

- You have selected control mode "SPD N EN", however, the motor cannot freely rotate - for a mechanically limited travel range, for example.
- You have selected U/f control as control mode, e.g. "VF LIN" or "VF QUAD".



ROT Measuring the motor data while it is rotating. The inverter switches off the motor after the motor data identification has been completed.

ST RT OP Setting the same as STIL ROT.

After the motor data identification, the motor accelerates to the currently set setpoint.

STILL OP Setting the same as STILL.

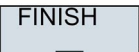
After the motor data identification, the motor accelerates to the currently set setpoint.

17.   Complete quick commissioning:

17.1. Switchover the display using an arrow key: nO → YES

17.2. Press the OK key.

 You have completed quick commissioning.

### 5.3.7 Identifying the motor data and optimizing the closed-loop control

The inverter has several techniques to automatically identify the motor data and optimize the speed control.

To start the motor data identification routine, you must switch-on the motor via the terminal strip, fieldbus or from the operator panel.

 <b>WARNING</b>
<p><b>Risk of death due to machine motion while motor data identification is active</b></p> <p>For the stationary measurement, the motor can make several rotations. The rotating measurement accelerates the motor up to its rated speed. Secure dangerous machine parts before starting motor data identification:</p> <ul style="list-style-type: none"> <li>• Before switching on, ensure that nobody is working on the machine or located within its working area.</li> <li>• Secure the machine's work area against unintended access.</li> <li>• Lower hanging/suspended loads to the floor.</li> </ul>

#### Preconditions

- You selected a method of motor data identification during quick commissioning, e.g. measurement of the motor data while the motor is stationary.



When quick commissioning is complete, the inverter issues alarm A07991.









- The motor has cooled down to the ambient temperature.

An excessively high motor temperature falsifies the motor data identification results.

**Procedure when using the BOP-2 operator panel**



To start the motor data identification, proceed as follows:

1.  ✓  Press the HAND/AUTO key.  
⇒ The BOP-2 displays the symbol for manual operation.
2.  Switch on the motor.
3.  During motor data identification, "MOT-ID" flashes on the BOP-2.
4.  If the inverter again outputs alarm A07991, then it waits for a new ON command to start the rotating measurement.  
If the inverter does not output alarm A07991, proceed to step 7.
5.  Switch on the motor to start the rotating measurement.
6.  During motor data identification, "MOT-ID" flashes on the BOP-2.  
The motor data identification can take up to 2 minutes depending on the rated motor power.
7.  Depending on the setting, after motor data identification has been completed, the inverter switches off the motor - or it accelerates it to the currently set setpoint.  
If required, switch off the motor.
8.  Switch the inverter control from HAND to AUTO.

 You have completed the motor data identification.

## 5.4 Quick commissioning with a PC.

The screen forms that are shown in this manual show generally valid examples. The number of setting options available in screen forms depends on the particular inverter type.

### Requirements

To be able to perform quick commissioning using a PC, you need to do the following:

1. Creating a project
2. Integrating the inverter into the project
3. Go online and start the quick commissioning

### 5.4.1 Creating a project

#### Creating a new project

##### Procedure



To create a new project, proceed as follows:

1. In the menu, select "Project" → "New...".
2. Specify a name of your choice for the project.



You have created a new project.

### 5.4.2 Transfer inverters connected via USB into the project

#### Integrating the inverter into the project

##### Procedure



Proceed as follows to transfer an inverter connected via USB to your project:

1. Switch on the inverter supply voltage.
2. First insert a USB cable into your PC and then into the inverter.
3. The PC operating system installs the USB driver when you are connecting the inverter and PC together for the first time.
  - Windows 7 installs the driver automatically.
  - For Windows XP you must acknowledge several system messages.
4. Start the commissioning software.

5. Press the "Accessible nodes" button.

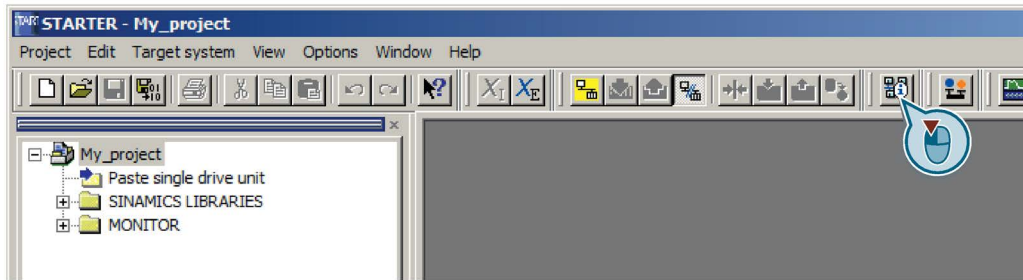

Image 5-4 "Accessible nodes" in STARTER

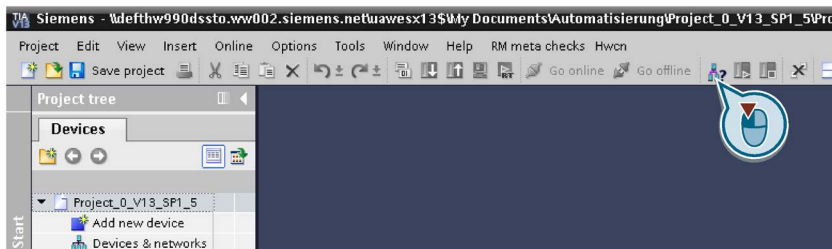

Image 5-5 "Accessible nodes" in Startdrive

6. When the USB interface is appropriately set, then the "Accessible nodes" screen form shows the inverters that can be accessed.

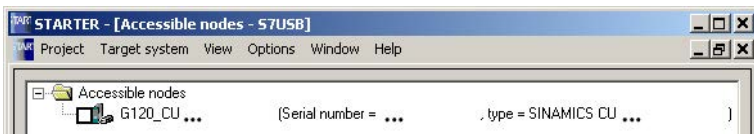

Image 5-6 Inverters found in STARTER

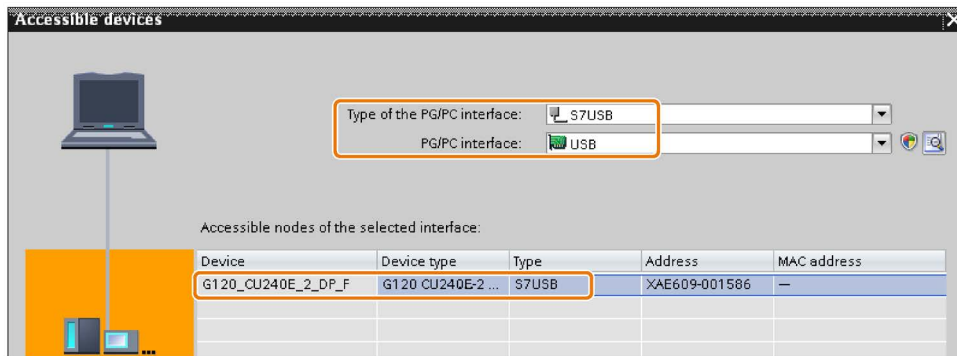

Image 5-7 Inverters found in Startdrive

If you have not correctly set the USB interface, then the following "No additional nodes found" message is displayed. In this case, follow the description below.



7. Proceed as follows:

With STARTER	With Startdrive
<ul style="list-style-type: none"> <li>Select the inverter <input checked="" type="checkbox"/>.</li> <li>Press the "Accept" button.</li> </ul>	Transfer the inverter into the project using the menu: "Online - Upload device as new station (hardware and software)".

- You have transferred an inverter accessible via the USB interface into your project.

## Setting the USB interface in STARTER

### Procedure



1 Proceed as follows to set the USB interface in STARTER:

1. Set the "Access point" to "DEVICE (STARTER, Scout)" and the "PG/PC interface" to "S7USB".
2. Press the "Update" button.

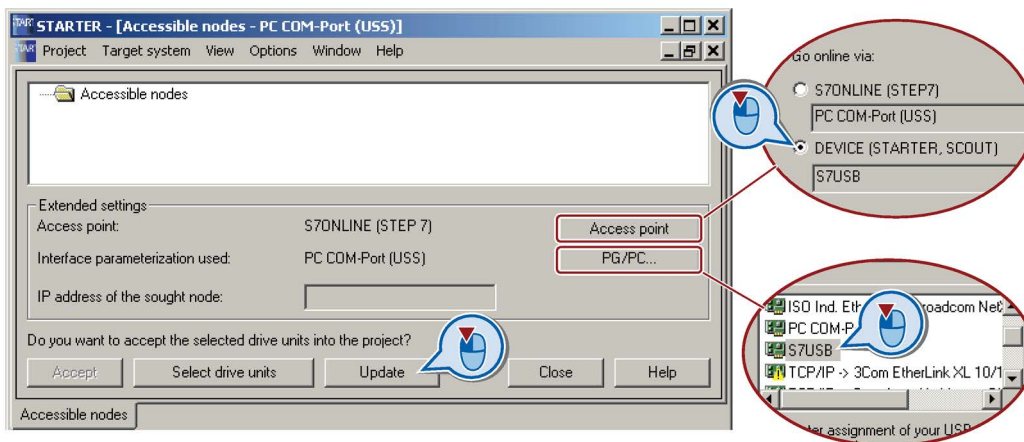

- You have set the USB interface.  
STARTER now shows the inverters connected via USB.

### 5.4.3 Go online and start quick commissioning

#### Procedure with STARTER



Proceed as follows to start the quick commissioning of the inverter:

1. Select your project and go online:
2. In the following screen form, select the inverter with which you wish to go online.
3. Download the hardware configuration found online in your project (PG or PC).

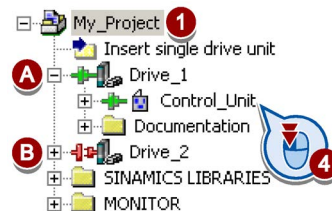

Significance of the symbol in front of the inverter:

(A) The inverter is online.

(B) The inverter is offline

4. When you are online, double-click on "Control Unit".
5. Start the commissioning wizard:

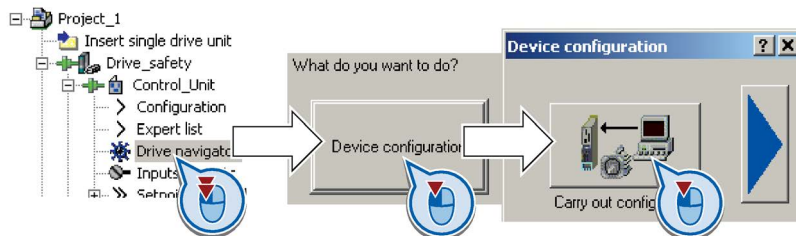

- You have started the quick commissioning of the inverter.

#### Procedure with Startdrive



Proceed as follows to start the quick commissioning of the inverter:

1. Select your project and go online:
2. In the following screen form, select the inverter with which you wish to go online.
3. Once you are online, select "Commissioning" → "Commissioning Wizard":

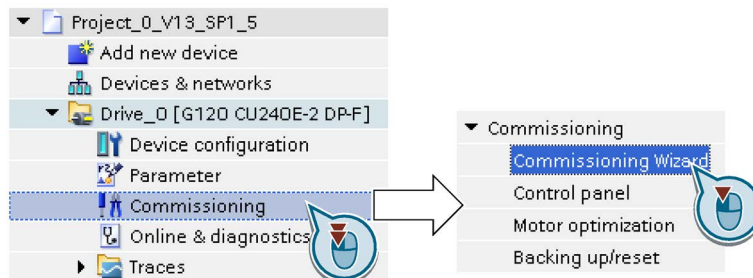

- You have started the quick commissioning of the inverter.

## 5.4.4 Carrying out quick commissioning

### 5.4.4.1 Overview

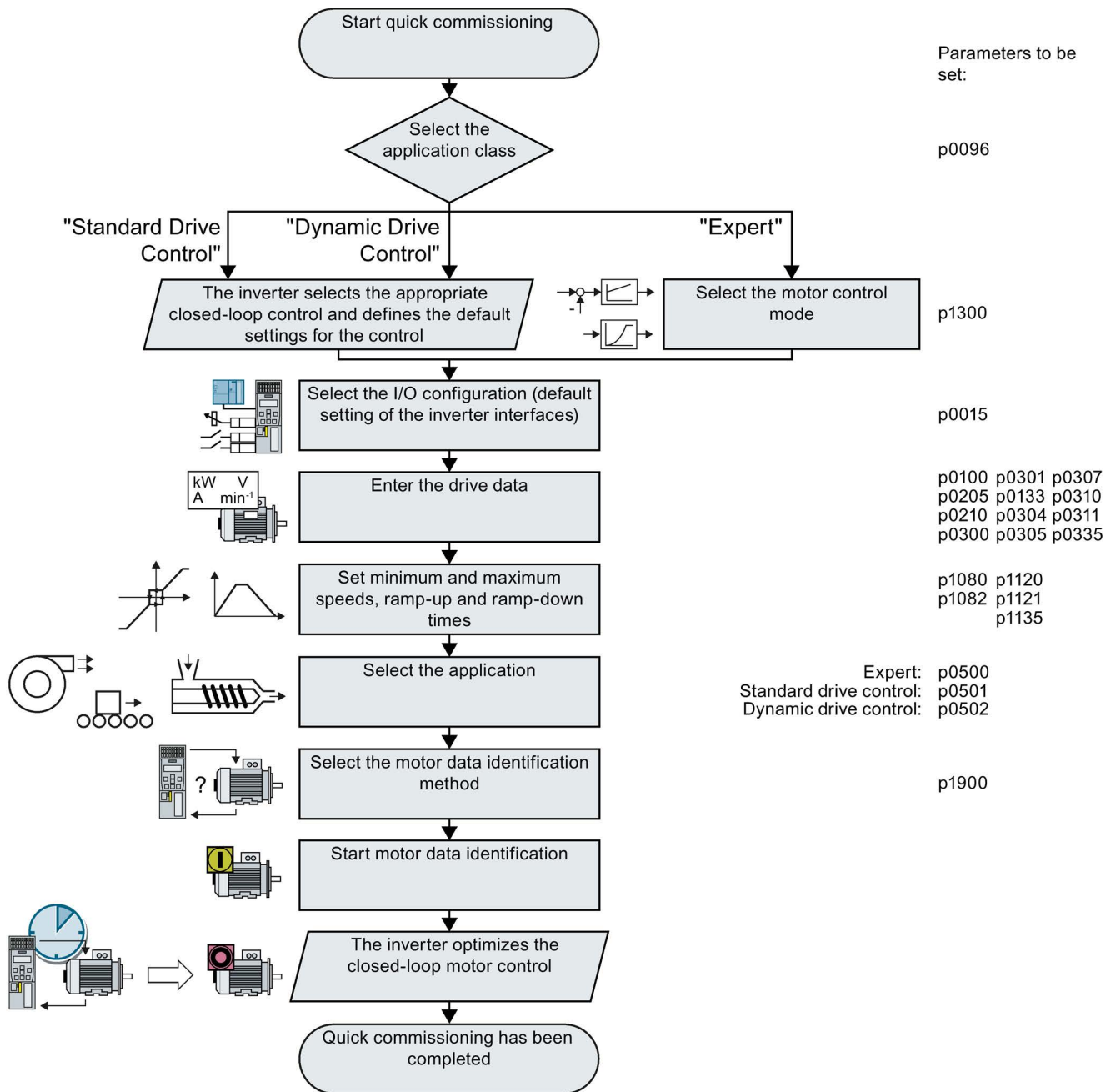

Image 5-8 Quick commissioning with a PC



**Procedure**



Proceed as follows to carry out quick commissioning:

1.  Application class

When selecting an application class, the inverter assigns the motor control with the appropriate default settings:

- [1]  Standard Drive Control (Page 154)
- [2]  Dynamic Drive Control (Page 155)
- [0] Expert - or if no application class is listed:  
 Expert (Page 156)

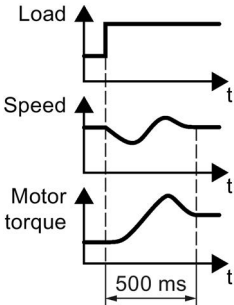
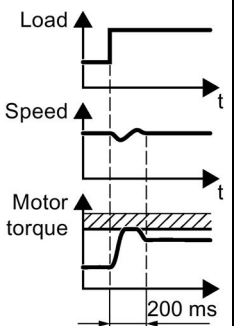

## Selecting a suitable application class

When selecting an application class, the inverter assigns the appropriate settings to the motor control.

Application class	Standard Drive Control	Dynamic Drive Control
<b>Motors that can be operated</b>	Induction motors	Induction and synchronous motors
<b>Power Modules that can be operated</b>	PM240, PM240-2, PM340	
<b>Application examples</b>	<ul style="list-style-type: none"> <li>• Pumps, fans, and compressors with flow characteristic</li> <li>• Wet or dry blasting technology</li> <li>• Mills, mixers, kneaders, crushers, agitators</li> <li>• Horizontal conveyor technology (conveyor belts, roller conveyors, chain conveyors)</li> <li>• Basic spindles</li> </ul>	<ul style="list-style-type: none"> <li>• Pumps and compressors with displacement machines</li> <li>• Rotary furnaces</li> <li>• Extruder</li> <li>• Centrifuge</li> </ul>
<b>Properties</b>	<ul style="list-style-type: none"> <li>• Typical correction time after a speed change: 100 ms ... 200 ms</li> <li>• Typical correction time after a load surge: 500 ms</li> <li>• Standard Drive Control is suitable for the following requirements: <ul style="list-style-type: none"> <li>– Motor power ratings &lt; 45 kW</li> <li>– Acceleration time 0 → rated speed (depending on the rated motor power): 1 s (0.1 kW) ... 10 s (45 kW)</li> <li>– Applications with increasing load torque without load surges</li> </ul> </li> <li>• Standard Drive Control is insensitive with respect to inaccurate motor data settings</li> </ul> 	<ul style="list-style-type: none"> <li>• Typical correction time after a speed change: &lt; 100 ms</li> <li>• Typical correction time after a load surge: 200 ms</li> <li>• Dynamic Drive Control controls and limits the motor torque</li> <li>• Torque accuracy that can be achieved: ± 5 % for 15 % ... 100 % of the rated speed</li> <li>• We recommend Dynamic Drive Control for the following applications: <ul style="list-style-type: none"> <li>– Motor power ratings &gt; 11 kW</li> <li>– For load surges of 10 % ... &gt;100 % of the rated motor torque</li> </ul> </li> <li>• Dynamic Drive Control is necessary for a ramp-up time 0 → rated speed (dependent on the rated motor power): &lt; 1 s (0.1 kW) ... &lt; 10 s (250 kW).</li> </ul> 
<b>Max. output frequency</b>	550 Hz	240 Hz
<b>Torque control</b>	Without torque control	Speed control with lower-level torque control
<b>Commissioning</b>	<ul style="list-style-type: none"> <li>• Contrary to "Dynamic Drive Control" a speed controller does not have to be set</li> <li>• In comparison to "Configuration for experts": <ul style="list-style-type: none"> <li>– Simplified commissioning using preassigned motor data</li> <li>– Reduced number of parameters</li> </ul> </li> </ul>	<ul style="list-style-type: none"> <li>• Reduced number of parameters when compared to "Configuration for experts"</li> </ul>

### 5.4.4.2 Standard Drive Control

#### Procedure for application class [1]: Standard Drive Control



2.  Defaults of the setpoint Select the I/O configuration to preassign the inverter interfaces.
  -  Default settings of the CU240B-2 interfaces (Page 97)
  -  Default settings of the CU240E-2 interfaces (Page 104)
3.  Drive setting Set the applicable motor standard and the inverter supply voltage.
4.  Motor Select your motor.
5.  Motor data Enter the motor data according to the rating plate of your motor. If you have selected a motor based on its article number, the data has already been entered.
6.  Important parameters Set the most important parameters to suit your application.
7.  Drive functions Select the application:
  - [0] Constant load: Typical applications include conveyor drives
  - [1] Speed-dependent load: Typical applications include pumps and fansMotor identification:
  - [1]: Recommended setting. Measure the motor data at standstill and with the motor rotating. The inverter switches off the motor after the motor data identification has been completed.
  - [2]: Measure the motor data at standstill. The inverter switches off the motor after the motor data identification has been completed.

Select this setting if the motor cannot freely rotate, e.g. for a mechanically limited traversing range.
  - [3]: Measure the motor data while it is rotating. The inverter switches off the motor after the motor data identification has been completed.
  - [11]: The same setting as [1]. The motor accelerates to the currently set setpoint after the motor data identification.
  - [12]: The same setting as [2]. The motor accelerates to the currently set setpoint after the motor data identification.

You have completed quick commissioning.

### 5.4.4.3 Dynamic Drive Control

#### Procedure for application class [2]: Dynamic Drive Control

2.  Defaults of the setpoint Select the I/O configuration to preassign the inverter interfaces.
  -  Default settings of the CU240B-2 interfaces (Page 97)
  -  Default settings of the CU240E-2 interfaces (Page 104)
3.  Drive setting Set the applicable motor standard and the inverter supply voltage.
4.  Motor Select your motor.
5.  Motor data Enter the motor data according to the rating plate of your motor. If you have selected a motor based on its article number, the data has already been entered.
6.  Important parameters Set the most important parameters to suit your application.
7.  Drive functions
 

Application:

  - [0]: Recommended setting for standard applications.
  - [1]: Recommended setting for applications with ramp-up and ramp-down times < 10 s. This setting is not suitable for hoisting gear and cranes.
  - [5] Recommended setting for applications with a high break loose torque.

Motor identification:



  - [1]: Recommended setting. Measure the motor data at standstill and with the motor rotating. The inverter switches off the motor after the motor data identification has been completed.
  - [2]: Measure the motor data at standstill. The inverter switches off the motor after the motor data identification has been completed.
 

Select this setting if the motor cannot freely rotate, e.g. for a mechanically limited traversing range.
  - [3]: Measure the motor data while it is rotating. The inverter switches off the motor after the motor data identification has been completed.
  - [11]: The same setting as [1]. The motor accelerates to the currently set setpoint after the motor data identification.
  - [12]: The same setting as [2]. The motor accelerates to the currently set setpoint after the motor data identification.

You have completed quick commissioning.

### 5.4.4.4 Expert

#### Procedure without application class or for the application class [0]: Expert

2.  Control structure Select the control mode.
3.  Defaults of the setpoint Select the I/O configuration to preassign the inverter interfaces.
  -  Default settings of the CU240B-2 interfaces (Page 97)
  -  Default settings of the CU240E-2 interfaces (Page 104)
4.  Drive setting Set the applicable motor standard and the inverter supply voltage.  
Application:
  - "[0] Load cycle with high overload for applications requiring a high dynamic performance, e.g. conveyor systems.
  - "[1] Load cycle with low overload ..." for applications that do not require a high dynamic performance, e.g. pumps or fans.
  - [6], [7]: Load cycles for applications with encoderless 1FK7 synchronous motors.
5.  Motor Select your motor.
6.  Motor data Enter the motor data according to the rating plate of your motor. If you have selected a motor based on its article number, the data has already been entered.
7.  Important parameters Set the most important parameters to suit your application.
8.  Drive functions Application:
  - [0]: In all applications that do not fall under [1] ... [3]
  - [1]: Applications involving pumps and fans
  - [2]: Applications with short ramp-up and ramp-down times. However, this setting is not suitable for hoisting gear and cranes/lifting gear.
  - [3]: Setting only for steady-state operation with slow speed changes. We recommend setting [1] if load surges in operation cannot be ruled out.



## Motor identification:

- [1]: Recommended setting. Measure the motor data at standstill and with the motor rotating. The inverter switches off the motor after the motor data identification has been completed.
- [2]: Measure the motor data at standstill. The inverter switches off the motor after the motor data identification has been completed.

## Recommended setting for the following cases:

- You have selected "Speed control" as control mode, however the motor cannot freely rotate, e.g. for mechanically limited traversing sections.
- You have set "V/f control" as control mode.
- [3]: Measure the motor data while it is rotating. The inverter switches off the motor after the motor data identification has been completed.
- [11]: The same setting as [1]. The motor accelerates to the currently set setpoint after the motor data identification.
- [12]: The same setting as [2]. The motor accelerates to the currently set setpoint after the motor data identification.

Calculating the motor parameters: Select "Complete calculation".

9. Set the check mark for "RAM to ROM (save data in the drive)" to save your data in the inverter so that it is not lost when the power fails.

Select "Finish".

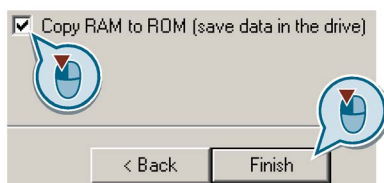

## Exiting quick commissioning in STARTER

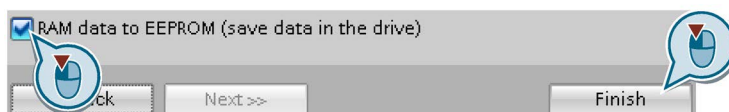

## Exiting quick commissioning in Startdrive

- You have completed quick commissioning.

Select a suitable control mode

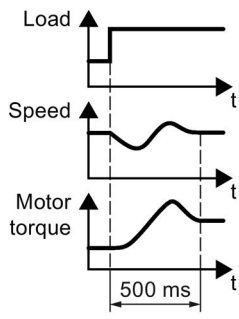
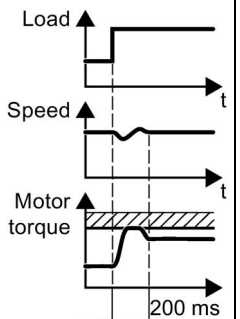
Control mode	U/f control or flux current control (FCC)	Sensorless vector control
Motors that can be operated	Induction motors	Induction and synchronous motors
Power Modules that can be operated	No restrictions	
Application examples	<ul style="list-style-type: none"> <li>Pumps, fans, and compressors with flow characteristic</li> <li>Wet or dry blasting technology</li> <li>Mills, mixers, kneaders, crushers, agitators</li> <li>Horizontal conveyor technology (conveyor belts, roller conveyors, chain conveyors)</li> <li>Basic spindles</li> </ul>	<ul style="list-style-type: none"> <li>Pumps and compressors with displacement machines</li> <li>Rotary furnaces</li> <li>Extruder</li> <li>Centrifuge</li> </ul>
Properties	<ul style="list-style-type: none"> <li>Typical correction time after a speed change: 100 ms ... 200 ms</li> <li>Typical correction time after a load surge: 500 ms</li> <li>The control mode is suitable to address the following requirements:                             <ul style="list-style-type: none"> <li>Motor power ratings &lt; 45 kW</li> <li>Ramp-up time 0 → Rated speed (dependent on the rated motor power): 1 s (0.1 kW) ... 10 s (45 kW)</li> <li>Applications with constant load torque without load surges</li> </ul> </li> <li>Die Regelungsart is insensitive with respect to imprecise setting of the motor data</li> </ul> 	<ul style="list-style-type: none"> <li>Typical correction time after a speed change: &lt; 100 ms</li> <li>Typical correction time after a load surge: 200 ms</li> <li>The control mode controls and limits the motor torque</li> <li>Torque accuracy that can be achieved: ± 5 % for 15 % ... 100 % of the rated speed</li> <li>We recommend the control mode for the following applications:                             <ul style="list-style-type: none"> <li>Motor power ratings &gt; 11 kW</li> <li>For load surges of 10 % ... &gt;100 % of the rated motor torque</li> </ul> </li> <li>The control mode is necessary for a ramp-up time 0 → Rated speed (dependent on the rated motor power): &lt; 1 s (0.1 kW) ... &lt; 10 s (250 kW).</li> </ul> 
Max. output frequency	550 Hz	240 Hz
Closed-loop torque control	Without torque control	Torque control with and without higher-level speed control
Commissioning	<ul style="list-style-type: none"> <li>Contrary to encoderless vector control, the speed controller does not have to be set</li> </ul>	

#### 5.4.4.5 Identify motor data

##### Identify motor data

 <b>WARNING</b>
<p><b>Danger to life from machine movements while motor data identification is in progress</b></p> <p>The stationary measurement can turn the motor a number of revolutions. The rotating measurement accelerates the motor up to the rated speed. Secure dangerous machine parts before starting motor data identification:</p> <ul style="list-style-type: none"><li>• Before switching on, ensure that nobody is working on the machine or located within its working area.</li><li>• Secure the machine's working area against unintended access.</li><li>• Lower suspended loads to the floor.</li></ul>

##### Preconditions

- You selected a method of motor data identification during quick commissioning, e.g. measurement of the motor data while the motor is stationary.

When quick commissioning is complete, the inverter issues alarm A07991.

- The motor has cooled down to the ambient temperature.

An excessively high motor temperature distorts the results of motor data identification.

**Procedure with STARTER**



To initiate motor data identification and optimize the motor control, proceed as follows:

1. Open the control panel.

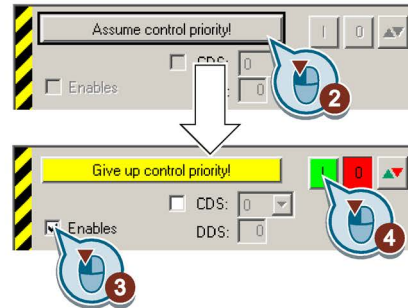
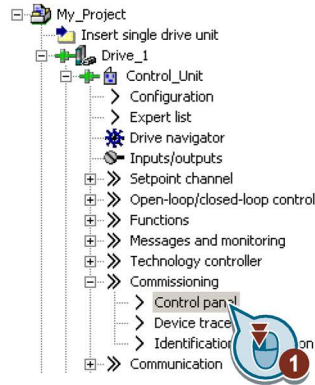



Image 5-9 Control panel

2. Assume master control for the inverter.
3. Set the "Enable signals"
4. Switch on the motor.

The inverter starts the motor data identification. This measurement can take several minutes.

Depending on the setting, after motor data identification has been completed, the inverter switches off the motor - or it accelerates it to the currently set setpoint.

5. If required, switch off the motor.
6. Relinquish the master control after the motor data identification.
7. Press button  (RAM to ROM).

- You have completed the motor data identification.

### Procedure with Startdrive

- ➔ 1 To initiate motor data identification and optimize the motor control, proceed as follows:  
2

1. Open the control panel.

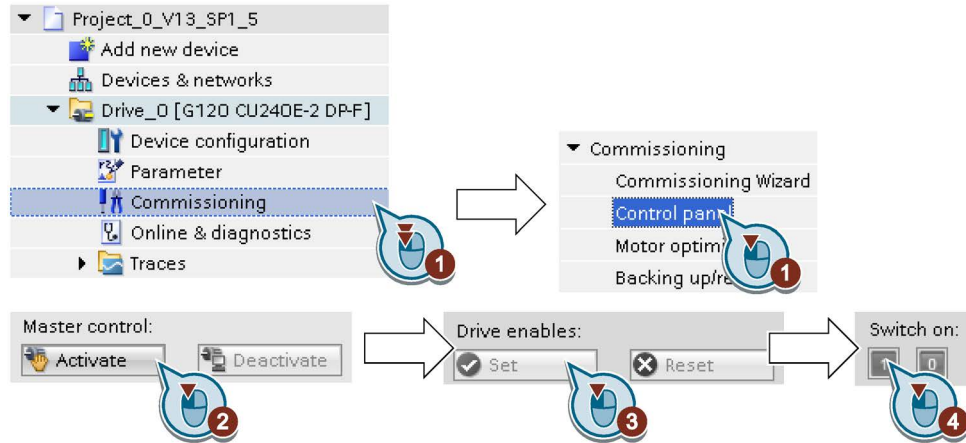

2. Assume master control for the inverter.
3. Set the "Drive enables"
4. Switch on the motor.

The inverter starts the motor data identification. This measurement can take several minutes.

Depending on the setting, after motor data identification has been completed, the inverter switches off the motor - or it accelerates it to the currently set setpoint.

5. If required, switch off the motor.
6. Relinquish the master control after the motor data identification.
7. Save the settings in the inverter (RAM → EEPROM):

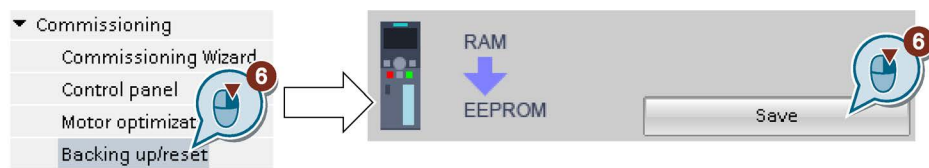

- You have completed the motor data identification.

### Self-optimization of the speed control

If you have selected not only motor data identification but also rotating measurement with self-optimization of the speed control, you must switch on the motor again as described above and wait for the optimization run to finish.

## 5.5 Restoring the factory setting

There are cases where something goes wrong when commissioning a drive system e.g.:

- The line voltage was interrupted during commissioning and you were not able to complete commissioning.
- You got confused during the commissioning and you can no longer understand the individual settings that you made.
- You do not know whether the inverter was already operational.

In cases such as these, reset the inverter to the factory setting.

### Restoring the factory settings when the safety functions are enabled

If you are using the integrated safety functions of the inverter, e.g. "Safe Torque Off", you must reset the safety functions separately from the remaining inverter settings.

The settings of the safety functions are protected by a password.

### Settings that are not changed when restoring the factory setting

The communication settings and the settings of the motor standard (IEC/NEMA) are kept when restoring the factory setting.

## 5.5.1 Resetting the safety functions to the factory setting

### Procedure with STARTER

- ➔ 1 To reset the safety function settings to the factory setting without changing the standard settings, proceed as follows:
- ➔ 2
1. Go online.
  2. Open the screen form of the safety functions.
  3. Select the button to restore the factory settings.



4. Enter the password for the safety functions.
  5. Confirm that the parameters have been saved (RAM to ROM).
  6. Go offline.
  7. Switch off the inverter supply voltage.
  8. Wait until all LEDs on the inverter go dark.
  9. Switch on the inverter supply voltage again.
- You have restored the safety functions in the inverter to the factory settings.

Exception: The password for the safety functions is not reset.

➔ Safety functions password (Page 330)

**Procedure with Startdrive**



To reset the safety function settings to the factory setting without changing the standard settings, proceed as follows:

1. Go online.

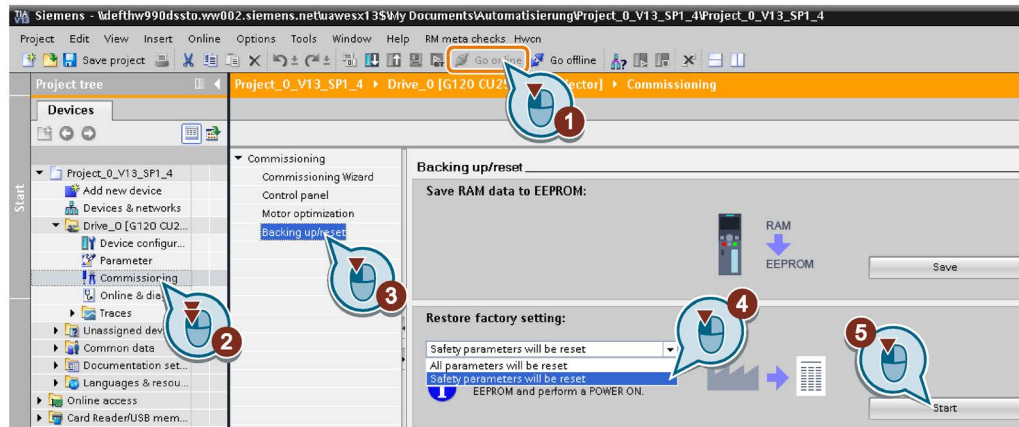

2. Select "Commissioning".
  3. Select "Backing up/reset".
  4. Select "Safety parameters are reset".
  5. Press the "Start" button.
  6. Enter the password for the safety functions.
  7. Confirm that the parameters have been saved (RAM to ROM).
  8. Go offline.
  9. Switch off the inverter supply voltage.
  10. Wait until all LEDs on the inverter go dark.
  11. Switch on the inverter supply voltage again.
- You have restored the safety functions in the inverter to the factory settings.

Exception: The password for the safety functions is not reset.

Safety functions password (Page 330)





### Procedure with an operator panel

Proceed as follows to restore the inverter safety functions to the factory settings:

1. p0010 = 30Set  
Activate reset settings.
2. p9761 = ...  
Enter the password for the safety functions
3. Start the reset with p0970 = 5.
4. Wait until the inverter sets p0970 = 0.
5. Set p0971 = 1.
6. Wait until the inverter sets p0971 = 0.
7. Switch off the inverter supply voltage.
8. Wait until all LEDs on the inverter go dark.
9. Switch on the inverter supply voltage again.

You have restored the safety function settings of your inverter to the factory settings.

### 5.5.2 Restore the factory settings (without safety functions)

#### Restore the factory inverter settings

##### Procedure with STARTER

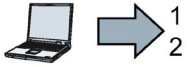

Proceed as follows to reset the inverter to factory settings:

1. Select your drive.
2. Go online.
3. Open "Drive Navigator".

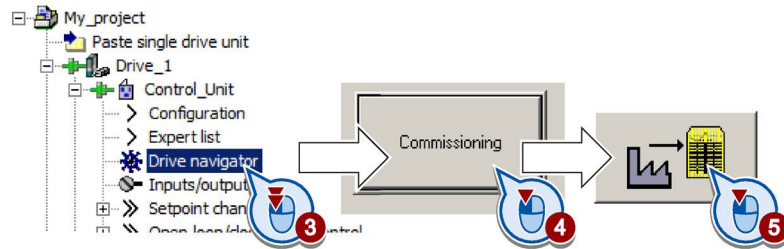

4. Select the "Commissioning" button.
5. Press the "Factory setting" button.
6.  In the screen form, select "After loading copy RAM to ROM".
7. Start the reset.
8. Wait until the inverter has been reset to the factory setting.

You have reset the inverter to factory settings.

### Procedure with Startdrive



1  
2

Proceed as follows to reset the inverter to factory settings:

1. Go online.
2. Select "Commissioning".
3. Select "Backing up/reset".
4. Select "All parameters are reset".
5. Press the "Start" button.

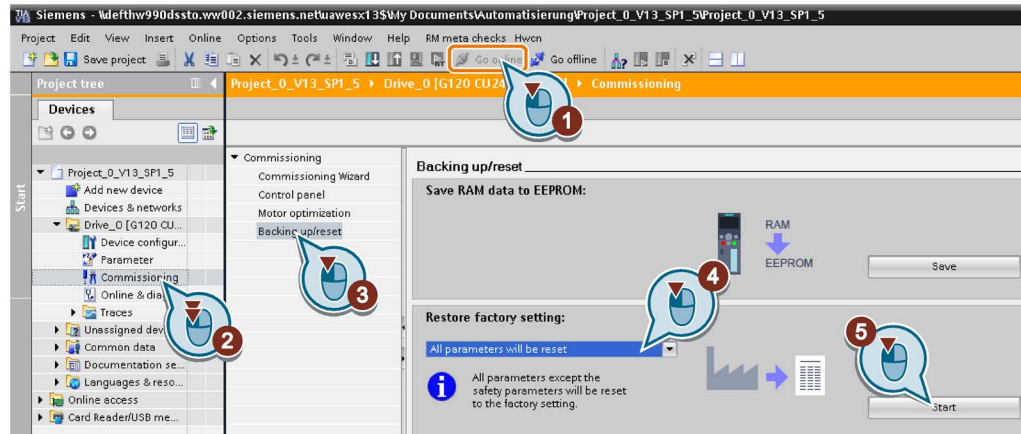

6. Wait until the inverter has been reset to the factory setting.

- You have reset the inverter to factory settings.

### Procedure with the BOP-2 operator panel



1  
2

Proceed as follows to reset the inverter to factory settings:

1. In the "Options" menu, select the "DRVRESET" entry
2. Confirm the reset using the OK key.
3. Wait until the inverter has been reset to the factory setting.

- You have reset the inverter to factory settings.



## Advanced commissioning

### 6.1 Overview of the inverter functions

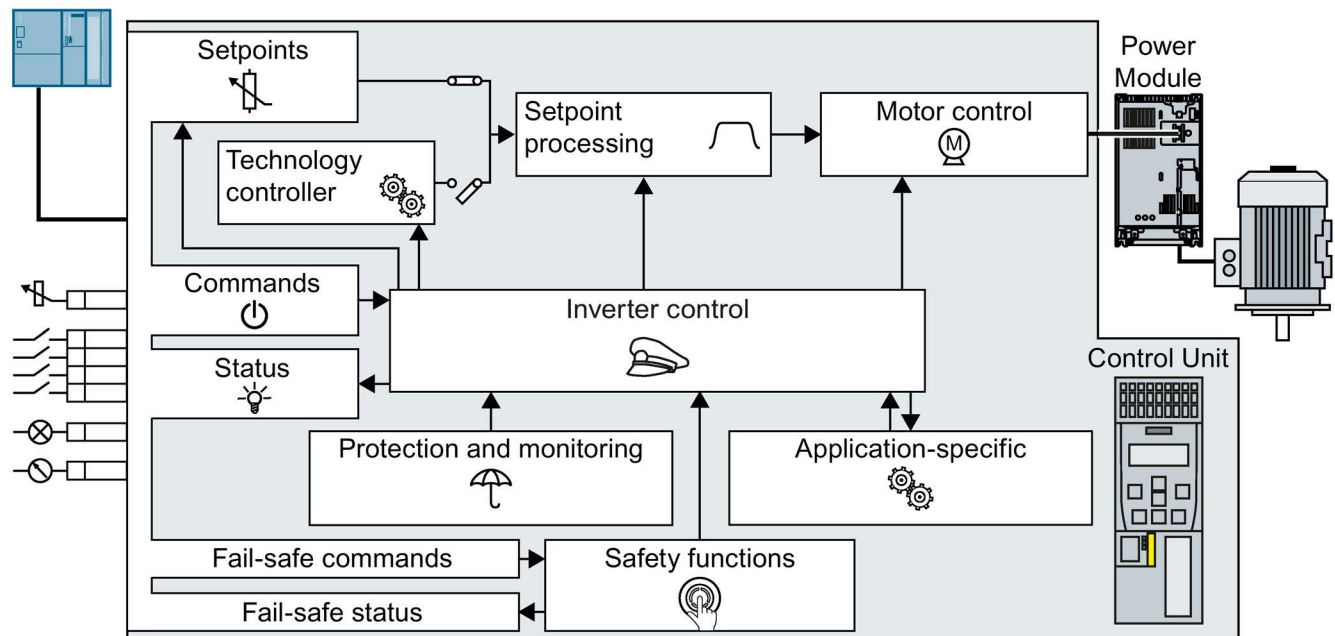











Image 6-1 Overview of inverter functions

- 
**Inverter control** is responsible for all of the other inverter functions. Among other things, it defines how the inverter responds to commands from the higher-level control system.
  -  Inverter control (Page 171)
- 
 The **commands** from the higher-level control are sent to the inverter via digital inputs or the fieldbus. The inverter returns its **status signals** to the outputs of the Control Unit or to the fieldbus.
  -  Adapt the default setting of the terminal strip (Page 173)
  -  Connecting the inverter to the fieldbus (Page 118)
- 
 You must define a **setpoint**, which defines the motor speed, for example.
  -  Setpoints (Page 219)
- 
 The **setpoint processing** uses a ramp-function generator to prevent speed steps occurring and to limit the speed to a permissible maximum value.
  -  Setpoint calculation (Page 227)



The **motor closed-loop control** ensures that the motor follows the speed setpoint. You can select either vector control or V/f control.



Motor control (Page 237)



The **protection and monitoring** functions prevent damage to the motor, inverter and driven load, e.g. by monitoring the temperature or torque.



Protection functions (Page 262)



The **application-specific** functions control, for example, a motor holding brake – or permit a higher-level closed-loop pressure or temperature control to be implemented using the technology controller.



Application-specific functions (Page 276)



The **safety functions** fulfill increased requirements regarding the functional safety of the drive.



Safe Torque Off (STO) safety function (Page 327)

The extended safety functions monitor the drive speed.

The extended safety functions are described in the "Safety Integrated" function manual.



Overview of the manuals (Page 507)

## 6.2 Inverter control

### 6.2.1 Switching the motor on and off



After switching the supply voltage on, the converter normally goes into the "ready to start" state. In this state, the converter waits for the command to switch-on the motor:

- The converter switches on the motor with the ON command. The converter changes to the "Operation" state.
- The converter brakes the motor after the OFF1 command. The converter switches off the motor once standstill has been reached. The converter is again "ready to start".

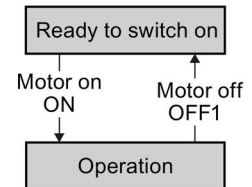

### Converter states and commands for switching the motor on and off

With the exception of ON/OFF1, "Ready to switch on" and "Ready" there are no additional inverter states and commands to switch on and switch off the motor:

- OFF2 - the converter immediately switches off the motor without first braking it.
- OFF3 - this command means "quick stop". After OFF3, the converter brakes the motor with the OFF3 ramp-down time. After reaching standstill, the converter switches off the motor.  
The command is frequently used for exceptional operating situations where it is necessary to brake the motor especially quickly. Collision protection is a typical application for this function.
- Block operation - The inverter switches the motor off.
- Enable operation - The inverter switches the motor on.

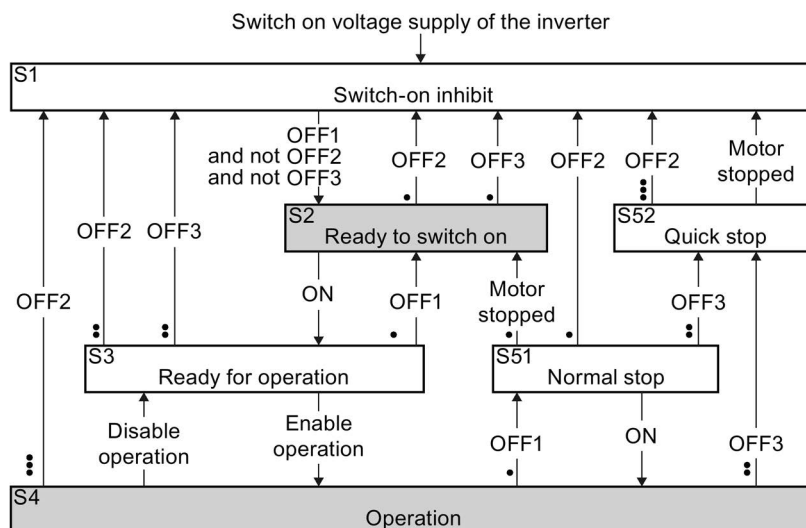

Image 6-2 Internal sequence control of the converter when the motor is switched on and off

The abbreviations S1 ... S5b to identify the converter states are defined in the PROFIdrive profile.

Converter status	Explanation
S1	In this state, the converter does not respond to the ON command. The converter goes into this state under the following conditions: <ul style="list-style-type: none"> <li>• ON was active when switching on the converter. Exception: When the automatic start function is active, ON must be active after switching on the power supply.</li> <li>• OFF2 or OFF3 is selected.</li> </ul>
S2	This state is required to switch on the motor.
S3	The converter waits for the operating enable.
S4	The motor is switched on.
S51	The motor was switched off with OFF1 and brakes with the ramp-down time of the ramp-function generator.
S52	The motor was switched off with OFF3 and brakes with the OFF3 ramp-down time, or at the current limit.



## 6.2.2 Adapt the default setting of the terminal strip

This chapter describes how you adapt the function of individual digital and analog inputs and outputs of the inverter.

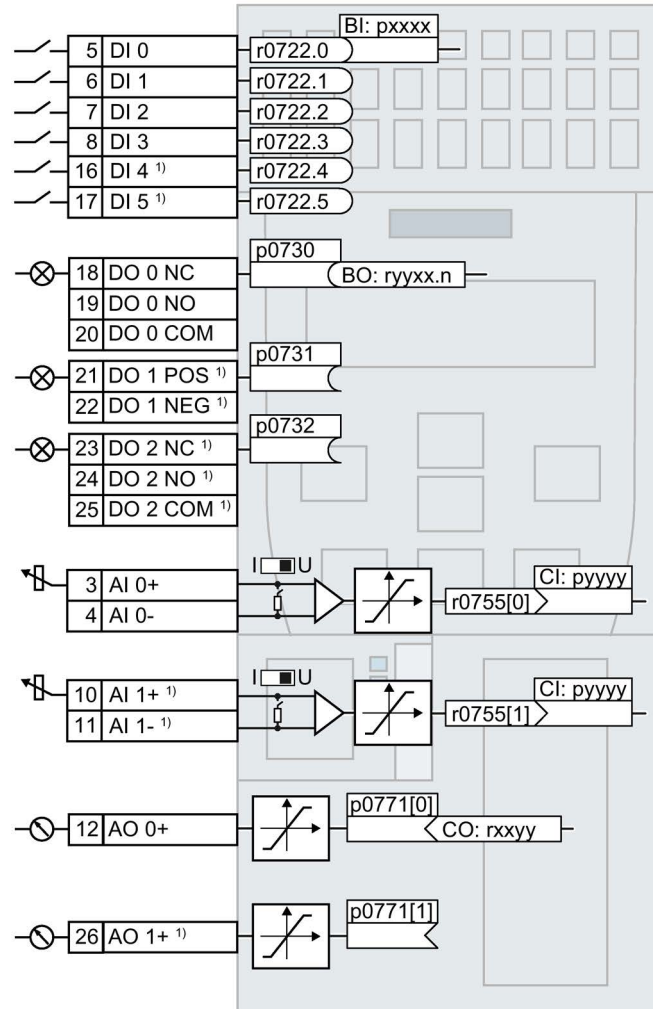

<sup>1)</sup> Not available with Control Units CU240B-2 and CU240B-2 DP

Image 6-3 Internal interconnection of the inputs and outputs

### 6.2.2.1 Digital inputs

#### Changing the function of a digital input

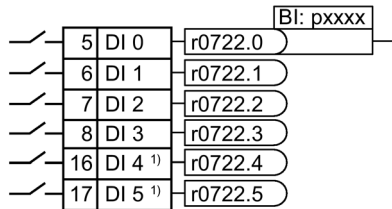

To change the function of a digital input, you must interconnect the status parameter of the digital input with a binector input of your choice.

 Interconnecting signals in the inverter (Page 495)  
Binector inputs are marked with "BI" in the parameter list of the List Manual.

<sup>1)</sup>Not available with Control Units CU240B-2 and CU240B-2 DP

Table 6- 1 Binector inputs (BI) of the inverter (selection)

BI	Significance	BI	Significance
p0810	Command data set selection CDS bit 0	p1036	Motorized potentiometer, setpoint, lower
p0840	ON/OFF1	p1055	Jog bit 0
p0844	OFF2	p1056	Jog bit 1
p0848	OFF3	p1113	Setpoint inversion
p0852	Enable operation	p1201	Flying restart enable signal source
p0855	Unconditionally release holding brake	p2103	1. Acknowledge faults
p0856	Enable speed controller	p2106	External fault 1
p0858	Unconditionally close holding brake	p2112	External alarm 1
p1020	Fixed speed setpoint selection bit 0	p2200	Technology controller enable
p1021	Fixed speed setpoint selection bit 1	p3330	Two/three-wire control, control command 1
p1022	Fixed speed setpoint selection bit 2	p3331	Two/three-wire control, control command 2
p1023	Fixed speed setpoint selection bit 3	p3332	Two/three-wire control, control command 3
p1035	Motorized potentiometer, setpoint, raise		

A complete list of the binector outputs is provided in the List Manual.

#### Changing the function of a digital input - Example

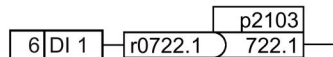

To acknowledge fault messages of the inverter using digital input DI 1, you must interconnect DI1 with the command to acknowledge faults (p2103): Set p2103 = 722.1.

#### Advanced settings

You can debounce the digital input signal using parameter p0724.

For more information, please see the parameter list and the function block diagrams 2220 f of the List Manual.

## Analog inputs as digital inputs

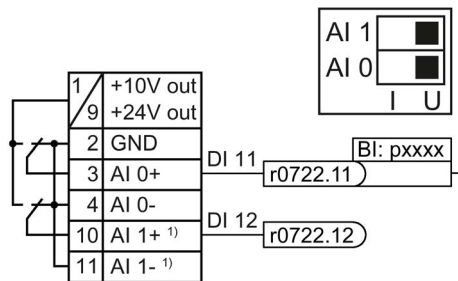

To use an analog input as additional digital input, you must interconnect the corresponding status parameter r0722.11 or r0722.12 with a binector input of your choice.

You may operate the analog input as digital input with 10 V or with 24 V.

<sup>1</sup> Not available with CU240B-2 and CU240B-2 DP Control Units

### NOTICE

#### Destruction of the analog input as a result of the excessively high input current

The 10 V or 24 V voltage source will destroy the analog input if the operating mode selector switch is set to "Current input" (I).

- Set the operating mode selector switch of the analog input to voltage (U).

### 6.2.2.2 Safety-related input

This manual describes the STO safety function with control via a safety-related input. All other safety functions, additional safety-related inputs of the inverter and the control of the safety functions via PROFIsafe are described in the Safety Integrated function manual.

#### Defining the safety-related input

If you use the STO safety function, then you must configure the terminal strip during the quick commissioning for a safety-related input, e.g. with p0015 = 2.

 Terminal strips on CU240E-2 Control Units (Page 100)

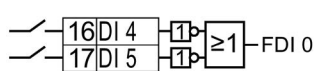

The inverter combines digital inputs DI 4 and DI 5 to create a safety-related input.

 Safe Torque Off (STO) safety function (Page 327)

---

#### Note

Control Units CU240B-2 and CU240B-2 DP do not have a safety-relevant digital input.

---

### 6.2.2.3 Digital outputs

#### Changing the function of a digital output

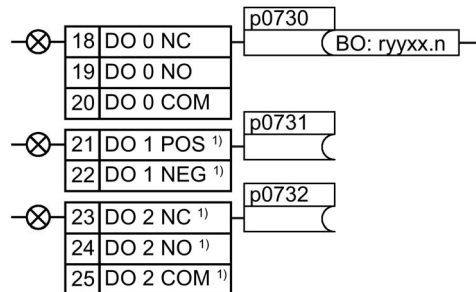

To change the function of a digital output, you must interconnect the digital output with a binector output of your choice.

 Interconnecting signals in the inverter  
(Page 495)

Binector outputs are marked with "BO" in the parameter list of the List Manual.

<sup>1)</sup>Not available with Control Units CU240B-2 and CU240B-2 DP

Table 6- 2 Binector outputs (BO) of the inverter (selection)

0	Deactivating digital output	r0052.9	Process data control
r0052.0	Drive ready	r0052.10	f_actual >= p1082 (f_max)
r0052.1	Drive ready for operation	r0052.11	Alarm: Motor current/torque limit
r0052.2	Drive running	r0052.12	Brake active
r0052.3	Drive fault active	r0052.13	Motor overload
r0052.4	OFF2 active	r0052.14	Motor CW rotation
r0052.5	OFF3 active	r0052.15	Inverter overload
r0052.6	Closing lockout active	r0053.0	DC braking active
r0052.7	Drive alarm active	r0053.2	f_actual > p1080 (f_min)
r0052.8	Setpoint/actual value discrepancy	r0053.6	f_actual ≥ setpoint (f_setpoint)

The complete list of binector outputs is provided in the List Manual.

#### Changing the function of a digital output - Example

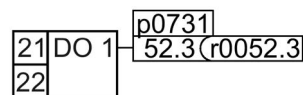

To output inverter fault messages via digital output DO 1, you must interconnect DO1 with the fault messages: Set p0731 = 52.3.

#### Advanced settings

You can invert the signal of the digital output using parameter p0748.

For more information, please see the parameter list and the function block diagrams 2230 f of the List Manual.

### 6.2.2.4 Analog inputs

#### Overview

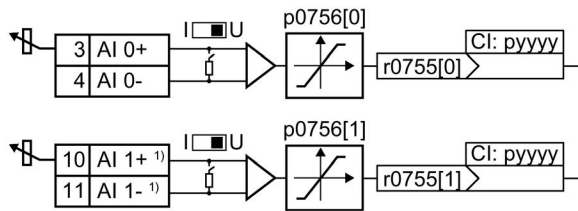

<sup>1)</sup>Not available with Control Units CU240B-2 and CU240B-2 DP

Changing the function of an analog input:

1. Define the analog input type using parameter p0756[x] and the switch on the inverter.
2. Define the function of the analog input by interconnecting parameter p0755[x] with a connector input CI of your choice.

 Interconnecting signals in the inverter (Page 495)

#### Define the analog input type

The variable speed drive offers a series of default settings, which you can select using parameter p0756:

AI 0	Unipolar voltage input	0 V ... +10 V	p0756[0] =	0
	Unipolar voltage input monitored	+2 V ... +10 V		1
	Unipolar current input	0 mA ... +20 mA		2
	Unipolar current input monitored	+4 mA ... +20 mA		3
	Bipolar voltage input	-10 V ... +10 V		4
	No sensor connected			8
	AI 1	Unipolar voltage input		0 V ... +10 V
Unipolar voltage input monitored		+2 V ... +10 V	1	
Unipolar current input		0 mA ... +20 mA	2	
Unipolar current input monitored		+4 mA ... +20 mA	3	
Bipolar voltage input		-10 V ... +10 V	4	
No sensor connected			8	

In addition, you must also set the switch associated with the analog input. You can find the switch on the Control Unit behind the lower front door.

- Voltage input: Switch position U (factory setting)
- Current input: Switch position I

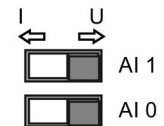

## Characteristics

If you change the analog input type using p0756, then the inverter automatically selects the appropriate scaling of the analog input. The linear scaling characteristic is defined using two points (p0757, p0758) and (p0759, p0760). Parameters p0757 ... p0760 are assigned to an analog input via their index, e.g. parameters p0757[0] ... p0760[0] belong to analog input 0.

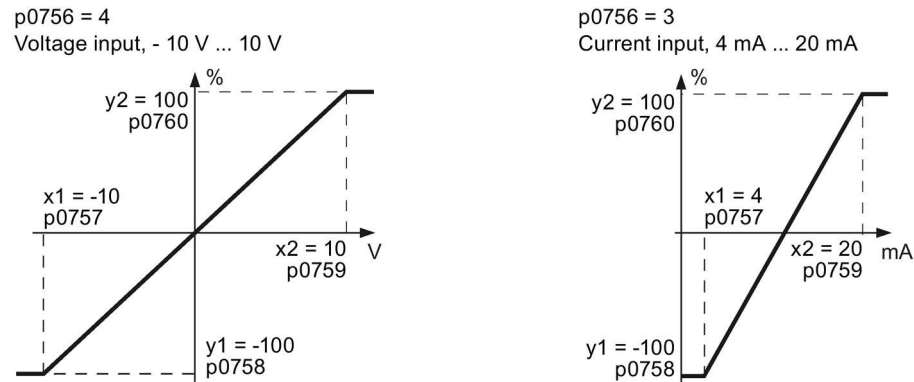

Image 6-4 Examples for scaling characteristics

Parameter	Description
p0757	x coordinate of the 1st Characteristic point [V or mA]
p0758	y coordinate of the 1st Characteristic point [% of p200x] p200x are the parameters of reference variables, e.g. p2000 is the reference speed
p0759	x coordinate of the 2nd Characteristic point [V or mA]
p0760	y coordinate of the 2nd Characteristic point [% of p200x]
p0761	Wire breakage monitoring response threshold

## Adapting the characteristic

You must define your own characteristic if none of the default types match your particular application.

### Example

The inverter should convert a 6 mA ... 12 mA signal into the value range -100 % ... 100 % via analog input 0. The wire break monitoring of the inverter should respond when 6 mA is fallen below.

### Precondition

You have set analog input 0 as a current input ("I") via the DIP switch on the Control Unit.



**Procedure**

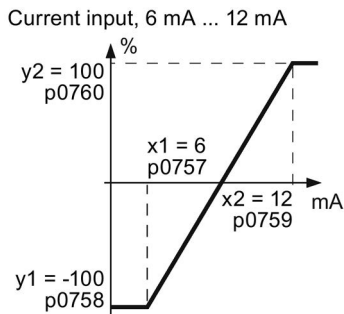

Set the following parameters to set the analog input as current input with monitoring:

1. Set p0756[0] = 3  
This means that you define analog input 0 as current input with wire breakage monitoring.
2. Set p0757[0] = 6.0 (x1)
3. Set p0758[0] = -100.0 (y1)
4. Set p0759[0] = 12.0 (x2)
5. Set p0760[0] = 100.0 (y2)

**Defining the function of an analog input**

You define the analog input function by interconnecting a connector input of your choice with parameter p0755. Parameter p0755 is assigned to the particular analog input based on its index, e.g. parameter p0755[0] is assigned to analog input 0.

Table 6- 3 Connector inputs (CI) of the inverter (selection)

CI	Significance	CI	Significance
p1070	Main setpoint	p1522	Torque limit, upper
p1075	Supplementary setpoint	p2253	Technology controller setpoint 1
p1503	Torque setpoint	p2264	Technology controller actual value
p1511	Supplementary torque 1		

A complete list of the connector inputs is provided in the List Manual.

**Defining the function of an analog input - example**

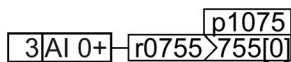

To enter a supplementary setpoint via analog input AI 0, you must interconnect AI 0 with the signal source for the supplementary setpoint:

Set p1075 = 755[0].

**Advanced settings**

**Signal smoothing**

When required, you can smooth the signal, which you read-in via an analog input, using parameter p0753.

For more information, see the parameter list and in the function block diagrams 9566 ff of the List Manual.



## Skip frequency band

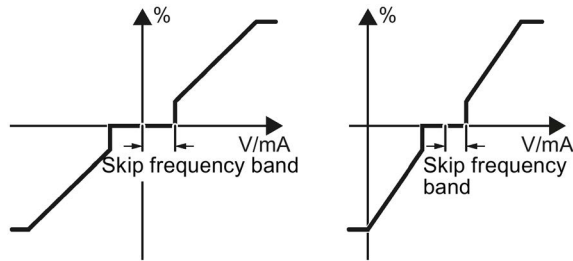

Interferences in the cable can corrupt small signals of a few millivolts. To be able to enter a setpoint of exactly 0 V via an analog input, you must specify a skip frequency band.

Skip frequency band of the analog input

p0764[0]	<b>Skip frequency band of the analog input AI 0</b> (factory setting: 0)
p0764[1]	<b>Skip frequency band of the analog input AI 1</b> (factory setting: 0)

## Using an analog input as digital input

An analog input can also be used as digital input.



Digital inputs (Page 174)

6.2.2.5 Analog outputs

Overview

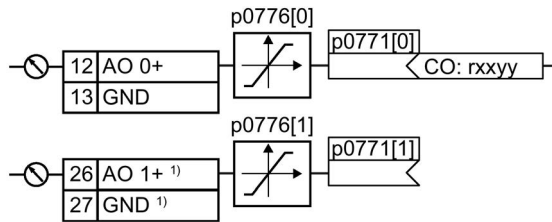

<sup>1)</sup>Not available with Control Units CU240B-2 and CU240B-2 DP

Changing the function of an analog output:

1. Define the analog output type using parameter p0776.
2. Interconnect parameter p0771 with a connector output of your choice.



Interconnecting signals in the inverter (Page 495)

Connector outputs are marked with "CO" in the parameter list of the List Manual.

Defining the analog output type

The inverter offers a series of default settings, which you can select using parameter p0776:

AO 0	Current output (factory setting)	0 mA ... +20 mA	p0776[0] =	0
	Voltage output	0 V ... +10 V		1
	Current output	+4 mA ... +20 mA		2
AO 1	Current output (factory setting)	0 mA ... +20 mA	p0776[1] =	0
	Voltage output	0 V ... +10 V		1
	Current output	+4 mA ... +20 mA		2

Characteristics

If you change the analog output type, then the inverter automatically selects the appropriate scaling of the analog output. The linear scaling characteristic is defined using two points (p0777, p0778) and (p0779, p0780).

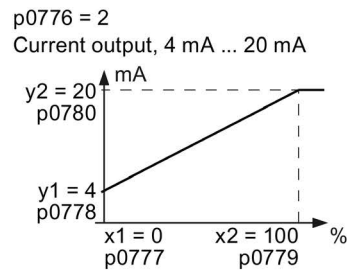
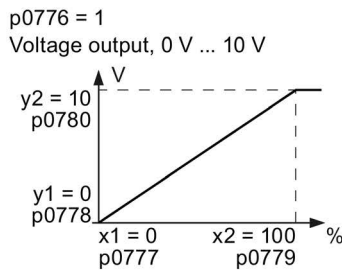

Image 6-5 Examples for scaling characteristics

Parameters p0777 ... p0780 are assigned to an analog output via their index, e.g. parameters p0777[0] ... p0770[0] belong to analog output 0.

Table 6- 4 Parameters for the scaling characteristic

Parameter	Description
p0777	<b>x coordinate of the 1st Characteristic point [% of p200x]</b> p200x are the parameters of the reference variables, e.g. p2000 is the reference speed.
p0778	<b>y coordinate of the 1st Characteristic point [V or mA]</b>
p0779	<b>x coordinate of the 2nd Characteristic point [% of p200x]</b>
p0780	<b>y coordinate of the 2nd Characteristic point [V or mA]</b>

## Setting the characteristic

You must define your own characteristic if none of the default types match your particular application.

### Example:

Via analog output 0, the inverter should convert a signal in the value range 0 % ... 100 % into an output signal 6 mA ... 12 mA.

### Procedure

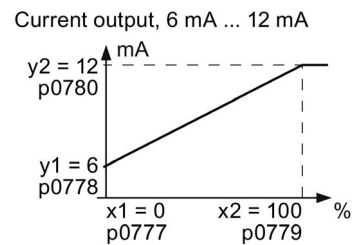

Set the following parameters to set the characteristic to match the example:

1. Set p0776[0] = 2  
This defines analog output 0 as a current output.
2. Set p0777[0] = 0.0 (x1)
3. Set p0778[0] = 6.0 (y1)
4. Set p0779[0] = 100.0 (x2)
5. Set p0780[0] = 12.0 (y2)

## Defining the function of an analog output

You define the analog output function by interconnecting parameter p0771 with a connector output of your choice. Parameter p0771 is assigned to the particular analog output via its index, e.g. parameter p0771[0] is assigned to analog output 0.

Table 6- 5 Connector outputs (CO) of the inverter (selection)

CO	Meaning	CO	Meaning
r0021	Actual frequency	r0026	Actual DC-link voltage
r0024	Output actual frequency	r0027	Output current
r0025	Output actual frequency		

A complete list of the connector outputs is provided in the List Manual.

For more information, please see the parameter list and the function block diagrams 2261 of the List Manual.

### Defining the function of an analog output - example

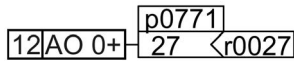

To output the inverter output current via analog output 0, you must interconnect AO 0 with the signal for the output current: Set p0771 = 27.

### Advanced settings

You can manipulate the signal that you output via an analog output, as follows:

- Absolute-value generation of the signal (p0775)
- Signal inversion (p0782)

Additional information is provided in the parameter list of the List Manual.

### 6.2.3 Inverter control using digital inputs

Five different methods are available for controlling the motor via digital inputs.

Table 6- 6 Two-wire control and three-wire control

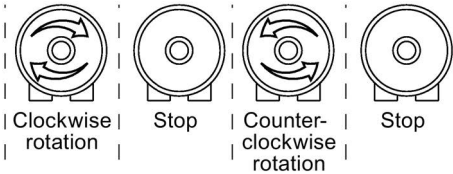
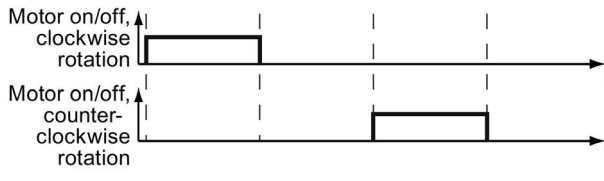
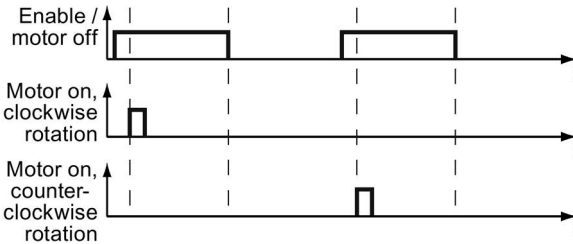
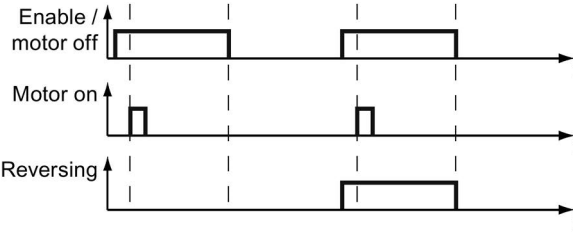
Behavior of the motor	Control commands	Typical application
 <p>Clockwise rotation   Stop   Counter-clockwise rotation   Stop</p>	<p><b>Two-wire control, method 1</b></p> <ol style="list-style-type: none"> <li>1. Switching the motor on and off (ON/OFF1).</li> <li>2. Reverse the motor direction of rotation.</li> </ol>	<p>Local control in conveyor systems.</p>
 <p>Motor on/off, clockwise rotation</p> <p>Motor on/off, counter-clockwise rotation</p>	<p><b>Two-wire control, method 2 and two-wire control, method 3</b></p> <ol style="list-style-type: none"> <li>1. Switch the motor on and off (ON/OFF1), clockwise rotation.</li> <li>2. Switch the motor on and off (ON/OFF1), counter-clockwise rotation.</li> </ol>	<p>Traction drives with control via joystick</p>
 <p>Enable / motor off</p> <p>Motor on, clockwise rotation</p> <p>Motor on, counter-clockwise rotation</p>	<p><b>Three-wire control, method 1</b></p> <ol style="list-style-type: none"> <li>1. Enable signal for switching the motor on and off (OFF1).</li> <li>2. Switch on the motor (ON), clockwise rotation.</li> <li>3. Switch on the motor (ON), counter-clockwise rotation.</li> </ol>	<p>Traction drives with control via joystick</p>
 <p>Enable / motor off</p> <p>Motor on</p> <p>Reversing</p>	<p><b>Three-wire control, method 2</b></p> <ol style="list-style-type: none"> <li>1. Enable signal for switching the motor on and off (OFF1).</li> <li>2. Switch on motor (ON).</li> <li>3. Reverse the motor direction of rotation.</li> </ol>	<p>-</p>

### 6.2.4 Two-wire control: method 1

You switch the motor on and off using a control command (ON/OFF1) while the other control command reverses the motor direction of rotation.

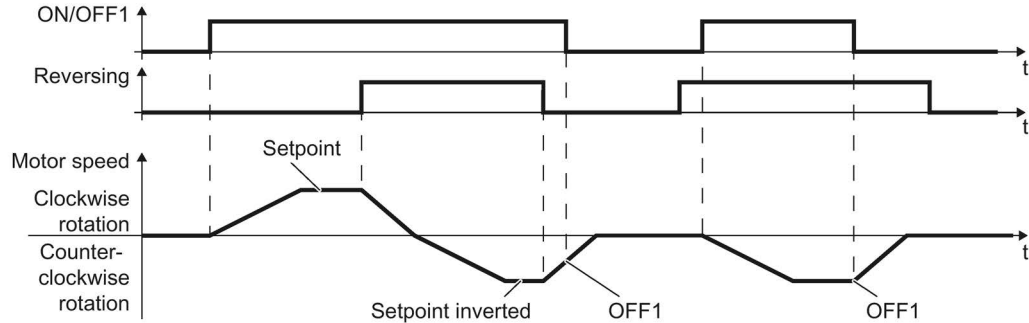

Image 6-6 Two-wire control, method 1

Table 6-7 Function table

ON/OFF1	Reversing	Function
0	0	OFF1: The motor stops.
0	1	OFF1: The motor stops.
1	0	ON: Clockwise motor rotation.
1	1	ON: Counter-clockwise motor rotation.

Parameter	Description		
p0015 = 12	<b>Macro drive unit</b>		
	Controlling the motor using the digital inputs of the inverter:	DI 0 ON/OFF1	DI 1 Reversing
<b>Advanced setting</b> Interconnecting control commands with digital inputs of your choice.			
p0840[0 ... n] = 722.x	<b>BI: ON/OFF1</b> (ON/OFF1) Example: p0840[0] = 722.3 ⇒ if CDS 0 (index[0]) is selected, the inverter receives its ON/OFF1 command via DI 3.		
p1113[0 ... n] = 722.x	<b>BI: Setpoint inversion</b> (reversing)		

## 6.2.5 Two-wire control, method 2

You switch the motor on and off using a control command (ON/OFF1) and at the same time select clockwise motor rotation. You also use the other control command to switch the motor on and off, but in this case you select counter-clockwise rotation for the motor.

The inverter only accepts a new control command when the motor is at a standstill.

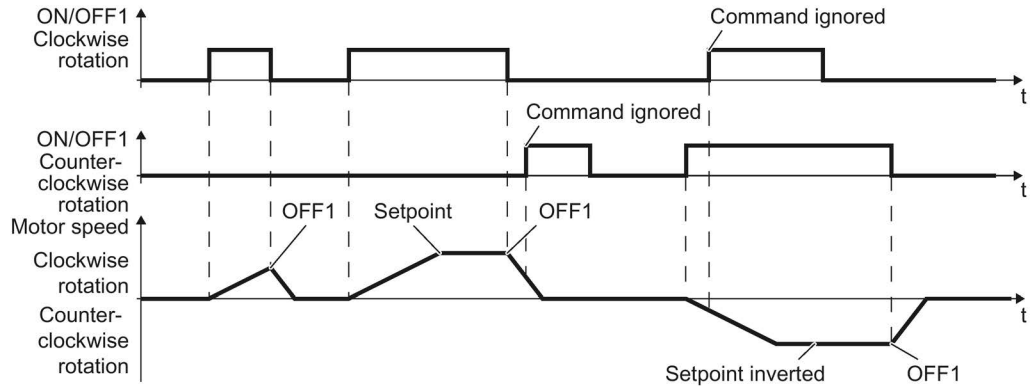

Image 6-7 Two-wire control, method 2

Table 6-8 Function table

ON/OFF1 clockwise rotation	ON/OFF1 counter-clockwise rotation	Function
0	0	OFF1: The motor stops.
1	0	ON: Clockwise motor rotation.
0	1	ON: Counter-clockwise motor rotation.
1	1	ON: The motor direction of rotation is based on the signal that assumes status "1" first.

Parameter	Description		
p0015 = 17	<b>Macro drive unit</b>		
	Controlling the motor using the digital inputs of the inverter:	DI 0 ON/OFF1 clockwise rotation	DI 1 ON/OFF1 counter-clockwise rotation
<b>Advanced setting</b> Interconnecting control commands with digital inputs of your choice.			
p3330[0 ... n] = 722.x	<b>BI: 2/3 wire control command 1</b> (ON/OFF1 clockwise rotation)		
p3331[0 ... n] = 722.x	<b>BI: 2/3 wire control command 2</b> (ON/OFF1 counter-clockwise rotation) Example: p3331[0] = 722.0 ⇒ if CDS 0 (index[0]) is selected, the inverter receives its ON/OFF1 counter-clockwise command via DI 0.		

### 6.2.6 Two-wire control, method 3

You switch the motor on and off using a control command (ON/OFF1) and at the same time select clockwise motor rotation. You also use the other control command to switch the motor on and off, but in this case you select counter-clockwise rotation for the motor.

Unlike method 2, the inverter will accept the control commands at any time, regardless of the motor speed.

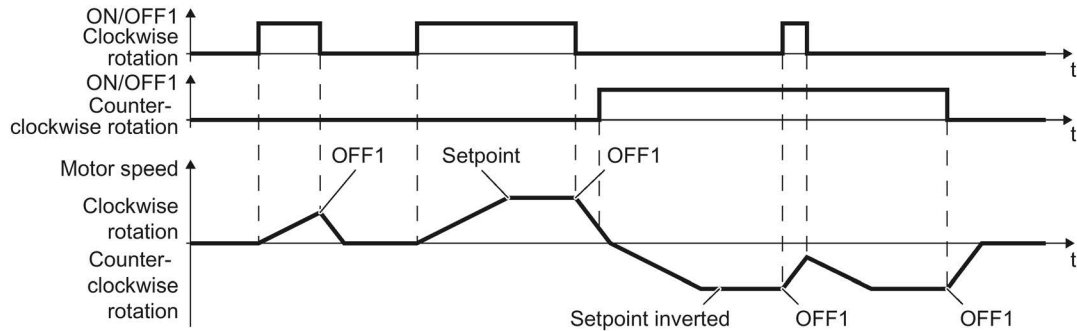

Image 6-8 Two-wire control, method 3

Table 6-9 Function table

ON/OFF1 clockwise rotation	ON/OFF1 counter-clockwise rotation	Function
0	0	OFF1: The motor stops.
1	0	ON: Clockwise motor rotation.
0	1	ON: Counter-clockwise motor rotation.
1	1	OFF1: The motor stops.

Parameter	Description		
p0015 = 18	<b>Macro drive unit</b>		
	Controlling the motor using the digital inputs of the inverter:	DI 0	DI 1
		ON/OFF1 clockwise rotation	ON/OFF1 counter-clockwise rotation
<b>Advanced setting</b>			
Interconnecting control commands with digital inputs of your choice.			
p3330[0 ... n] = 722.x	<b>BI: 2/3 wire control command 1</b> (ON/OFF1 clockwise rotation)		
p3331[0 ... n] = 722.x	<b>BI: 2/3 wire control command 2</b> (ON/OFF1 counter-clockwise rotation) Example: p3331[0] = 722.0 ⇒ if CDS 0 (index[0]) is selected, the inverter receives its ON/OFF1 counter-clockwise command via DI 0.		



## 6.2.7 Three-wire control, method 1

With one control command, you enable the two other control commands. You switch the motor off by withdrawing the enable (OFF1).

You switch the motor's direction of rotation to clockwise rotation with the positive edge of the second control command. If the motor is still switched off, switch it on (ON).

You switch the motor's direction of rotation to counter-clockwise rotation with the positive edge of the third control command. If the motor is still switched off, switch it on (ON).

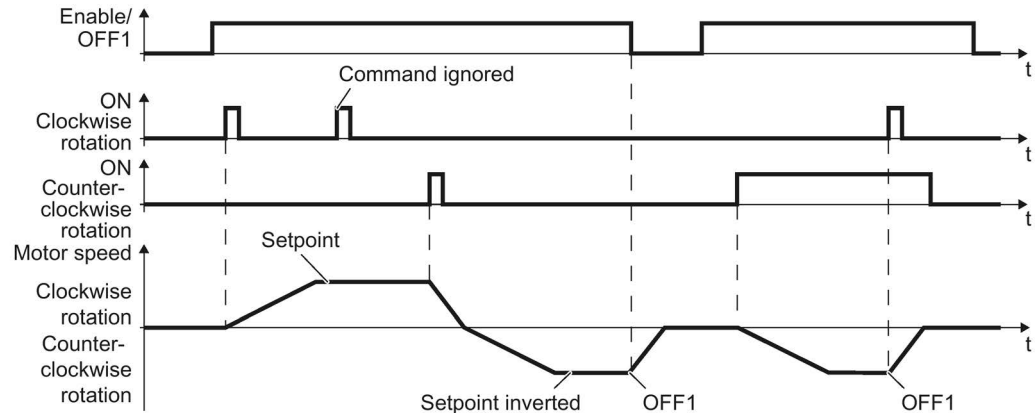

Image 6-9 Three-wire control, method 1

Table 6- 10 Function table

Enable / OFF1	ON clockwise rotation	ON counter-clockwise rotation	Function
0	0 or 1	0 or 1	OFF1: The motor stops.
1	0→1	0	ON: Clockwise motor rotation.
1	0	0→1	ON: Counter-clockwise motor rotation.
1	1	1	OFF1: The motor stops.

Parameter	Description			
p0015 = 19	<b>Macro drive unit</b>			
	Controlling the motor using the digital inputs of the inverter:	DI 0	DI 1	DI 2
		Enable / OFF1	ON clockwise rotation	ON counter-clockwise rotation
<b>Advanced setting</b>				
Interconnecting control commands with digital inputs of your choice (DI x).				
p3330[0 ... n] = 722.x	<b>BI: 2/3 wire control command 1 (enable/OFF1)</b>			
p3331[0 ... n] = 722.x	<b>BI: 2/3 wire control command 2 (ON clockwise rotation)</b>			
p3332[0 ... n] = 722.x	<b>BI: 2/3 wire control command 3 (ON counter-clockwise rotation)</b>			
	Example: p3332[0] = 722.0 ⇒ if CDS 0 (index[0]) is selected, the inverter receives its ON counter-clockwise command via DI 0.			

### 6.2.8 Three-wire control, method 2

With one control command, you enable the two other control commands. You switch the motor off by withdrawing the enable (OFF1).

You switch on the motor with the positive edge of the second control command (ON).

The third control command defines the motor's direction of rotation (reversing).

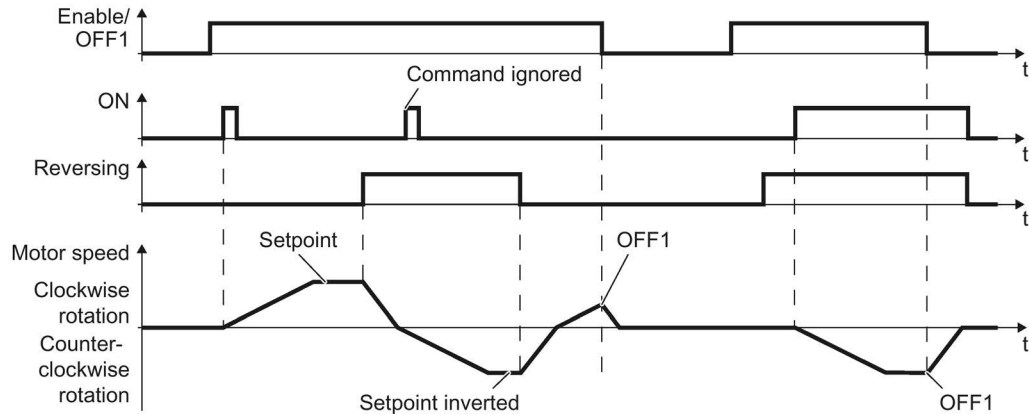

Image 6-10 Three-wire control, method 2

Table 6- 11 Function table

Enable / OFF1	ON	Reversing	Function
0	0 or 1	0 or 1	OFF1: The motor stops.
1	0→1	0	ON: Clockwise motor rotation.
1	0→1	1	ON: Counter-clockwise motor rotation.

Parameter	Description			
p0015 = 20	<b>Macro drive unit</b>			
	Controlling the motor using the digital inputs of the inverter:	DI 0	DI 1	DI 2
		Enable / OFF1	ON	Reversing
<b>Advanced setting</b>				
Interconnecting control commands with digital inputs of your choice (DI x).				
p3330[0 ... n] = 722.x	<b>BI: 2/3 wire control command 1</b> (enable/OFF1)			
p3331[0 ... n] = 722.x	<b>BI: 2/3 wire control command 2</b> (ON) Example: p3331[0] = 722.0 ⇒ if CDS 0 (index[0]) is selected, the inverter receives its ON command via DI 0.			
p3332[0 ... n] = 722.x	<b>BI: 2/3 wire control command 3</b> (reversing)			

## 6.2.9 Running the motor in jog mode (JOG function)

The "Jog" function is typically used to slowly move a machine part, e.g. a conveyor belt.

With the "Jog" function, you switch the motor on and off using a digital input. When the motor is switched on, it accelerates to the jogging setpoint. There are two different setpoints available, e.g. for motor counter-clockwise rotation and clockwise rotation.

The same ramp-function generator acts on the setpoint as for the ON/OFF1 command.

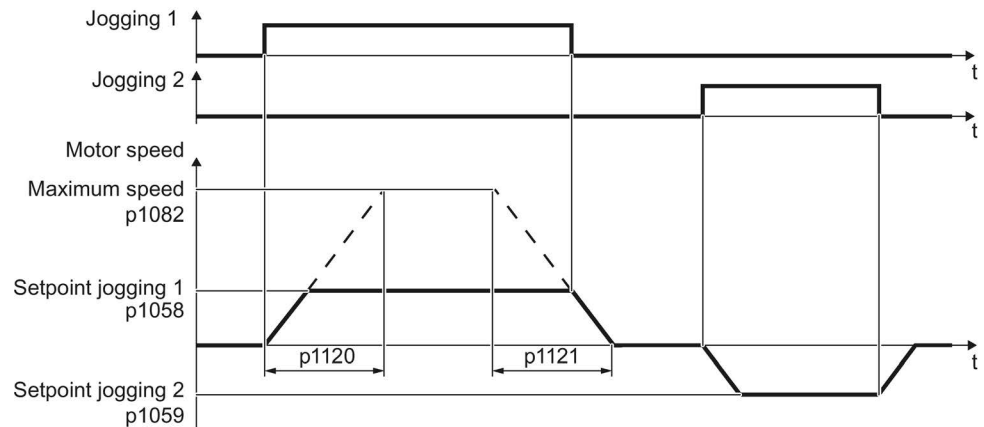
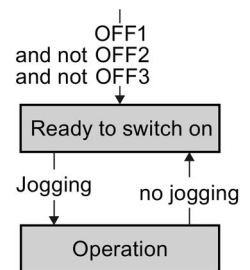

Image 6-11 Behavior of the motor when "jogging"

The inverter must be ready to start before you issue the "Jog" control command. If the motor is already switched on, then the "Jog" command has no effect.



**Jog settings**

Parameter	Description	
p1058	<b>Jogging 1 speed setpoint</b> (factory setting 150 rpm)	
p1059	<b>Jogging 2 speed setpoint</b> (factory setting -150 rpm)	
p1082	<b>Maximum speed</b> (factory setting 1500 rpm)	
p1110	<b>Inhibit negative direction</b>	
	=0: Negative direction of rotation is enabled	=1: Negative direction of rotation is inhibited
p1111	<b>Inhibit positive direction</b>	
	=0: Positive direction of rotation is enabled	=1: Positive direction of rotation is inhibited
p1113	<b>Setpoint inversion</b>	
	=0: Setpoint is not inverted	=1: Setpoint is inverted
p1120	<b>Ramp-function generator ramp-up time</b> (factory setting 10 s)	
p1121	<b>Ramp-function generator ramp-down time</b> (factory setting 10 s)	
p1055 = 722.0	<b>Jog bit 0:</b> Select jogging 1 via digital input 0	
p1056 = 722.1	<b>Jog bit 1:</b> Select jogging 2 via digital input 1	

## 6.2.10 Control via PROFIBUS or PROFINET with the PROFIdrive profile

The send and receive telegrams of the inverter for the cyclic communication are structured as follows:

PKW	PZD01	PZD02	PZD03	PZD04	PZD05	PZD06	PZD07	PZD08	.....
-----	-------	-------	-------	-------	-------	-------	-------	-------	-------

**Telegram 1, speed control**

STW1	NSOLL_A
ZSW1	NIST_A

**Telegram 20, speed control, VIK/NAMUR**

STW1	NSOLL_A				
ZSW1	NIST_A GLATT	IAIST_ GLATT	MIST_ GLATT	PIST_ GLATT	MELD_ NAMUR

**Telegram 350, Closed-loop speed Control with limitation of the torque**

STW1	NSOLL_A	M_LIM	STW3
ZSW1	NIST_A GLATT	IAIST_ GLATT	ZSW3

**Telegram 352, speed control for PCS7**

STW1	NSOLL_A	Process data for PCS7			
ZSW1	NIST_A GLATT	IAIST_ GLATT	MIST_ GLATT	WARN_ CODE	FAULT_ CODE

**Telegram 353, speed control with PKW area to read and write parameters**

PKW	STW1	NSOLL_A
PKW	ZSW1	NIST_A GLATT

**Telegram 354, speed control for PCS7 with PKW area to read and write parameters**

PKW	STW1	NSOLL_A	Process data for PCS7			
PKW	ZSW1	NIST_A GLATT	IAIST_ GLATT	MIST_ GLATT	WARN_ CODE	FAULT_ CODE

**Telegram 999, free interconnection**

STW1	Telegram length can be configured for the receive data							
ZSW1	Telegram length can be configured for the transmit data							

Image 6-12 Telegrams for cyclic communication

Table 6- 12 Explanation of the abbreviations

Abbreviation	Explanation	Abbreviation	Explanation
STW	Control word	MIST_GLATT	Actual smoothed torque
ZSW	Status word	PIST_GLATT	Actual smoothed active power
NSOLL_A	Speed setpoint	M_LIM	Torque limit value
NIST_A	Speed actual value	FAULT_CODE	Fault number
NIST_A_GLATT	Smoothed actual speed value	WARN_CODE	Alarm number
IAIST_GLATT	Smoothed current actual value	MELD_NAMUR	Control word according to the VIK-NAMUR definition

Interconnection of the process data

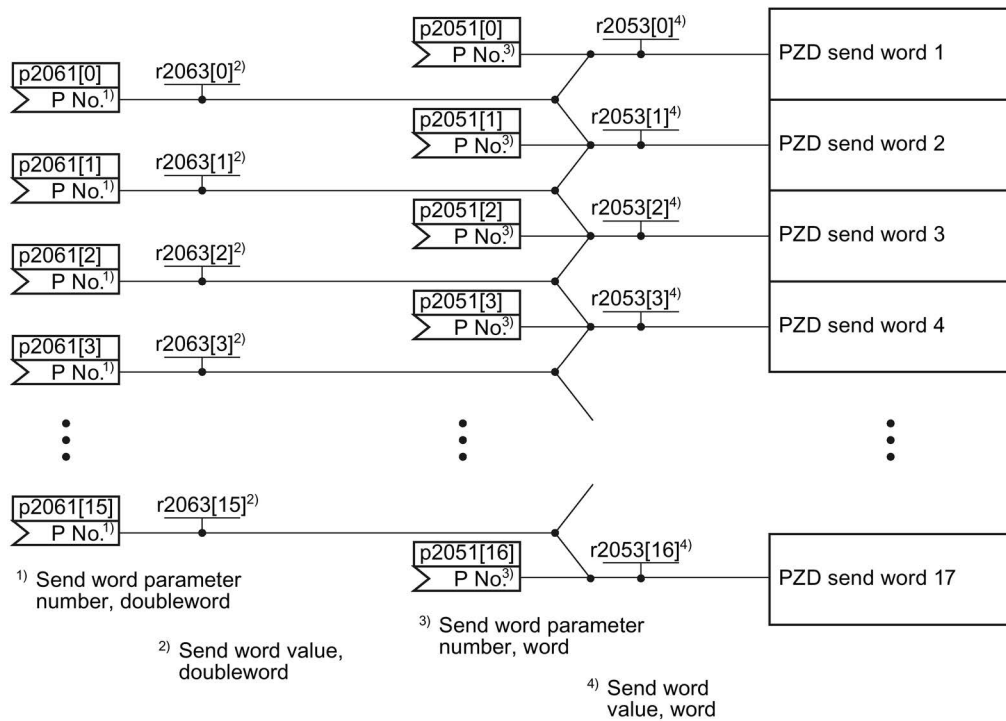

Image 6-13 Interconnection of the send words

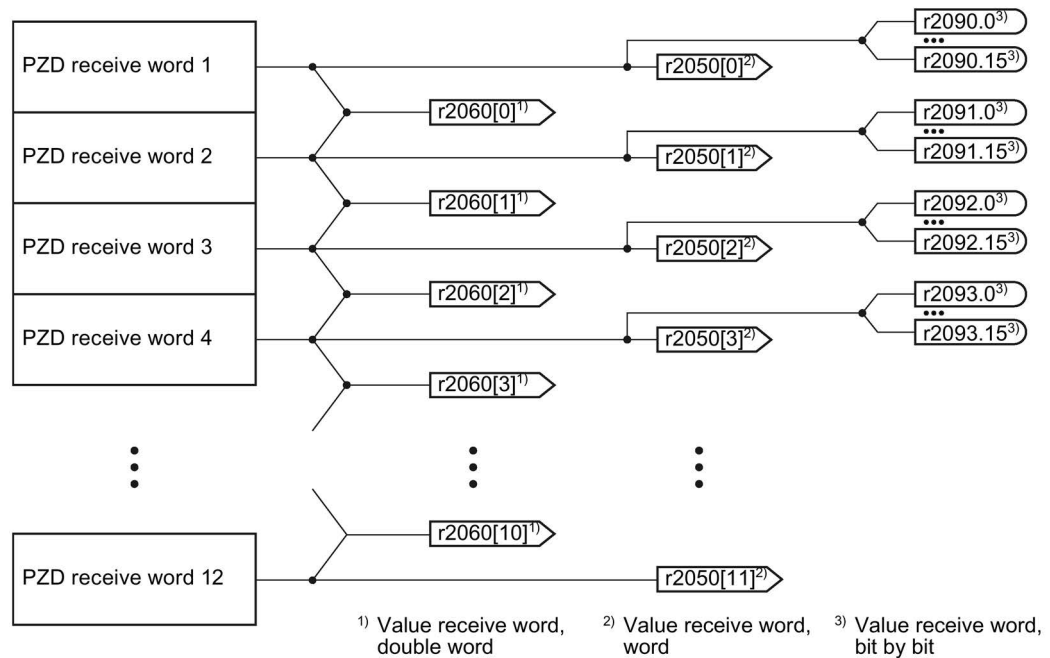

Image 6-14 Interconnection of the receive words

The telegrams use - with the exception of telegram 999 (free interconnection) - the word-by-word transfer of send and receive data (r2050/p2051).

If you require an individual telegram for your application (e.g. for transferring double words), you can adjust one of the predefined telegrams via parameters p0922 and p2079. For details, please refer to the List Manual, function diagrams 2420 and 2472.

### 6.2.10.1 Control and status word 1

#### Control word 1 (STW1)

Bit	Significance		Explanation	Signal inter-connection in the inverter
	Telegram 20	All other telegrams		
0	0 = OFF1		The motor brakes with the ramp-down time p1121 of the ramp-function generator. The inverter switches off the motor at standstill.	p0840[0] = r2090.0
	0 → 1 = ON		The inverter goes into the "ready" state. If, in addition bit 3 = 1, then the inverter switches on the motor.	
1	0 = OFF2		Switch off the motor immediately, the motor then coasts down to a standstill.	p0844[0] = r2090.1
	1 = No OFF2		The motor can be switched on (ON command).	

Bit	Significance		Explanation	Signal inter-connection in the inverter
	Telegram 20	All other telegrams		
2	0 = Quick stop (OFF3)		Quick stop: The motor brakes with the OFF3 ramp-down time p1135 down to standstill.	p0848[0] = r2090.2
	1 = No quick stop (OFF3)		The motor can be switched on (ON command).	
3	0 = Inhibit operation		Immediately switch-off motor (cancel pulses).	p0852[0] = r2090.3
	1 = Enable operation		Switch-on motor (pulses can be enabled).	
4	0 = Disable RFG		The inverter immediately sets its ramp-function generator output to 0.	p1140[0] = r2090.4
	1 = Do not disable RFG		The ramp-function generator can be enabled.	
5	0 = Stop RFG		The output of the ramp-function generator stops at the actual value.	p1141[0] = r2090.5
	1 = Enable RFG		The output of the ramp-function generator follows the setpoint.	
6	0 = Inhibit setpoint		The inverter brakes the motor with the ramp-down time p1121 of the ramp-function generator.	p1142[0] = r2090.6
	1 = Enable setpoint		Motor accelerates with the ramp-up time p1120 to the setpoint.	
7	0 → 1 = Acknowledge faults		Acknowledge fault. If the ON command is still active, the inverter switches to "closing lockout" state.	p2103[0] = r2090.7
8, 9	Reserved			
10	0 = No control via PLC		Inverter ignores the process data from the fieldbus.	p0854[0] = r2090.10
	1 = Control via PLC		Control via fieldbus, inverter accepts the process data from the fieldbus.	
11	1 = Direction reversal		Invert setpoint in the inverter.	p1113[0] = r2090.11
12	Not used			
13	--- <sup>1)</sup>	1 = MOP up	Increase the setpoint saved in the motorized potentiometer.	p1035[0] = r2090.13
14	--- <sup>1)</sup>	1 = MOP down	Reduce the setpoint saved in the motorized potentiometer.	p1036[0] = r2090.14
15	CDS bit 0	Reserved	Changes over between settings for different operation interfaces (command data sets).	p0810 = r2090.15

<sup>1)</sup> If you change over from another telegram to telegram 20, then the assignment of the previous telegram is kept.



## Status word 1 (ZSW1)

Bit	Significance		Comments	Signal inter-connection in the inverter
	Telegram 20	All other telegrams		
0	1 = Ready to start		Power supply switched on; electronics initialized; pulses locked.	p2080[0] = r0899.0
1	1 = Ready		Motor is switched on (ON/OFF1 = 1), no fault is active. With the command "Enable operation" (STW1.3), the inverter switches on the motor.	p2080[1] = r0899.1
2	1 = Operation enabled		Motor follows setpoint. See control word 1, bit 3.	p2080[2] = r0899.2
3	1 = Fault active		The inverter has a fault. Acknowledge fault using STW1.7.	p2080[3] = r2139.3
4	1 = OFF2 inactive		Coast down to standstill is not active.	p2080[4] = r0899.4
5	1 = OFF3 inactive		Quick stop is not active.	p2080[5] = r0899.5
6	1 = Closing lockout active		It is only possible to switch on the motor after an OFF1 followed by ON.	p2080[6] = r0899.6
7	1 = Alarm active		Motor remains switched on; no acknowledgement is necessary.	p2080[7] = r2139.7
8	1 = Speed deviation within the tolerance range		Setpoint / actual value deviation within the tolerance range.	p2080[8] = r2197.7
9	1 = Master control requested		The automation system is requested to accept the inverter control.	p2080[9] = r0899.9
10	1 = Comparison speed reached or exceeded		Speed is greater than or equal to the corresponding maximum speed.	p2080[10] = r2199.1
11	1 = current or torque limit reached	1 = torque limit reached	Comparison value for current or torque has been reached or exceeded.	p2080[11] = r0056.13 / r1407.7
12	--- <sup>1)</sup>	1 = Holding brake open	Signal to open and close a motor holding brake.	p2080[12] = r0899.12
13	0 = Alarm, motor overtemperature		--	p2080[13] = r2135.14
14	1 = Motor rotates clockwise		Internal inverter actual value > 0	p2080[14] = r2197.3
	0 = Motor rotates counterclockwise		Internal inverter actual value < 0	
15	1 = CDS display	0 = Alarm, inverter thermal overload		p2080[15] = r0836.0 / r2135.15

<sup>1)</sup> If you change over from another telegram to telegram 20, then the assignment of the previous telegram is kept.

## 6.2.10.2 Control and status word 3

## Control word 3 (STW3)

Bit	Significance	Explanation	Signal interconnection in the inverter <sup>1)</sup>
	Telegram 350		
0	1 = fixed setpoint bit 0	Selects up to 16 different fixed setpoints.	p1020[0] = r2093.0
1	1 = fixed setpoint bit 1		p1021[0] = r2093.1
2	1 = fixed setpoint bit 2		p1022[0] = r2093.2
3	1 = fixed setpoint bit 3		p1023[0] = r2093.3
4	1 = DDS selection bit 0	Changes over between settings for different motors (drive data sets).	p0820 = r2093.4
5	1 = DDS selection bit 1		p0821 = r2093.5
6	Not used		
7	Not used		
8	1 = technology controller enable	--	p2200[0] = r2093.8
9	1 = enable DC braking	--	p1230[0] = r2093.9
10	Not used		
11	1 = Enable droop	Enable or inhibit speed controller droop.	p1492[0] = r2093.11
12	1 = torque control active 0 = speed control active	Changes over the control mode for vector control.	p1501[0] = r2093.12
13	1 = no external fault 0 = external fault is active (F07860)	--	p2106[0] = r2093.13
14	Not used		
15	1 = CDS bit 1	Changes over between settings for different operation interfaces (command data sets).	p0811[0] = r2093.15

<sup>1)</sup> If you switch from telegram 350 to a different one, then the inverter sets all interconnections p1020, ... to "0". Exception: p2106 = 1.

## Status word 3 (ZSW3)

Bit	Significance	Description	Signal interconnection in the inverter
0	1 = DC braking active	--	p2051[3] = r0053
1	1 = $ n_{act}  > p1226$	Absolute current speed > stationary state detection	
2	1 = $ n_{act}  > p1080$	Absolute actual speed > minimum speed	
3	1 = $i_{act} \geq p2170$	Actual current $\geq$ current threshold value	
4	1 = $ n_{act}  > p2155$	Absolute actual speed > speed threshold value 2	
5	1 = $ n_{act}  \leq p2155$	Absolute actual speed < speed threshold value 2	
6	1 = $ n_{act}  \geq r1119$	Speed setpoint reached	
7	1 = DC link voltage $\leq p2172$	Actual DC link voltage $\leq$ threshold value	
8	1 = DC link voltage > p2172	Actual DC link voltage > threshold value	
9	1 = ramp-up or ramp-down completed	Ramp-function generator is not active.	
10	1 = technology controller output at the lower limit	Technology controller output $\leq p2292$	
11	1 = technology controller output at the upper limit	Technology controller output > p2291	
12	Not used		
13	Not used		
14	Not used		
15	Not used		

6.2.10.3 NAMUR message word

Fault word according to the VIK-NAMUR definition (MELD\_NAMUR)

Table 6- 13 Fault word according to the VIK-NAMUR definition and interconnection with parameters in the inverter

Bit	Significance	P no.
0	1 = Control Unit signals a fault	p2051[5] = r3113
1	1 = line fault: Phase failure or inadmissible voltage	
2	1 = DC link overvoltage	
3	1 = Power Module fault, e.g. overcurrent or overtemperature	
4	1 = inverter overtemperature	
5	1 = ground fault/phase fault in the motor cable or in the motor	
6	1 = motor overload	
7	1 = communication error to the higher-level control system	
8	1 = fault in a safety-relevant monitoring channel	
10	1 = fault in the internal inverter communication	
11	1 = line fault	
15	1 = other fault	

6.2.10.4 Data structure of the parameter channel

Structure of the parameter channel

The parameter channel consists of four words. 1. and 2nd word transfer the parameter number and index as well as the type of job (read or write) The 3rd and 4th word contains the parameter contents. The parameter contents can be 16-bit values (such as baud rate) or 32-bit values (e.g. CO parameters).

Bit 11 in the 1st word is reserved and is always assigned 0.

Parameter channel							
PKE (1st word)			IND (2nd word)			PWE (3rd and 4th words)	
15 ... 12	11	10 ... 0	15 ... 8	7 ... 0	15 ... 0	15 ... 0	
AK	S	PNU	Subindex	Page index	PWE 1	PWE 2	
	P						
	M						

You can find examples of telegrams at the end of this section.

## Request and response IDs

Bits 12 ... 15 of the 1st word of the parameter channel contain the request and response identifier.

Table 6- 14 Request identifiers, control → inverter

Request identifier	Description	Response identifier	
		positive	negative
0	No request	0	7 / 8
1	Request parameter value	1 / 2	7 / 8
2	Change parameter value (word)	1	7 / 8
3	Change parameter value (double word)	2	7 / 8
4	Request descriptive element <sup>1)</sup>	3	7 / 8
6 <sup>2)</sup>	Request parameter value (field) <sup>1)</sup>	4 / 5	7 / 8
7 <sup>2)</sup>	Change parameter value (field, word) <sup>1)</sup>	4	7 / 8
8 <sup>2)</sup>	Change parameter value (field, double word) <sup>1)</sup>	5	7 / 8
9	Request number of field elements	6	7 / 8

<sup>1)</sup> The required element of the parameter is specified in IND (2nd word).

<sup>2)</sup> The following request IDs are identical: 1 ≡ 6, 2 ≡ 7 3 ≡ 8.  
We recommend that you use identifiers 6, 7, and 8.

Table 6- 15 Response identifiers, inverter → control

Response identifier	Description
0	No response
1	Transfer parameter value (word)
2	Transfer parameter value (double word)
3	Transfer descriptive element <sup>1)</sup>
4	Transfer parameter value (field, word) <sup>2)</sup>
5	Transfer parameter value (field, double word) <sup>2)</sup>
6	Transfer number of field elements
7	Inverter cannot process the request. In the most significant word of the parameter channel, the inverter sends an error number to the control, refer to the following table.
8	No master controller status / no authorization to change parameters of the parameter channel interface

<sup>1)</sup> The required element of the parameter is specified in IND (2nd word).

<sup>2)</sup> The required element of the indexed parameter is specified in IND (2nd word).

Table 6- 16 Error numbers for response identifier 7

No.	Description
00 hex	<b>Illegal parameter number</b> (access to a parameter that does not exist)
01 hex	<b>Parameter value cannot be changed</b> (change request for a parameter value that cannot be changed)
02 hex	<b>Lower or upper value limit exceeded</b> (change request with a value outside the value limits)
03 hex	<b>Incorrect subindex</b> (access to a subindex that does not exist.)
04 hex	<b>No array</b> (access with a subindex to non-indexed parameters)
05 hex	<b>Incorrect data type</b> (change request with a value that does not match the data type of the parameter)
06 hex	<b>Setting not permitted, only resetting</b> (change request with a value not equal to 0 without permission)
07 hex	<b>Descriptive element cannot be changed</b> (change request to a descriptive element error value that cannot be changed)
0B hex	<b>No master control</b> (change request but with no master control, see also p0927.)
0C hex	<b>Keyword missing</b>
11 hex	<b>Request cannot be executed due to the operating state</b> (access is not possible for temporary reasons that are not specified)
14 hex	<b>Inadmissible value</b> (change request with a value that is within the limits but which is illegal for other permanent reasons, i.e. a parameter with defined individual values)
65 hex	<b>Parameter number is currently deactivated</b> (depending on the mode of the inverter)
66 hex	<b>Channel width is insufficient</b> (communication channel is too small for response)
68 hex	<b>Illegal parameter value</b> (parameter can only assume certain values)
6A hex	<b>Request not included / task is not supported</b> (the valid request identifications can be found in table "Request identifications controller → inverter")
6B hex	<b>No change access for a closed-loop controller that is enabled.</b> (The operating state of the inverter prevents a parameter change.)
86 hex	<b>Write access only for commissioning (p0010 = 15)</b> (operating status of the inverter prevents a parameter change)
87 hex	<b>Know-how protection active, access locked</b>
C8 hex	<b>Change request below the currently valid limit</b> (change request to a value that lies within the "absolute" limits, but is however below the currently valid lower limit)
C9 hex	<b>Change request above the currently valid limit</b> (example: a parameter value is too large for the inverter power)
CC hex	<b>Change request not permitted</b> (change is not permitted as the access code is not available)

## Offset and page index of the parameter numbers

- Parameter numbers < 2000 PNU = parameter number.  
Write the parameter number into the PNU (PKE bit 10 ... 0).
- Parameter numbers ≥ 2000 PNU = parameter number - offset.  
Write the parameter number minus the offset into the PNU (PKE bit 10 ... 0).  
Write the offset in the page index (IND bit 7 ... 0).

Parameter number	Offset	Page index								
		Hex	Bit 7	Bit 6	Bit 5	Bit 4	Bit 3	Bit 2	Bit 1	Bit 0
0000 ... 1999	0	0 hex	0	0	0	0	0	0	0	0
2000 ... 3999	2000	80 hex	1	0	0	0	0	0	0	0
6000 ... 7999	6000	90 hex	1	0	0	1	0	0	0	0
8000 ... 9999	8000	20 hex	0	0	1	0	0	0	0	0
10000 ... 11999	10000	A0 hex	1	0	1	0	0	0	0	0
20000 ... 21999	20000	50 hex	0	1	0	1	0	0	0	0
30000 ... 31999	30000	F0 hex	1	1	1	1	0	0	0	0
60000 ... 61999	60000	74 hex	0	1	1	1	0	1	0	0

## Indexed parameters

For indexed parameters, you must write the index as hex value into the subindex (IND bit 15 ... 8).

## Parameter contents

Parameter contents can be parameter values or connectors.

Table 6- 17 Parameter values in the parameter channel

PWE, 3rd word		PWE, 4th word	
Bit 15 ... 0		Bit 15 ... 8	Bit 7 ... 0
0		0	8-bit value
0		16-bit value	
32-bit value			

Table 6- 18 Connectors in the parameter channel

PWE, 3rd word		PWE, 4th word	
Bit 15 ... 0		Bit 15 ... 10	Bit 9 ... 0
Number of the connector		3F hex	The index or bit field number of the connector





**Write request: Assign digital input 2 with the function ON/OFF1 (p0840[1] = 722.2)**

In order to link digital input 2 with ON/OFF1, you must assign parameter p0840[1] (source, ON/OFF1) the value 722.2 (DI 2). To do this, you must fill the telegram of the parameter channel as follows:

- **PKE, bit 12 ... 15 (AK): = 7 hex** (change, parameter value (field, word))
- **PKE, bit 0 ... 10 (PNU): = 348 hex** (840 = 348 hex, no offset, as 840 < 1999)
- **IND, bit 8 ... 15 (subindex): = 1 hex** (CDS1 = index1)
- **IND, bit 0 ... 7 (page index): = 0 hex** (offset 0  $\triangleq$  0 hex)
- **PWE1, bit 0 ... 15: = 2D2 hex** (722 = 2D2 hex)
- **PWE2, bit 10 ... 15: = 3F hex** (drive object - for SINAMICS G120, always 63 = 3f hex)
- **PWE2, bit 0 ... 9: = 2 hex** (index of parameter (DI 2 = 2))

Parameter channel																																																												
PKE, 1st word								IND, 2nd word								PWE1 - high, 3rd word								PWE2 - low, 4th word																																				
15 ... 12				11 ... 10				15 ... 8				7 ... 0				15 ... 0								15 ... 10				9 ... 0																																
AK				Parameter number				Subindex				Page index				Parameter value								Drive Object				Index																																
0	1	1	1	0	0	1	1	0	1	0	1	0	0	1	0	0	0	0	0	0	0	1	0	0	0	0	0	0	0	0	0	0	0	0	1	0	1	1	0	1	0	0	1	0	1	1	1	1	1	1	1	0	0	0	0	0	0	0	1	0

Image 6-17 Telegram, to assign DI 2 with ON/OFF1

### 6.2.10.6 Extend telegrams and change signal interconnection

When you have selected a telegram, the inverter interconnects the corresponding signals with the fieldbus interface. Generally, these interconnections are protected so that they cannot be changed. With the appropriate inverter settings, these interconnections can be changed.

#### Extend telegram

Every telegram can be extended, by "attaching" additional signals.

##### Procedure



1 Proceed as follows to extend a telegram:

1. Using STARTER or an operator panel, set parameter p0922 = 999.
2. Set parameter p2079 to the appropriate value of the corresponding telegram.
3. Interconnect additional PZD send words and PZD receive words with signals of your choice via parameters r2050 and p2051.



You have extended the telegram.

Parameter	Description
p0922	<b>PROFIdrive telegram selection</b>
	999: Free telegram (message frame) configuration
p2079	<b>PROFIdrive PZD telegram selection extended</b>
	1: Standard telegram 1, PZD-2/2
	20: Standard telegram 20, PZD-2/6
	350: SIEMENS telegram 350, PZD-4/4
	352: SIEMENS telegram 352, PZD-6/6
	353: SIEMENS telegram 353, PZD-2/2, PKW-4/4
354: SIEMENS telegram 354, PZD-6/6, PKW-4/4	
r2050[0...11]	<b>PROFIdrive PZD receive word</b> Connector output to interconnect the PZD (setpoints) in the word format received from the PROFIdrive controller.
p2051[0...16]	<b>PROFIdrive PZD send word</b> Selection of the PZD (actual values) in the word format to be sent to the PROFIdrive controller.

Selection of the PZD (actual values) in the word format to be sent to the PROFIdrive controller. For further information refer to the function block diagrams 2468 and 2470 of the List Manual.

## Freely selecting the signal interconnection of the telegram

The signals in the telegram can be freely interconnected.

### Procedure



1 Proceed as follows to change the signal interconnection of a telegram:

1. Using STARTER or an operator panel, set parameter p0922 = 999.
2. Using STARTER or an operator panel, set parameter p2079 = 999.
3. Interconnect additional PZD send words and PZD receive words with signals of your choice via parameters r2050 and p2051.



You have freely interconnected the signals transferred in the telegram.

Parameter	Description
p0922	<b>PROFIdrive telegram selection</b>
	999: Free telegram (message frame) configuration
p2079	<b>PROFIdrive PZD telegram selection extended</b>
	999: Free telegram (message frame) configuration
r2050[0...11]	<b>PROFIdrive PZD receive word</b> Connector output to interconnect the PZD (setpoints) in the word format received from the PROFIdrive controller.
p2051[0...16]	<b>PROFIdrive PZD send word</b> Selection of the PZD (actual values) in the word format to be sent to the PROFIdrive controller.

For further information refer to the function block diagrams 2468 and 2470 of the List Manual.

### 6.2.10.7 Configuring the IP interface

#### Configure communication with STARTER

STARTER provides a screen form to set the communication with the control system.

Open the dialog screen form "Control\_Unit/Communication/Commissioning interface" and activate the "Configure IP interfaces" tab

Commissioning interfaces IP interface configuration

PROFINET onboard / X150

DHCP mode [0] DHCP off

Device name

Device address 0.0.0.0

Standard gateway 0.0.0.0

Subnet mask 0.0.0.0

Activation [0] No function

 For G devices, the settings only take effect after Power OFF -> ON!

- Set the DHCP mode to 0 (factory setting).
- Enter the device name, address, gateway and the address for the subnet mask.
- In the Activation field select "[2] Save and activate configuration".
- To activate the settings, you must switch off the inverter power supply and then switch on again.

You can also enter or read out data using the expert list. You can find the corresponding parameters in the number range r8909 ... p8925

### 6.2.10.8 Slave-to-slave communication

"Direct data exchange" is sometimes called "slave-to-slave communication" or "data exchange broadcast". With direct data exchange, slaves exchange data without any direct involvement of the master.

Further information about the "Direct data exchange" function is provided in the Fieldbus function manual.



Overview of the manuals (Page 507)

### 6.2.10.9 Acyclically reading and writing inverter parameters

The inverter supports the writing and reading of parameters via acyclic communication:

- For PROFIBUS: Up to 240 bytes per write or read request via data set 47
- For PROFINET: Write or read requests via B02E hex and B02F hex

Further information about acyclic communication is provided in the Fieldbus function manual.



Overview of the manuals (Page 507)

### "Reading and writing parameters" application example



Further information is provided in the Internet:

Application examples (<https://support.industry.siemens.com/cs/ww/en/view/29157692>)

## 6.2.11 Control via additional fieldbuses

### 6.2.11.1 Modbus RTU

#### Settings for Modbus RTU

Parameter	Explanation		
p2020	<b>Fieldbus interface baudrate</b> (Factory setting: 7)	5: 4800 baud 6: 9600 baud 7: 19200 baud 8: 38400 baud 9: 57600 baud	10: 76800 baud 11: 93750 baud 12: 115200 baud 13: 187500 baud
p2021	<b>Fieldbus interface address</b> (Factory setting: 1) Valid addresses: 1 ... 247. The parameter is only active if address 0 is set at the Control Unit address switch. A change only becomes effective after the inverter power supply has been switched off and switched on again.		
p2024	<b>Fieldbus interface times</b> (Factory setting: [0] 1000 ms, [2] 0 ms)	[0] Maximum permissible telegram processing time of the Modbus slave [2] dead time between two telegrams	
r2029	<b>Fieldbus interface error statistics</b>	[0] number of error-free telegrams [1] number of rejected telegrams [2] number of framing errors [3] number of overrun errors	[4] number of parity errors [5] number of starting character errors [6] number of checksum errors [7] number of length errors
p2030 = 2	<b>Fieldbus interface protocol selection:</b> Modbus RTU		
p2031	<b>Fieldbus interface Modbus parity</b> (Factory setting: 2)	0: No parity 1: Odd parity 2: Even parity	
p2040	<b>Fieldbus interface monitoring time</b> (Factory setting: 100 ms) p2040 = 0: The monitoring is deactivated		

## Control word 1 (STW1)

Bit	Meaning	Explanation	Signal inter-connection in the inverter
0	0 = OFF1	The motor brakes with the ramp-down time p1121 of the ramp-function generator. The inverter switches off the motor at standstill.	p0840[0] = r2090.0
	0 → 1 = ON	The inverter goes into the "ready" state. If, in addition bit 3 = 1, then the inverter switches on the motor.	
1	0 = OFF2	Switch off the motor immediately, the motor then coasts down to a standstill.	p0844[0] = r2090.1
	1 = No OFF2	The motor can be switched on (ON command).	
2	0 = Quick stop (OFF3)	Quick stop: The motor brakes with the OFF3 ramp-down time p1135 down to standstill.	p0848[0] = r2090.2
	1 = No quick stop (OFF3)	The motor can be switched on (ON command).	
3	0 = Inhibit operation	Immediately switch-off motor (cancel pulses).	p0852[0] = r2090.3
	1 = Enable operation	Switch-on motor (pulses can be enabled).	
4	0 = Disable RFG	The inverter immediately sets its ramp-function generator output to 0.	p1140[0] = r2090.4
	1 = Do not disable RFG	The ramp-function generator can be enabled.	
5	0 = Stop RFG	The output of the ramp-function generator stops at the actual value.	p1141[0] = r2090.5
	1 = Enable RFG	The output of the ramp-function generator follows the setpoint.	
6	0 = Inhibit setpoint	The inverter brakes the motor with the ramp-down time p1121 of the ramp-function generator.	p1142[0] = r2090.6
	1 = Enable setpoint	Motor accelerates with the ramp-up time p1120 to the setpoint.	
7	0 → 1 = Acknowledge faults	Acknowledge fault. If the ON command is still active, the inverter switches to the "switch-on inhibit" state.	p2103[0] = r2090.7
8, 9	Reserved		
10	0 = No control via PLC	Inverter ignores the process data from the fieldbus.	p0854[0] = r2090.10
	1 = Control via PLC	Control via fieldbus, inverter accepts the process data from the fieldbus.	
11	1 = Direction reversal	Invert setpoint in the inverter.	p1113[0] = r2090.11
12	Reserved		
13	1 = MOP up	Increase the setpoint saved in the motorized potentiometer.	p1035[0] = r2090.13
14	1 = MOP down	Reduce the setpoint saved in the motorized potentiometer.	p1036[0] = r2090.14
15	Reserved		

## Status word 1 (ZSW1)

Bit	Meaning	Remarks	Signal inter-connection in the inverter
0	1 = Ready to start	Power supply switched on; electronics initialized; pulses locked.	p2080[0] = r0899.0
1	1 = Ready	Motor is switched on (ON/OFF1 = 1), no fault is active. With the command "Enable operation" (STW1.3), the inverter switches on the motor.	p2080[1] = r0899.1
2	1 = Operation enabled	Motor follows setpoint. See control word 1, bit 3.	p2080[2] = r0899.2
3	1 = Fault active	The inverter has a fault. Acknowledge fault using STW1.7.	p2080[3] = r2139.3
4	1 = OFF2 inactive	Coast down to standstill is not active.	p2080[4] = r0899.4
5	1 = OFF3 inactive	Quick stop is not active.	p2080[5] = r0899.5
6	1 = Switch-on inhibit active	It is only possible to switch on the motor after an OFF1 followed by ON.	p2080[6] = r0899.6
7	1 = Alarm active	Motor remains switched on; no acknowledgement is necessary.	p2080[7] = r2139.7
8	1 = Speed deviation within the tolerance range	Setpoint / actual value deviation within the tolerance range.	p2080[8] = r2197.7
9	1 = Master control requested	The automation system is requested to accept the inverter control.	p2080[9] = r0899.9
10	1 = Comparison speed reached or exceeded	Speed is greater than or equal to the corresponding maximum speed.	p2080[10] = r2199.1
11	1 = Torque limit not reached	Comparison value for current or torque has been fallen below.	p2080[11] = r0056.13 / r1407.7
12	Reserved		p2080[12] = r0899.12
13	0 = Alarm, motor overtemperature	--	p2080[13] = r2135.14
14	1 = Motor rotates clockwise	Internal inverter actual value > 0	p2080[14] = r2197.3
	0 = Motor rotates counterclockwise	Internal inverter actual value < 0	
15	0 = Alarm, inverter thermal overload		p2080[15] = r2135.15

- 1) If you change over from another telegram to telegram 20, then the assignment of the previous telegram is kept.

## Further information

Further information about Modbus RTU is provided in the "Fieldbus" function manual.



Overview of the manuals (Page 507)



## 6.2.11.2 USS

## Settings for USS

Parameter	Explanation		
p2020	<b>Fieldbus interface baudrate</b> (Factory setting: 8)	4: 2400 baud 5: 4800 baud 6: 9600 baud 7: 19200 baud 8: 38400 baud	9: 57600 baud 10: 76800 baud 11: 93750 baud 12: 115200 baud 13: 187500 baud
p2021	<b>Fieldbus interface address</b> (Factory setting: 0) Valid addresses: 0 ... 30. The parameter is only active if address 0 is set at the Control Unit address switch. A change only becomes effective after the inverter power supply has been switched off and switched on again.		
p2022	<b>Fieldbus interface USS PZD number</b> (Factory setting: 2)		
p2023	<b>Fieldbus interface USS PKW number</b> (Factory setting: 127)		0: PKW 0 words 3: PKW 3 words 4: PKW 4 words 127: PKW variable
p2024	<b>Fieldbus interface times</b> (Factory setting: [0] 1000 ms, [1] 0 ms, [2] 0 ms)	[0] Maximum permissible telegram processing time of the Modbus slave [1] Character delay time [2] dead time between two telegrams	
r2029	<b>Fieldbus interface error statistics</b>	[0] number of error-free telegrams [1] number of rejected telegrams [2] number of framing errors [3] number of overrun errors	[4] number of parity errors [5] number of starting character errors [6] number of checksum errors [7] number of length errors
p2030 = 1	<b>Fieldbus interface protocol selection:</b> USS		
p2031	<b>Fieldbus interface Modbus parity</b> (Factory setting: 2)	0: No parity 1: Odd parity 2: Even parity	
p2040	<b>Fieldbus interface monitoring time</b> (Factory setting: 100 ms) p2040 = 0: The monitoring is deactivated		

## Control word 1 (STW1)

Bit	Meaning	Explanation	Signal inter-connection in the inverter
0	0 = OFF1	The motor brakes with the ramp-down time p1121 of the ramp-function generator. The inverter switches off the motor at standstill.	p0840[0] = r2090.0
	0 → 1 = ON	The inverter goes into the "ready" state. If, in addition bit 3 = 1, then the inverter switches on the motor.	
1	0 = OFF2	Switch off the motor immediately, the motor then coasts down to a standstill.	p0844[0] = r2090.1
	1 = No OFF2	The motor can be switched on (ON command).	
2	0 = Quick stop (OFF3)	Quick stop: The motor brakes with the OFF3 ramp-down time p1135 down to standstill.	p0848[0] = r2090.2
	1 = No quick stop (OFF3)	The motor can be switched on (ON command).	
3	0 = Inhibit operation	Immediately switch-off motor (cancel pulses).	p0852[0] = r2090.3
	1 = Enable operation	Switch-on motor (pulses can be enabled).	
4	0 = Disable RFG	The inverter immediately sets its ramp-function generator output to 0.	p1140[0] = r2090.4
	1 = Do not disable RFG	The ramp-function generator can be enabled.	
5	0 = Stop RFG	The output of the ramp-function generator stops at the actual value.	p1141[0] = r2090.5
	1 = Enable RFG	The output of the ramp-function generator follows the setpoint.	
6	0 = Inhibit setpoint	The inverter brakes the motor with the ramp-down time p1121 of the ramp-function generator.	p1142[0] = r2090.6
	1 = Enable setpoint	Motor accelerates with the ramp-up time p1120 to the setpoint.	
7	0 → 1 = Acknowledge faults	Acknowledge fault. If the ON command is still active, the inverter switches to the "switch-on inhibit" state.	p2103[0] = r2090.7
8, 9	Reserved		
10	0 = No control via PLC	Inverter ignores the process data from the fieldbus.	p0854[0] = r2090.10
	1 = Control via PLC	Control via fieldbus, inverter accepts the process data from the fieldbus.	
11	1 = Direction reversal	Invert setpoint in the inverter.	p1113[0] = r2090.11
12	Reserved		
13	1 = MOP up	Increase the setpoint saved in the motorized potentiometer.	p1035[0] = r2090.13
14	1 = MOP down	Reduce the setpoint saved in the motorized potentiometer.	p1036[0] = r2090.14
15	Reserved		

## Status word 1 (ZSW1)

Bit	Meaning	Remarks	Signal inter-connection in the inverter
0	1 = Ready to start	Power supply switched on; electronics initialized; pulses locked.	p2080[0] = r0899.0
1	1 = Ready	Motor is switched on (ON/OFF1 = 1), no fault is active. With the command "Enable operation" (STW1.3), the inverter switches on the motor.	p2080[1] = r0899.1
2	1 = Operation enabled	Motor follows setpoint. See control word 1, bit 3.	p2080[2] = r0899.2
3	1 = Fault active	The inverter has a fault. Acknowledge fault using STW1.7.	p2080[3] = r2139.3
4	1 = OFF2 inactive	Coast down to standstill is not active.	p2080[4] = r0899.4
5	1 = OFF3 inactive	Quick stop is not active.	p2080[5] = r0899.5
6	1 = Switch-on inhibit active	It is only possible to switch on the motor after an OFF1 followed by ON.	p2080[6] = r0899.6
7	1 = Alarm active	Motor remains switched on; no acknowledgement is necessary.	p2080[7] = r2139.7
8	1 = Speed deviation within the tolerance range	Setpoint / actual value deviation within the tolerance range.	p2080[8] = r2197.7
9	1 = Master control requested	The automation system is requested to accept the inverter control.	p2080[9] = r0899.9
10	1 = Comparison speed reached or exceeded	Speed is greater than or equal to the corresponding maximum speed.	p2080[10] = r2199.1
11	1 = Torque limit not reached	Comparison value for current or torque has been fallen below.	p2080[11] = r0056.13 / r1407.7
12	Reserved		p2080[12] = r0899.12
13	0 = Alarm, motor overtemperature	--	p2080[13] = r2135.14
14	1 = Motor rotates clockwise	Internal inverter actual value > 0	p2080[14] = r2197.3
	0 = Motor rotates counterclockwise	Internal inverter actual value < 0	
15	0 = Alarm, inverter thermal overload		p2080[15] = r2135.15

<sup>1)</sup> If you change over from another telegram to telegram 20, then the assignment of the previous telegram is kept.

## Further information

Further information about USS is provided in the "Fieldbus" function manual.



Overview of the manuals (Page 507)

### 6.2.11.3 Ethernet/IP

#### Settings for Ethernet/IP

Parameter	Explanation		
p2030 = 10	<b>Fieldbus interface protocol selection:</b> Ethernet/IP		
p8920	<b>PN Name of Station</b>		
p8921	<b>PN IP address</b> (Factory setting: 0)		
p8922	<b>PN default gateway</b> (factory setting: 0)		
p8923	<b>PN Subnet Mask</b> (Factory setting: 0)		
p8924	<b>PN DHCP mode</b> (Factory setting: 0)	0: DHCP off 2: DHCP on, identification based on MAC address 3: DHCP on, identification based on Name of Station	
p8925	<b>PN interface configuration</b> (Factory setting: 0)	0: No function 1: Reserved 2: Save the configuration and activate 3: Delete configuration	
p8980	<b>Ethernet/IP profile</b> (Factory setting: 0) A change only becomes effective after the inverter power supply has been switched off and switched on again.	0: SINAMICS 1: ODVA AC/DC	
p8982	<b>Ethernet/IP ODVA speed scaling</b> (Factory setting: 128) A change only becomes effective after the inverter power supply has been switched off and switched on again.		
	123: 32	127: 2	131: 0.125
	124: 16	128: 1	132: 0.0625
	125: 8	129: 0.5	133: 0.03125
	126: 4	130: 0.25	

#### Further information

Further information about USS is provided in the "Fieldbus" function manual.



Overview of the manuals (Page 507)

## 6.2.12 Switching over the inverter control (command data set)

In some applications, it must be possible to switch over the master control for operating the inverter.

Example: The motor is to be operable either from a central control via the fieldbus or via the local digital inputs of the inverter.

### Command data set (CDS)

This means that you can set the inverter control in various ways and toggle between the settings. For instance, as described above, the inverter can either be operated via a fieldbus or via its digital inputs.

The settings in the inverter, which are assigned to a specific master control, are termed the command data set.

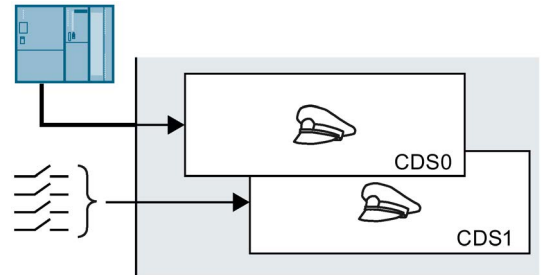

You select the command data set using parameter p0810. To do this, you must interconnect parameter p0810 with a control command of your choice, e.g. a digital input.

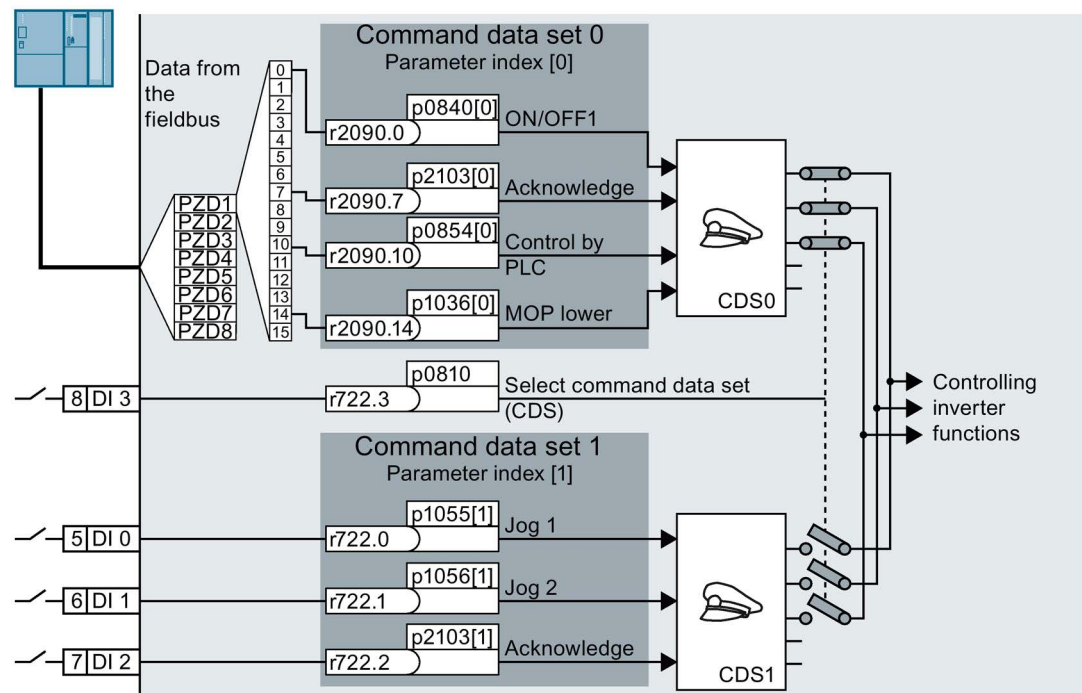

Image 6-18 Example: Switching over the control via terminal strip to control via PROFIBUS or PROFINET

An overview of all the parameters that belong to the command data sets is provided in the List Manual.

**Note**

It takes approximately 4 ms to toggle between command data sets.

**Advanced settings**

To change the number of command data sets in STARTER, you must open your STARTER project offline.

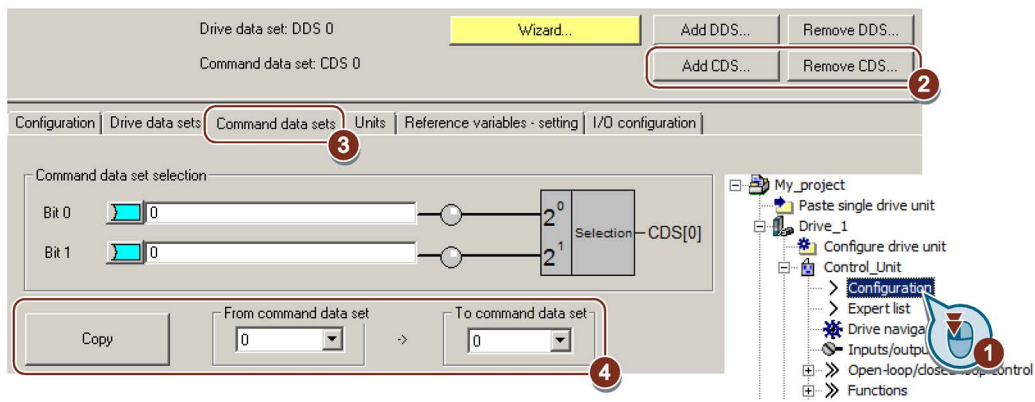

- ① You can edit command data sets if, in the STARTER project tree, you select "Configuration".
- ② If you require more than two command data sets, then add command data sets using this button or remove them.
- ③, ④ To simplify commissioning several command data sets, under the "Command data sets" tab there is a copy function.

Image 6-19 Editing command data sets in STARTER

Parameter	Description
p0010 = 15	<b>Drive commissioning: Data sets</b>
p0170	<b>Number of command data sets</b> (factory setting: 2) p0170 = 2, 3, or 4
p0010 = 0	<b>Drive commissioning: Ready</b>
r0050	<b>Displaying the number of the CDS that is currently active</b>
p0809[0]	<b>Number of the command data set to be copied (source)</b>
p0809[1]	<b>Number of the command data set to which the data is to be copied (target)</b>
p0809[2] = 1	<b>Copying is started</b> Once copying has been completed, the inverter sets p0809[2] to 0.
p0810	<b>Command data set selection CDS bit 0</b>
p0811	<b>Command data set selection CDS bit 1</b>
r0050	<b>Displaying the number of the CDS that is currently active</b>

## 6.3 Setpoints

### 6.3.1 Overview



The inverter receives its main setpoint from the setpoint source. The main setpoint generally specifies the motor speed.

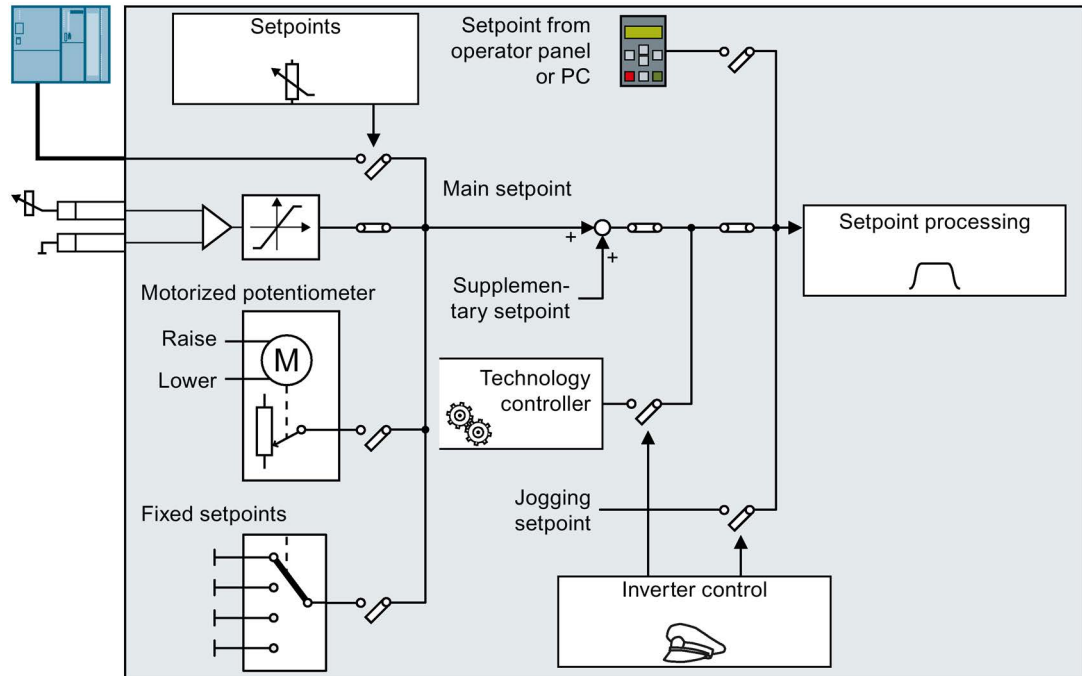

Image 6-20 Setpoint sources for the inverter

You have the following options when selecting the source of the main setpoint:

- Inverter analog input.
- Inverter fieldbus interface.
- Motorized potentiometer simulated in the inverter.
- Fixed setpoints saved in the inverter.

You have the same selection options when selecting the source of the supplementary setpoint.

Under the following conditions, the inverter switches from the main setpoint to other setpoints:

- When the technology controller is active and appropriately interconnected, its output specifies the motor speed.
- When jogging is active.
- When controlling from an operator panel or the STARTER PC tool.

### 6.3.2 Analog input as setpoint source

#### Interconnecting an analog input

If you have selected a pre-assignment without a function of the analog input, then you must interconnect the parameter of the main setpoint with an analog input.

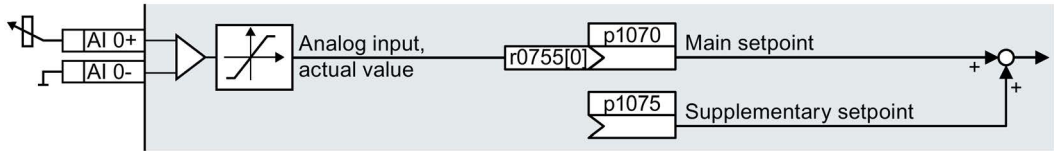



Image 6-21 Example: Analog input 0 as setpoint source

Table 6- 19 Setting with analog input 0 as setpoint source

Parameter	Remark
p1070 = 755[0]	<b>Main setpoint</b> Interconnect the main setpoint with analog input 0
p1075 = 755[0]	<b>Additional setpoint</b> Interconnect the additional setpoint with analog input 0

You must adapt the analog input to the connected signal, e.g.  $\pm 10$  V or 4 ... 20 mA.

 Analog inputs (Page 178)



### 6.3.3 Specifying the setpoint via the fieldbus

#### Interconnecting the fieldbus with the main setpoint

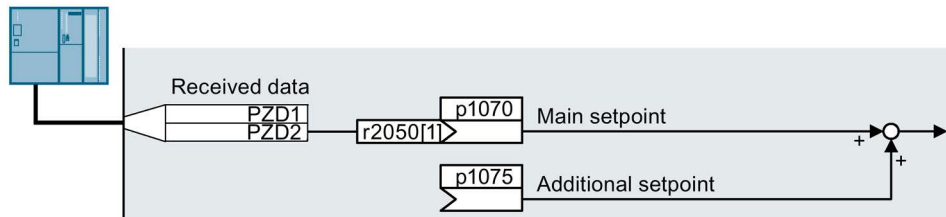

Image 6-22 Fieldbus as setpoint source

Most standard telegrams receive the speed setpoint as a second process data PZD2.

Table 6- 20 Setting the fieldbus as setpoint source

Parameter	Remark
p1070 = 2050[1]	<b>Main setpoint</b> Interconnect the main setpoint with process data PZD2 from the fieldbus.
p1075 = 2050[1]	<b>Additional setpoint</b> Interconnect the additional setpoint with process data PZD2 from the fieldbus.

### 6.3.4 Motorized potentiometer as setpoint source

The "Motorized potentiometer" function emulates an electromechanical potentiometer. The output value of the motorized potentiometer can be set with the "higher" and "lower" control signals.

#### Interconnecting the motorized potentiometer (MOP) with the setpoint source

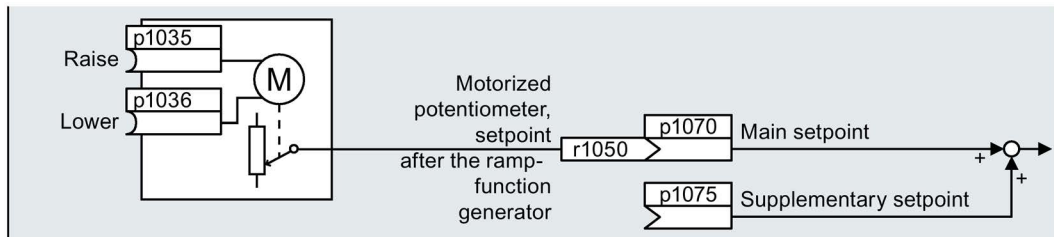

Image 6-23 Motorized potentiometer as setpoint source

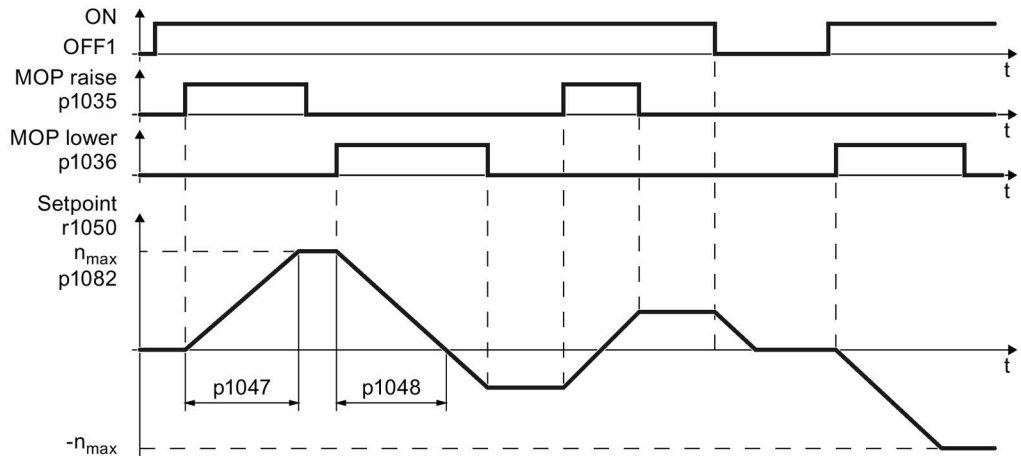

Image 6-24 Function chart of the motorized potentiometer

Table 6- 21 Basic setup of motorized potentiometer

Parameter	Description
p1035	<b>Motorized potentiometer setpoint higher</b>
p1036	<b>Motorized potentiometer setpoint lower</b>
p1040	<b>MOP start value</b> (factory setting: 0 rpm) Defines the start value [rpm] that is effective when the motor is switched on.
p1047	<b>MOP ramp-up time</b> (factory setting: 10 s)
p1048	<b>MOP ramp-down time</b> (factory setting: 10 s)
r1050	<b>Motorized potentiometer setpoint after the ramp-function generator</b>
p1070 = 1050	<b>Main setpoint</b>

Table 6- 22 Extended setup of motorized potentiometer

Parameter	Description
p1030	<b>MOP configuration</b> (factory setting: 00110 bin)
.00	Storage active = 0: After the motor has been switched on, the setpoint = p1040 = 1: After the motor has switched off, the inverter saves the setpoint. After the motor has switched on, the setpoint = the stored value
.01	Automatic mode, ramp-function generator active (1-signal via BI: p1041) = 0: Ramp-up/ramp-down time = 0 = 1: With ramp-function generator In manual mode (p1041 = 0), the ramp-function generator is always active.
.02	Initial rounding active 1: With initial rounding. Using the initial rounding function it is possible to enter very small setpoint changes
.03	Storage in NVRAM active 1: If bit 00 = 1, the setpoint is retained during a power failure
.04	Ramp-function generator always active 1: The inverter also calculates the ramp-function generator when the motor is switched off
p1037	<b>MOP maximum speed</b> (factory setting: 0 rpm) Automatically pre-assigned when commissioning
p1038	<b>MOP minimum speed</b> (factory setting: 0 rpm) Automatically pre-assigned when commissioning
p1039	<b>Motorized potentiometer, inversion</b> (factory setting: 0) Signal source for inverting the minimum speed / velocity or maximum speed / velocity
p1041	<b>Motorized potentiometer, manual/automatic</b> (factory setting: 0) Signal source for switchover from manual to automatic
p1043	<b>Motorized potentiometer, accept setting value</b> (factory setting: 0) Signal source for accepting the setting value. The motorized potentiometer accepts the setting value p1044 on signal change p1043 = 0 → 1.
p1044	<b>MOP setting value</b> (factory setting: 0) Signal source for the setting value.

For more information about the motorized potentiometer, refer to function diagram 3020 in the List Manual.

### 6.3.5 Fixed speed as setpoint source

In many applications after switching on the motor, all that is needed is to run the motor at a constant speed or to switch between different speeds.

Example: After it has been switched on, a conveyor belt only runs with two different velocities.

#### Interconnecting the fixed speeds with a main setpoint

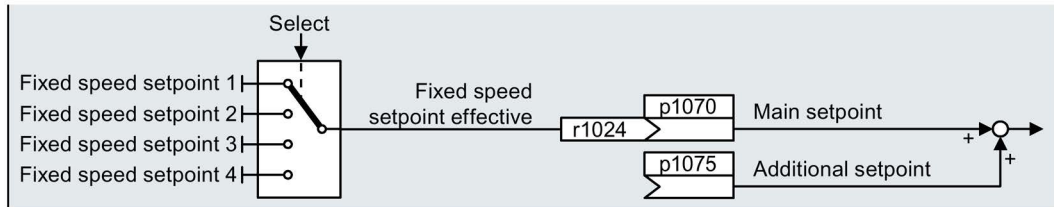

Image 6-25 Fixed speeds as setpoint source

Table 6- 23 Setting the fixed speed as a setpoint source

Parameter	Remark
p1070 = 1024	<b>Main setpoint</b> Interconnecting the main setpoint with fixed speeds.

#### Select fixed setpoint by direct or binary selection

The converter distinguishes between two methods for selecting the fixed setpoints:

1. Direct selection:

You set 4 different fixed setpoints. By adding one or more of the four fixed setpoints, up to 16 different resulting setpoints are obtained.

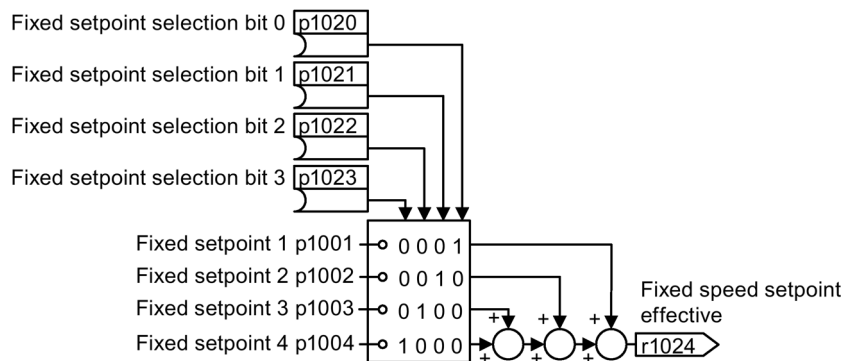

Image 6-26 Simplified function diagram for directly selecting fixed setpoints

Additional information about direct selection can be found in function diagram 3011 in the List Manual.

## 2. Binary selection:

You set 16 different fixed setpoints. You precisely select one of these 16 fixed setpoints by a combination of four selection bits.

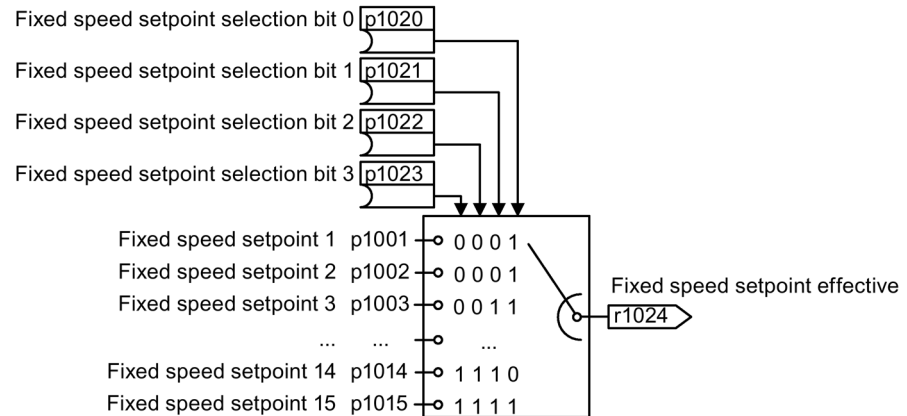

Image 6-27 Simplified function diagram for binary selection of the setpoints

Additional information about binary selection can be found in function diagram 3010 in the List Manual.

## Parameter for setting the fixed setpoints

Parameter	Description
p1001	<b>Fixed speed setpoint 1</b> (factory setting: 0 rpm)
p1002	<b>Fixed speed setpoint 2</b> (factory setting: 0 rpm)
...	...
p1015	<b>Fixed speed setpoint 15</b> (factory setting: 0 rpm)
p1016	<b>Speed fixed setpoint mode</b> (factory setting: 1)
	1: Direct
	2: Binary
p1020	<b>Speed fixed setpoint selection bit 0</b> (factory setting: 0)
p1021	<b>Speed fixed setpoint selection bit 1</b> (factory setting: 0)
p1022	<b>Speed fixed setpoint selection bit 2</b> (factory setting: 0)
p1023	<b>Speed fixed setpoint selection bit 3</b> (factory setting: 0)
r1024	<b>Fixed speed setpoint effective</b>
r1025.0	<b>Fixed speed setpoint status</b>
	1 signal   Fixed speed setpoint is selected

**Example: Select two fixed setpoints directly**

The motor should operate at different speeds as follows:

- The signal on digital input 0 switches the motor on and accelerates it to 300 rpm.
- The signal at digital input 1 accelerates the motor to 2000 rpm.
- The signals at the two digital inputs accelerate the motor to 2300 rpm.

Table 6- 24 Settings for the example

Parameter	Description
p1001 = 300.000	<b>Fixed speed setpoint 1</b> [rpm]
p1002 = 2000.000	<b>Fixed speed setpoint 2</b> [rpm]
p0840 = 722.0	<b>ON/OFF1:</b> Switch on motor with digital input 0
p1070 = 1024	<b>Main setpoint:</b> Interconnect the main setpoint with the fixed speed setpoint.
p1020 = 722.0	<b>Speed fixed setpoint selection Bit 0:</b> Interconnect fixed setpoint 1 with digital input 0 (DI 0).
p1021 = 722.1	<b>Fixed speed setpoint selection bit 1:</b> Interconnects fixed setpoint 2 with digital input 1 (DI 1).
p1016 = 1	<b>Fixed speed setpoint mode:</b> Select direct selection of the fixed setpoints.

Table 6- 25 Resulting fixed setpoints for the example above

Fixed setpoint selected by	Resulting setpoint
DI 0 = 0	Motor stops
DI 0 = 1 and DI 1 = 0	300 rpm
DI 0 = 1 and DI 1 = 1	2300 rpm

## 6.4 Setpoint calculation

### 6.4.1 Overview of setpoint processing



The setpoint can be modified as follows using the setpoint processing:

- Invert setpoint to reverse the motor direction of rotation (reversing).
- Inhibit positive or negative direction of rotation, e.g. for conveyor belts, pumps or fans.
- Skip frequency bands to prevent mechanical resonance effects.

The skip frequency band at speed = 0 results in a minimum speed after switching on the motor.

- Limit to a maximum speed to protect the motor and mechanical system.
- Ramp-function generator to accelerate and brake the motor with an optimum torque.

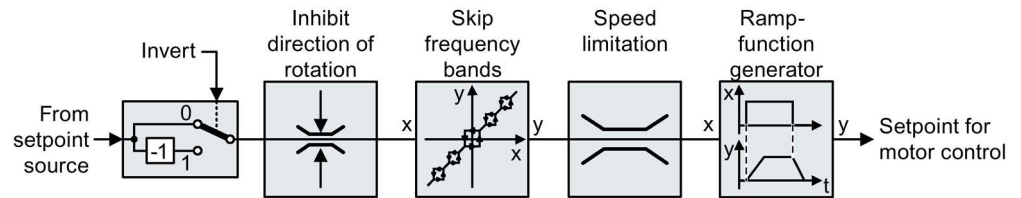
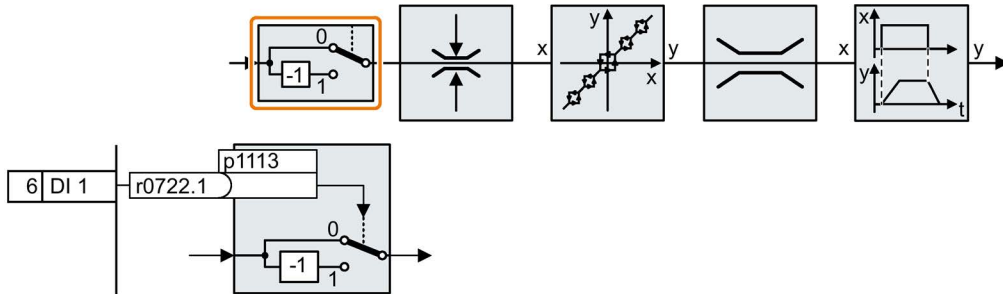

Image 6-28 Setpoint processing in the converter

### 6.4.2 Invert setpoint

The inverter provides an option to invert the setpoint sign using a bit. As an example, the setpoint inversion is shown through a digital input.



In order to invert the setpoint through the digital input DI 1, connect the parameter p1113 with a binary signal, e.g. the digital input 1.

Table 6- 26 Examples of settings to invert the setpoint

Parameter	Remark
p1113 = 722.1	<b>Setpoint inversion</b> Digital input 1 = 0: Setpoint remains unchanged. Digital input 1 = 1: Inverter inverts the setpoint.
p1113 = 2090.11	Invert setpoint via control word 1, bit 11.



### 6.4.3 Inhibit direction of rotation

In the factory setting of the inverter, both motor directions of rotation are enabled.

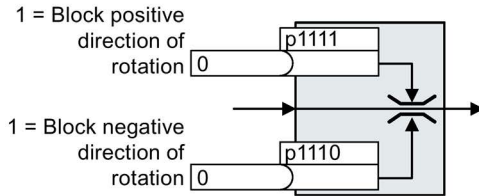
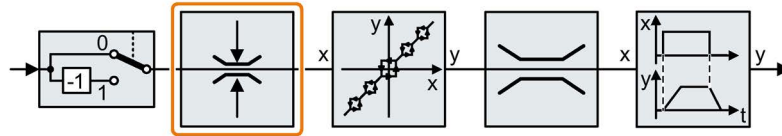

Set the corresponding parameter to a value = 1 to permanently block directions of rotation.

Table 6- 27 Examples of settings to inhibit the direction of rotation

Parameter	Remark
p1110 = 1	<b>Inhibit negative direction</b> Negative direction is permanently inhibited.
p1110 = 722.3	<b>Inhibit negative direction</b> Digital input 3 = 0: Negative direction of rotation is enabled. Digital input 3 = 1: Negative direction of rotation is inhibited.

### 6.4.4 Skip frequency bands and minimum speed

#### Skip frequency bands

The inverter has four skip frequency bands that prevent continuous motor operation within a specific speed range. Further information is provided in function diagram 3050 of the List Manual.

 Manuals and technical support (Page 507)

#### Minimum speed

The inverter prevents continuous motor operation at speeds < minimum speed.

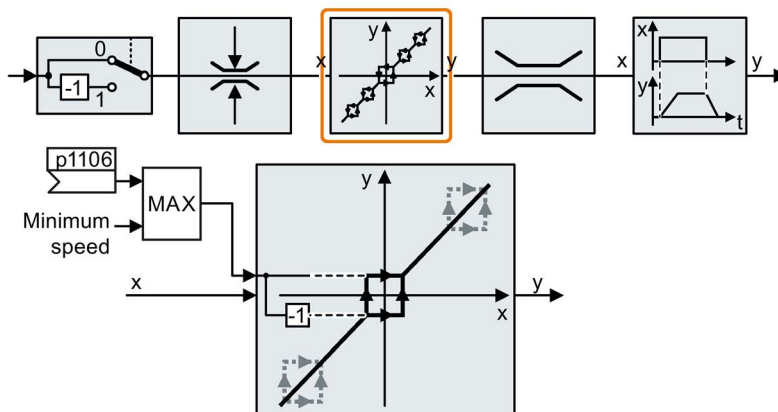

Speeds where the absolute value is less than the minimum speed are only possible during motor operation when accelerating or braking.

Table 6- 28 Setting the minimum speed

Parameter	Description
p1080	<b>Minimum rotation speed</b>  Inverter factory setting (Page 129)
p1106	CI: Minimum speed signal source (factory setting: 0) Dynamic specification of the minimum speed

## 6.4.5 Speed limitation

The maximum speed limits the speed setpoint range for both directions of rotation.

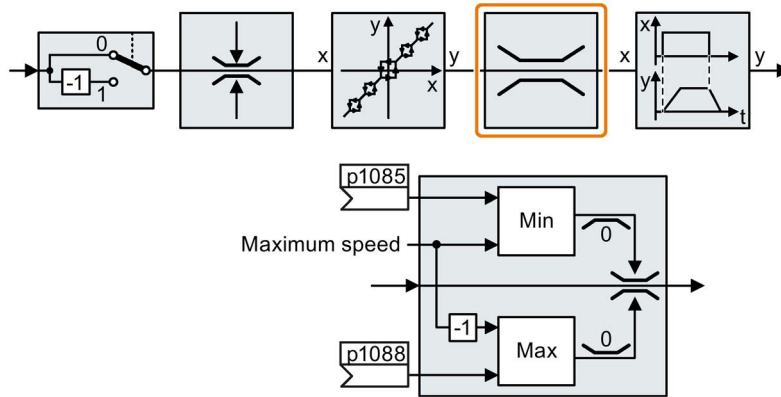

The converter generates a message (fault or alarm) when the maximum speed is exceeded. If you must limit the speed depending on the direction of rotation, then you can define speed limits for each direction.

Table 6- 29 Parameters for the speed limitation

Parameter	Description
p1082	<b>Maximum speed</b> (factory setting: 1500 rpm)
p1083	<b>Speed limit, positive direction of rotation</b> (factory setting: 210,000 rpm)
p1085	<b>CI: Speed limit, positive direction of rotation</b> (factory setting: 1083)
p1086	<b>Speed limit, negative direction of rotation</b> (factory setting: -210,000 rpm)
p1088	<b>CI: Speed limit, negative direction of rotation</b> (factory setting: 1086)

### 6.4.6 Ramp-function generator

The ramp-function generator in the setpoint channel limits the rate of change of the speed setpoint (acceleration). Reduced acceleration lowers the accelerating torque of the motor. In this case, the motor reduces the load on the mechanical system of the driven machine.

You can select between two different ramp-function generator types:

- Extended ramp-function generator

The expanded ramp-function generator limits not only the acceleration but also the change in acceleration (jerk) by rounding the setpoint. In this case, the torque does not rise suddenly in the motor.

- Basic ramp-function generator

The basic ramp-function generator limits the acceleration, however not the rate the acceleration changes (jerk).

#### Extended ramp-function generator

The ramp-up and ramp-down times of the extended ramp-function generator can be set independently of each other. The optimum times that you select depend on your particular application in question and can range from just a few 100 ms (e.g. for belt conveyor drives) to several minutes (e.g. for centrifuges).

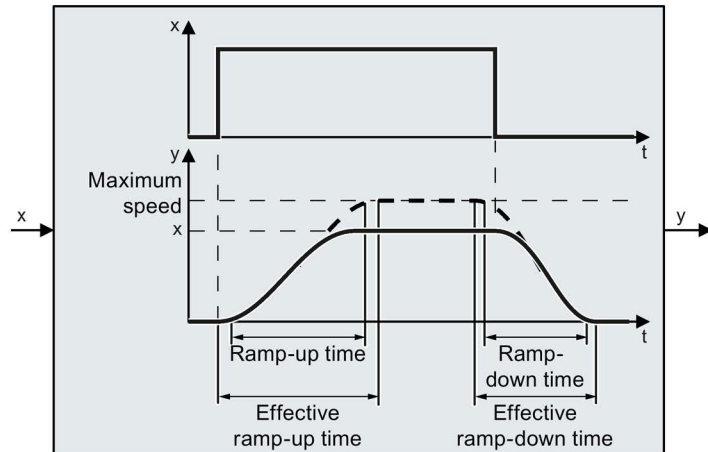
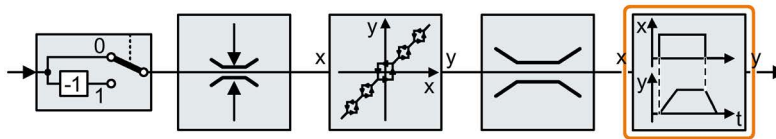

Initial and final rounding permit smooth, jerk-free acceleration and braking.

The ramp-up and ramp-down times of the motor are increased by the rounding times:

- Effective ramp-up time =  $p1120 + 0.5 \times (p1130 + p1131)$ .
- Effective ramp-down time =  $p1121 + 0.5 \times (p1130 + p1131)$ .

Table 6- 30 Additional parameters to set the extended ramp-function generator

Parameter	Description	
p1115	<b>Ramp-function generator selection</b> (factory setting: 1) Select ramp-function generator: 0: Basic ramp-function generator 1: Extended ramp-function generator	
p1120	<b>Ramp-function generator, ramp-up time</b> (factory setting: 10 s) Accelerating time in seconds from zero speed up to the maximum speed p1082	
p1121	<b>Ramp-function generator, ramp-down time</b> (factory setting: 10 s) Braking time in seconds from the maximum speed down to standstill	
p1130	<b>Ramp-function generator initial rounding time</b> (factory setting: 0 s) Initial rounding for the extended ramp-function generator. The value applies for ramp up and ramp down.	
p1131	<b>Ramp-function generator final rounding time</b> (factory setting: 0 s) Final rounding for the extended ramp-function generator. The value applies for ramp up and ramp down.	
p1134	<b>Ramp-function rounding type</b> (factory setting: 0) 0: Continuous smoothing 1: Discontinuous smoothing	
p1135	<b>OFF3 ramp-down time</b> (factory setting 0 s) The quick stop (OFF3) has its own ramp-down time.	
p1136	<b>OFF3 initial rounding time</b> (factory setting: 0 s) Initial rounding for OFF3 for the extended ramp-function generator.	
p1137	<b>OFF3 final rounding time</b> (factory setting: 0 s) Final rounding for OFF3 for the extended ramp-function generator.	

You can find more information in function diagram 3070 and in the parameter list of the List Manual.

### Setting the extended ramp-function generator

#### Procedure



1 Proceed as follows to set the extended ramp-function generator:

1. Enter the highest possible speed setpoint.
2. Switch on the motor.
3. Evaluate your drive response.
  - If the motor accelerates too slowly, then reduce the ramp-up time.  
An excessively short ramp-up time means that the motor will reach its current limiting when accelerating, and will temporarily not be able to follow the speed setpoint. In this case, the drive exceeds the set time.
  - If the motor accelerates too fast, then extend the ramp-up time.
  - Increase the initial rounding if the acceleration is jerky.
  - We recommend that you set the final rounding to the same value as the initial rounding.
4. Switch off the motor.
5. Evaluate your drive response.
  - If the motor decelerates too slowly, then reduce the ramp-down time.  
The minimum ramp-down time that makes sense depends on your particular application. Depending on the Power Module used, for an excessively short ramp-down time, the converter either reaches the motor current, or the DC link voltage in the converter becomes too high. Depending on the converter setting, the real braking time exceeds the set ramp-down time, or the converter goes into a fault condition when braking.
  - Extend the ramp-down time if the motor is braked too quickly or the converter goes into a fault condition when braking.
6. Repeat steps 1 ... 5 until the drive behavior meets the requirements of the machine or plant.

You have set the extended ramp-function generator.

## Basic ramp-function generator

When compared to the extended ramp-function generator, the basic ramp-function generator has no rounding times.

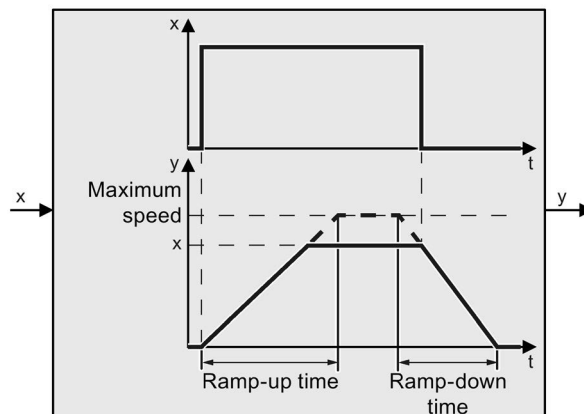

Table 6- 31 Parameters for setting the ramp-function generator

Parameter	Description
p1115 = 0	<b>Ramp-function generator selection</b> (factory setting: 1) Select ramp-function generator: 0: Basic ramp-function generator 1: Extended ramp-function generator
p1120	<b>Ramp-function generator, ramp-up time</b> (factory setting: 10 s) Accelerating time in seconds from zero speed up to the maximum speed p1082
p1121	<b>Ramp-function generator, ramp-down time</b> (factory setting: 10 s) Braking time in seconds from the maximum speed down to standstill
p1135	<b>OFF3 ramp-down time</b> (factory setting: 0 s) The quick stop (OFF3) has its own ramp-down time.

## Changing the ramp-up and ramp-down times in operation

The ramping up and down time of the ramp-function generator can be changed during operation. The scaling value can come, e.g. from the fieldbus.

Table 6- 32 Parameters for setting the scaling

Parameter	Description
p1138	<b>Up ramp scaling</b> (factory setting: 1) Signal source for scaling the acceleration ramp.
p1139	<b>Deceleration ramp scaling</b> (factory setting: 1) Signal source for scaling the deceleration ramp.

**Example**

In the following example, the higher-level control sets the ramp-up and ramp-down times of the inverter via PROFIBUS.

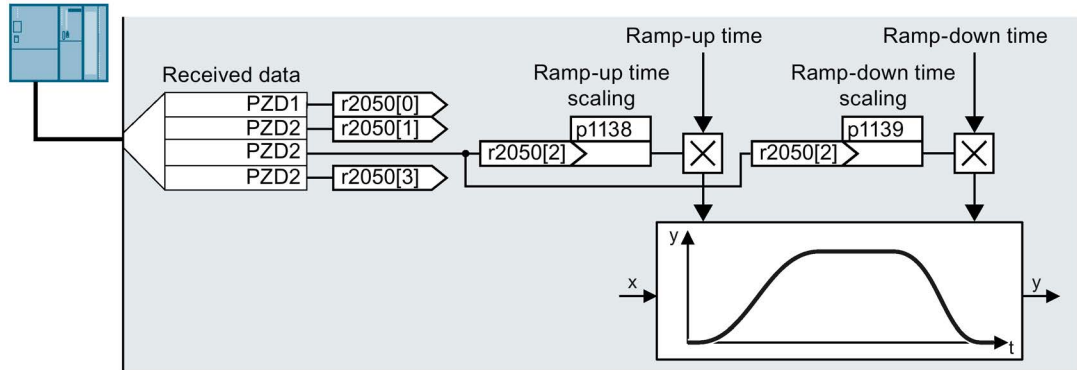

Image 6-29 Example for changing the ramp-function generator times in operation

**Preconditions**

- You have commissioned the communication between the inverter and the control system.
- Free telegram 999 has been set in the inverter and in your higher-level control system.
- ➡ Extend telegrams and change signal interconnection (Page 206)
- The control sends the scaling value to the inverter in PZD 3.

**Procedure**



1 To interconnect the scaling of the ramp-up and ramp-down times with PZD receive word 3 from the fieldbus in the inverter, proceed as follows:

1. Set p1138 = 2050[2].

This means that you have interconnected the scaling factor for the ramp-up time with PZD receive word 3.

2. Set p1139 = 2050[2].

This means that you have interconnected the scaling factor for the ramp-down time with PZD receive word 3.



The inverter receives the value for scaling the ramp-up and ramp-down times via PZD receive word 3.



Further information is provided in the Internet:

FAQ (<https://support.industry.siemens.com/cs/ww/en/view/82604741>)



## 6.5 Motor control



The inverter has two alternative methods to control (closed loop) the motor speed:

- U/f control
- Vector control with speed controller

### 6.5.1 V/f control

#### Overview of the U/f control

The U/f control is a closed-loop speed control with the following characteristics:

- The inverter controls the output voltage using the V/f characteristic
- The output frequency is essentially calculated from the speed setpoint and the number of pole pairs of the motor
- The slip compensation corrects the output frequency depending on the load and thus increases the speed accuracy
- Not using a PI controller prevents the speed control from becoming unstable
- In applications in which greater speed accuracy is required, a closed-loop control with load-dependent voltage boost can be selected (flux current control, FCC)

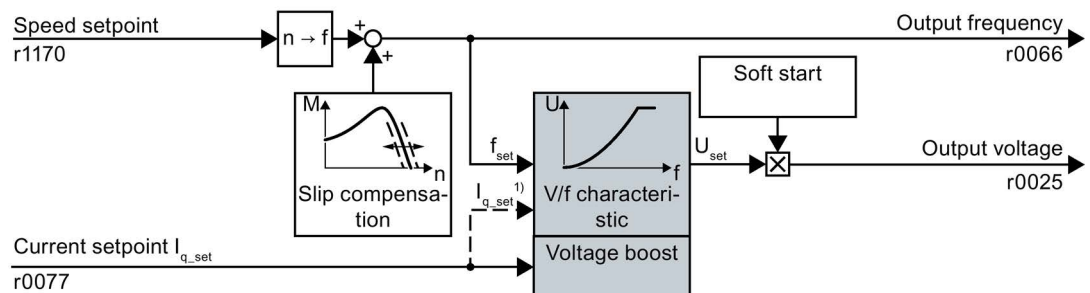

- 1) In the U/f control variant, "flux current control (FCC)," the inverter controls the motor current (starting current) at low speeds

Image 6-30 Simplified function diagram of the U/f control

One function not shown in the simplified function diagram is the resonance damping for damping mechanical oscillations. You will find the complete function diagrams 6300 et seq. in the List Manual.

For operation of the motor with U/f control, you must set at least the subfunctions shown with a gray background in the figure to adapt them to your application:

- V/f characteristic
- Voltage boost

**Default setting after selecting the application class Standard Drive Control**

Selecting application class Standard Drive Control in the quick commissioning adapts the structure and the setting options of the U/f control as follows:

- Starting current closed-loop control: At low speeds, a controlled motor current reduces the tendency of the motor to oscillate.
- With increasing speed, transition from closed-loop starting current control into U/f control with voltage boost depending on the load.
- Soft starting is not possible.
- Fewer parameters

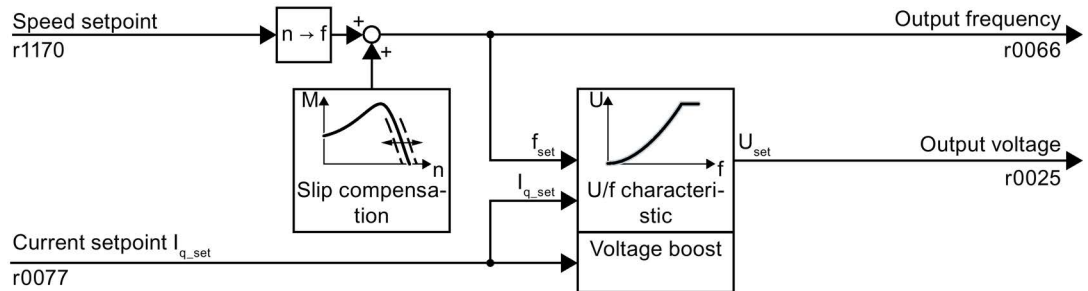
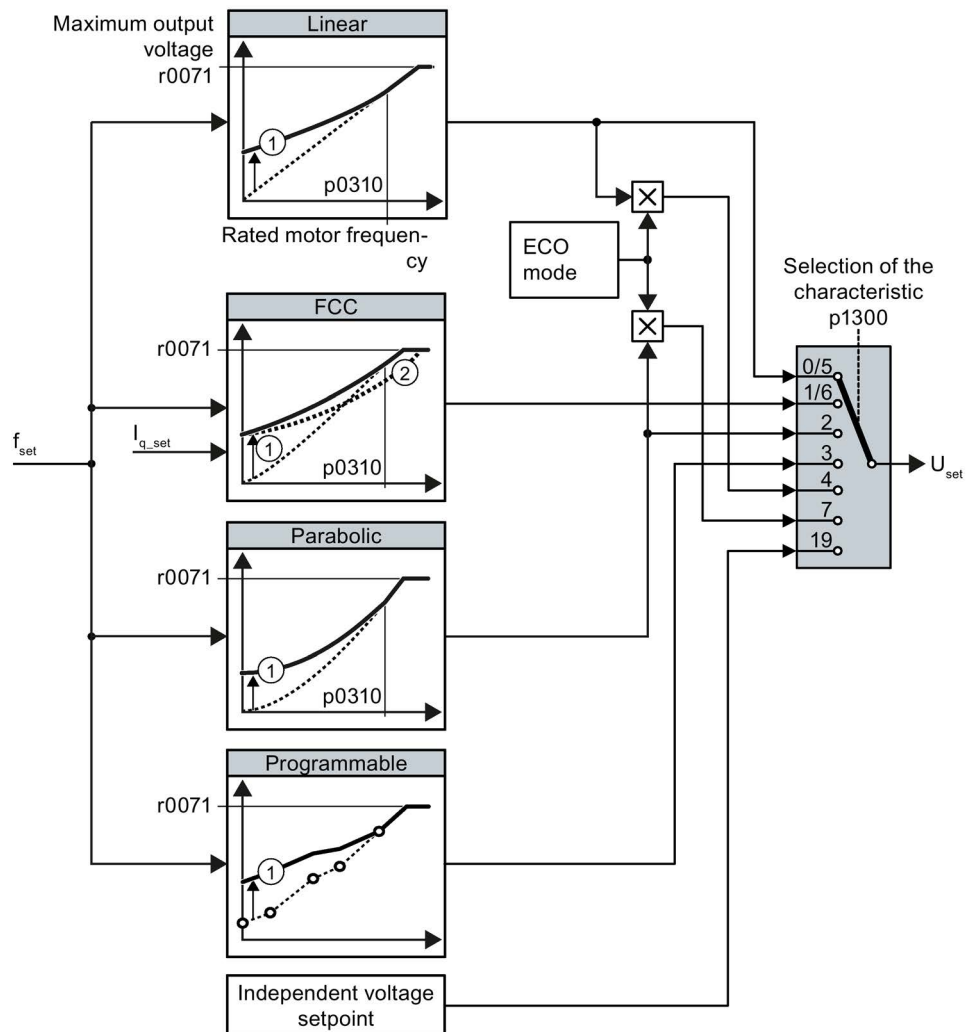

Image 6-31 Default setting of the U/f control after selecting Standard Drive Control

The complete function diagrams 6850 ff. for application class Standard Drive Control are provided in the List Manual.

### 6.5.1.1 Characteristics of U/f control

The inverter has different V/f characteristics.



- ① The voltage boost of the characteristic optimizes the speed control at low speeds
- ② With the flux current control (FCC), the inverter compensates for the voltage drop in the stator resistor of the motor

Image 6-32 Characteristics of V/f control

The inverter increases its output voltage to the maximum possible output voltage. The maximum possible output voltage of the inverter depends on the line voltage.

When the maximum output voltage is reached, the inverter only increases the output frequency. At this point, the motor enters the field weakening range: At constant torque, the slip decreases quadratically as the speed increases.

The value of the output voltage at the rated motor frequency also depends on the following variables:

- Ratio between the inverter size and the motor size
- Line voltage
- Line impedance
- Actual motor torque

The maximum possible output voltage as a function of the input voltage is provided in the technical data.

 Technical data (Page 423)

Table 6- 33 Linear and parabolic characteristics

Requirement	Application examples	Remark	Characteristic	Parameter
The required torque is independent of the speed	Conveyor belts, roller conveyors, chain conveyors, eccentric worm pumps, compressors, extruders, centrifuges, agitators, mixers	-	Linear	p1300 = 0
		The inverter equalizes the voltage drops across the stator resistance. Recommended for motors less than 7.5 kW. Precondition: You have set the motor data according to the rating plate and have performed the motor identification after quick commissioning.	Linear with Flux Current Control (FCC)	p1300 = 1
The required torque increases with the speed	Centrifugal pumps, radial fans, axial fans	Lower losses in the motor and inverter than for a linear characteristic.	Parabolic	p1300 = 2

Table 6- 34 Characteristics for special applications

Requirement	Application examples	Remark	Characteristic	Parameter
Applications with a low dynamic response and constant speed	Centrifugal pumps, radial fans, axial fans	The ECO mode results in additional energy saving when compared to the parabolic characteristic. If the speed setpoint is reached and remains unchanged for 5 seconds, the inverter again reduces its output voltage.	ECO mode	p1300 = 4 or p1300 = 7
The inverter must keep the motor speed constant under all circumstances.	Drives in the textile sector	When the maximum current limit is reached, the inverter only reduces the stator voltage but not the speed.	Precise frequency characteristic	p1300 = 5 or p1300 = 6
Freely adjustable U/f characteristic	-	-	Adjustable characteristic	p1300 = 3
U/f characteristic with independent voltage setpoint	-	The interrelationship between the frequency and voltage is not calculated in the inverter, but is specified by the user.	Independent voltage setpoint	p1300 = 19

Additional information on U/f characteristics can be found in the parameter list and in the function diagrams 6300 ff of the List Manual.

## Characteristics after selecting the application class Standard Drive Control

Selecting application class Standard Drive Control reduces the number of characteristics and the setting options:

- A linear and a parabolic characteristic are available.
- Selecting a technological application defines the characteristic.
- The following cannot be set - ECO mode, FCC, the programmable characteristic and a specific voltage setpoint.

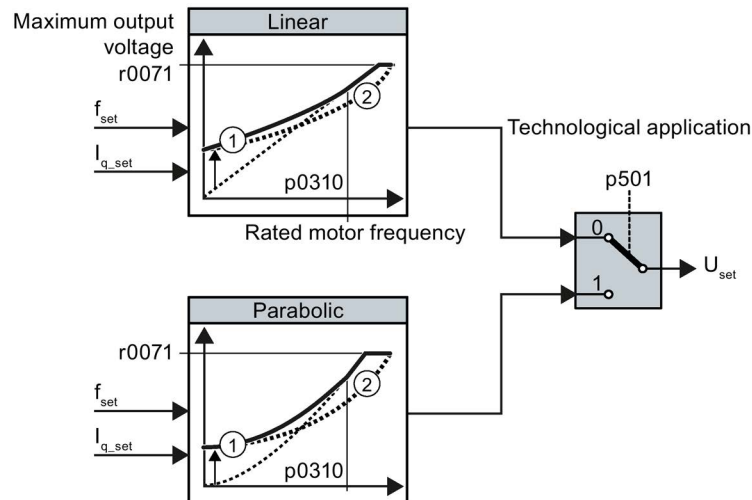

- ① The closed-loop starting current control optimizes the speed control at low speeds
- ② The inverter compensates the voltage drop across the motor stator resistance

Image 6-33 Characteristics after selecting Standard Drive Control

Table 6- 35 Linear and parabolic characteristics

Requirement	Application examples	Remark	Characteristic	Parameter
The required torque is independent of the speed	Conveyor belts, roller conveyors, chain conveyors, eccentric worm pumps, compressors, extruders, centrifuges, agitators, mixers	-	Linear	p0501 = 0
The required torque increases with the speed	Centrifugal pumps, radial fans, axial fans	Lower losses in the motor and inverter than for a linear characteristic.	Parabolic	p0501 = 1

Additional information on the characteristics can be found in the parameter list and in the function diagrams 6851 ff of the List Manual.

### 6.5.1.2 Optimizing motor starting

#### Setting the voltage boost for U/f control

After selection of the V/f characteristic, no further settings are required in most applications.

In the following circumstances, the motor cannot accelerate to its speed setpoint after it has been switched on:

- Load moment of inertia too high
- Load torque too large
- Ramp-up time p1120 too short

To improve the starting behavior of the motor, the V/f characteristic can be raised at low speeds.

The inverter raises the voltage in accordance with the starting currents p1310 ... p1312.

The adjacent diagram shows the resulting voltage boost using a linear characteristic as an example.

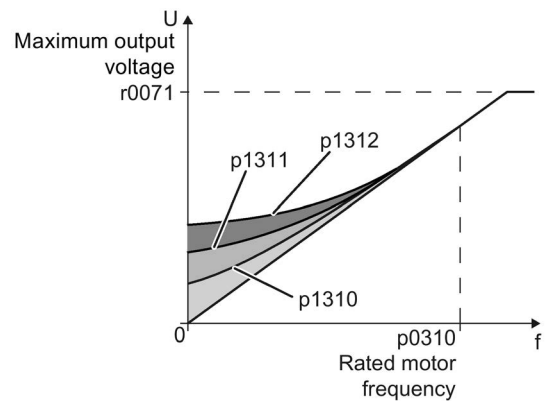

#### Requirements

- Set the ramp-up time of the ramp-function generator to a value 1 s (< 1 kW) ... 10 s (> 10 kW), depending on the power rating of the motor .
- Increase the starting current in steps of ≤ 5 %. Excessively high values in p1310 ... p1312 can cause the motor to overheat and switch off (trip) the inverter due to overcurrent.

If the message A07409 appears, you must not increase any of the parameters.

#### Procedure



Proceed as follows to set the voltage boost:

1. Switch off the motor with a setpoint of just a few revolutions per minute.
2. Check whether the motor rotates smoothly.
3. If the motor rotates eccentrically or even stops, increase the voltage boost p1310 until the motor rotates smoothly.

4. Accelerate the motor to the maximum speed with maximum load.
5. Check whether the motor is following the setpoint.
6. If necessary, increase the voltage boost p1311 until the motor accelerates without problem.

In applications with a high break loose torque, you must additionally set parameter p1312 higher to achieve a satisfactory response.

- You have set the voltage boost.

Parameter	Description
p1310	<b>Starting current (voltage boost) permanent</b> (factory setting 50 %) Compensates for voltage drops caused by long motor cables and the ohmic losses in the motor.
p1311	<b>Starting current (voltage boost) when accelerating</b> (factory setting 0 %) Provides additional torque when the motor accelerates.
p1312	<b>Starting current (voltage boost) when starting</b> (factory setting 0 %) Provides additional torque, however, only when the motor accelerates for the first time after it has been switched on ("break loose torque").

You will find more information on this function in the parameter list and in function diagram 6301 in the List Manual.

## Starting current (boost) after selecting the application class Standard Drive Control

After selecting application class Standard Drive Control, in most applications, and no additional settings have to be made.

At standstill, the inverter ensures that at least the rated motor magnetizing current flows. Magnetizing current p0320 approximately corresponds to the no-load current at 50 % ... 80 % of the rated motor speed.

In the following situations, after it has been switched on, the motor cannot accelerate up to its speed setpoint:

- Excessively high load moment of inertia
- Excessively high load torque
- Ramp-up time p1120

The current can be increased at low speeds to improve the starting behavior of the motor.

The inverter boosts the voltage corresponding to the starting currents p1310 ... p1312.

The adjacent diagram shows the voltage boost using a linear characteristic as example.

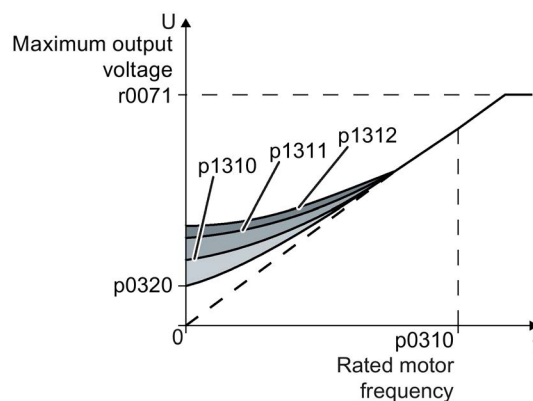

### Requirements

- Depending on the rated power of the motor, set the ramp-up time of the ramp-function generator to a value of 1 s (< 1 kW) ... 10 s (> 10 kW).
- Increase the starting current in steps of  $\leq 5\%$ . Excessively high values in p1310 ... p1312 can cause the motor to overheat and switch off (trip) the inverter due to overcurrent.

When message A07409 is displayed, it is not permissible that you further increase the value of any of the parameters.

### Procedure



Proceed as follows to set the voltage boost:

1. Switch on the motor with a setpoint of a few revolutions per minute.
2. Check whether the motor rotates smoothly.
3. If the motor does not rotate smoothly, or even remains stationary, increase the voltage boost p1310 until the motor runs smoothly.



4. Accelerate the motor to the maximum speed with maximum load.
5. Check that the motor follows the setpoint.
6. When required, increase the voltage boost p1311 until the motor accelerates without any problem.

In applications with a high break loose torque, you must also increase parameter p1312 in order to achieve a satisfactory motor response.

- You have set the voltage boost.

Parameter	Description
p1310	<b>Starting current (voltage boost) permanent</b> (Factory setting 50 %) Compensates voltage losses as a result of long motor cables and the ohmic losses in the motor. After commissioning, depending on the motor power rating and the technological application p0501, the inverter sets p1310.
p1311	<b>Starting current (voltage boost) when accelerating</b> (Factory setting 0%) Provides additional torque when the motor accelerates. After commissioning, depending on the motor power rating and the technological application p0501, the inverter sets p1311.
p1312	<b>Starting current (voltage boost) when starting</b> (Factory setting 0%) Provides additional torque, however, only when the motor accelerates for the first time after it has been switched on ("break loose torque").

You can find more information about this function in the parameter list and in function diagram 6851 of the List Manual.

## 6.5.2 Vector control with speed controller

### 6.5.2.1 Overview

#### Overview

The vector control comprises closed-loop current control and a higher-level closed-loop speed control.

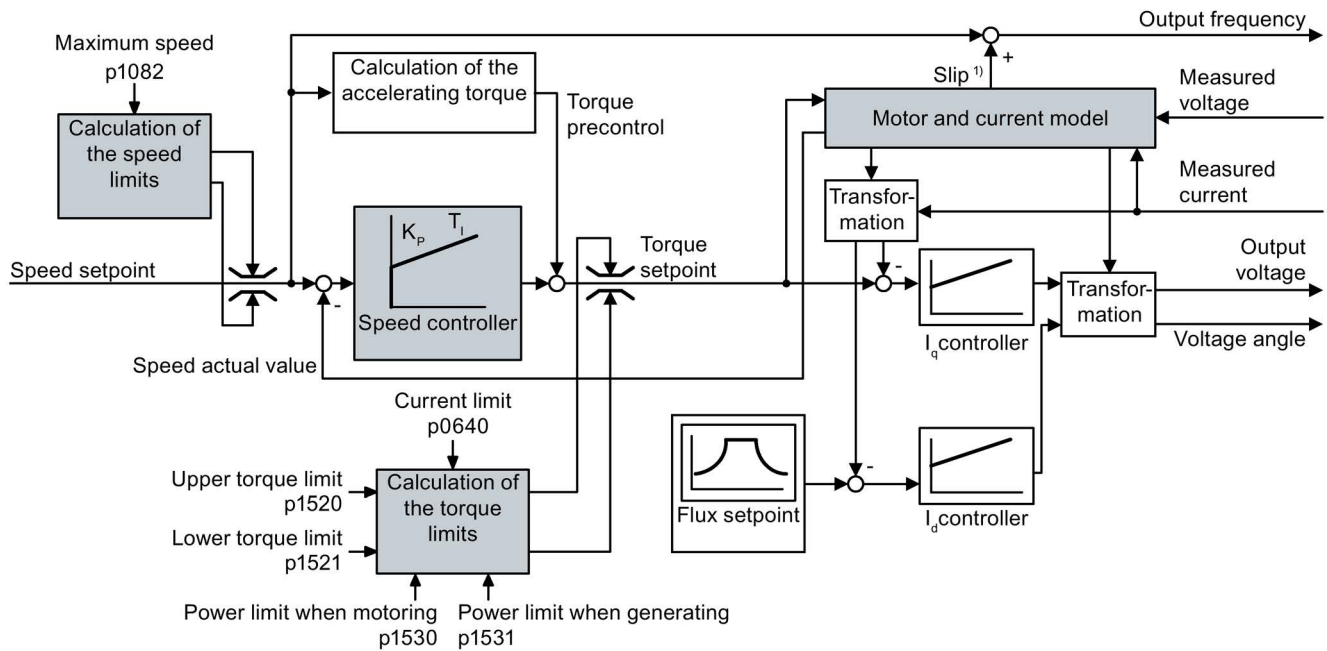

1) For induction motors

Image 6-34 Simplified function diagram for sensorless vector control with speed controller

All of the function block diagrams 6020 ff. for vector control are provided in the List Manual:

Using the motor model, the inverter calculates the following closed-loop control signals from the measured phase currents and the output voltage:

- Current component  $I_d$
- Current component  $I_q$
- Speed actual value

The setpoint of the current component  $I_d$  (flux setpoint) is obtained from the motor data. For speeds above the rated speed, the inverter reduces the flux setpoint along the field weakening characteristic.

When the speed setpoint is increased, the speed controller responds with a higher setpoint for the current component  $I_q$  (torque setpoint). The closed-loop control responds to a higher torque setpoint by adding a higher slip frequency to the output frequency. Also in the motor, the higher output frequency results in a higher slip, which is proportional to the accelerating

torque.  $I_q$  and  $I_d$  controllers keep the motor flux constant using the output voltage, and adjust the matching current component  $I_q$  in the motor.

In order to achieve a satisfactory controller response, as a minimum, you must match the subfunctions having a gray background as shown in the diagram above with your particular application.

- **Motor and current model:** In the quick commissioning, correctly set the motor data on the rating plate corresponding to the connection type (Y/Δ), and carry out the motor data identification routine at standstill.
- **Speed limits and torque limits:** In the quick commissioning, set the maximum speed (p1082) and current limit (p0640) to match your particular application. When exiting quick commissioning, the inverter calculates the torque and power limits corresponding to the current limit. The actual torque limits are obtained from the converted current and power limits and the set torque limits.
- **Speed controller:** Start the rotating measurement of the motor data identification. You must manually optimize the controller if the rotating measurement is not possible.

### Default settings after selecting the application class Dynamic Drive Control

Selecting application class Dynamic Drive Control in the quick commissioning adapts the structure of the vector control, and reduces the setting options:

	Vector control after selecting the application class Dynamic Drive Control	Vector control without selecting an application class
Closed-loop torque control without higher-level speed controller	Not possible	Possible
Droop	Not possible	Possible
$K_P$ - and $T_I$ adaptation	Simplified	Advanced
Hold or set the integral component of the speed controller	Not possible	Possible
Acceleration model for precontrol	Default setting	Can be activated
Motor data identification at standstill or with rotating measurement	Shortened, with optional transition into operation	Complete

### 6.5.2.2 Optimizing the closed-loop speed controller

#### Optimum control response - post optimization not required

Preconditions for assessing the controller response:

- The moment of inertia of the load is constant and does not depend on the speed
- The inverter does not reach the set torque limits during acceleration
- You operate the motor in the range 40 % ... 60 % of its rated speed

If the motor exhibits the following response, the speed control is well set and you do not have to adapt the speed controller manually:

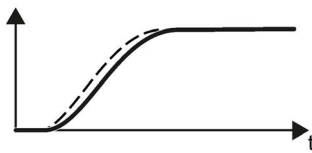

The speed setpoint (broken line) increases with the set ramp-up time and rounding.

The actual value follows the setpoint without overshooting.

#### Control optimization required

In some cases, the self-optimization result is not satisfactory or self-optimization is not possible because the motor cannot rotate freely.

In these cases, you must optimize the closed-loop speed control manually. The following parameters influence the response of the speed control:

- p1496 Acceleration pre-control scaling
- p0342 Ratio between the total and motor moment of inertia
- p1470 P gain  $K_P$
- p1472 Integration time (integral time)  $T_I$
- p1452 Speed controller actual speed value smoothing time (without encoder)

#### Optimizing the speed controller

##### Requirements

- Torque precontrol is active: p1496 = 100 %.
- The load moment of inertia is constant and independent of the speed.
- The inverter requires 10 % ... 50 % of the rated torque to accelerate.

When necessary, adapt the ramp-up and ramp-down times of the ramp-function generator (p1120 and p1121).

- You have prepared the trace function in STARTER or Startdrive to be able to trace the speed setpoint and the speed actual value.

**Procedure**

To optimize the speed controller, proceed as follows:

1. Switch on the motor.
2. Enter a speed setpoint of approximately 40 % of the rated speed.
3. Wait until the actual speed has stabilized.
4. Increase the setpoint up to a maximum of 60 % of the rated speed.
5. Monitor the associated characteristic of the setpoint and actual speed.
6. Optimize the controller by adapting the ratio of the moments of inertia of the load and motor (p0342):

	<p>Initially, the actual speed follows the setpoint speed; however, it then overshoots the setpoint speed.</p> <ul style="list-style-type: none"> <li>• Increase p0342</li> </ul>
	<p>Initially, the actual speed exceeds the setpoint speed; however, it does not overshoot but instead approaches the setpoint speed "from below".</p> <ul style="list-style-type: none"> <li>• Reduce p0342</li> </ul>

7. Switch off the motor.
8. Start a new calculation of the speed controller: p0340 = 4.
9. Switch on the motor.
10. Over the complete speed range check whether the speed control responds satisfactorily with the optimized settings.

■ You have optimized the speed controller.

When necessary, set the ramp-up and ramp-down times of the ramp-function generator (p1120 and p1121) back to the value before optimization.

**Mastering critical applications**

The drive control can become unstable for drives with a high load moment of inertia and gearbox backlash or a coupling between the motor and load that can possibly oscillate. In this case, we recommend the following settings:

- Increase the smoothing of speed actual value p1452.
- Increase the integral time:  $T_I \geq 4 \times p1452$ .
- If the closed-loop speed control no longer has an adequate dynamic performance after these measures, then increase the P gain  $K_P$  step-by-step.

### 6.5.2.3 Advanced settings

#### K<sub>p</sub>- and T<sub>i</sub>adaptation

K<sub>p</sub> and T<sub>i</sub> adaptation suppress speed control oscillations that may occur. The "rotating measurement" of the motor data identification optimizes the speed controller. If you have performed the rotating measurement, then the K<sub>p</sub>- and T<sub>i</sub>adaptation has been set.

You can find additional information in the List Manual:

- Vector control with speed controller: Function diagram 6050
- Vector control after presetting the application class Dynamic Drive Control Function diagram 6824

#### Droop

For mechanically coupled drives, there is the risk that the drives oppose one another: Small deviations in the speed setpoint or actual value of the coupled drives can mean that the drives are operated with significantly different torques.

The droop function ensures even torque distribution between several mechanically coupled drives.

The droop function reduces the speed setpoint as a function of the torque setpoint.

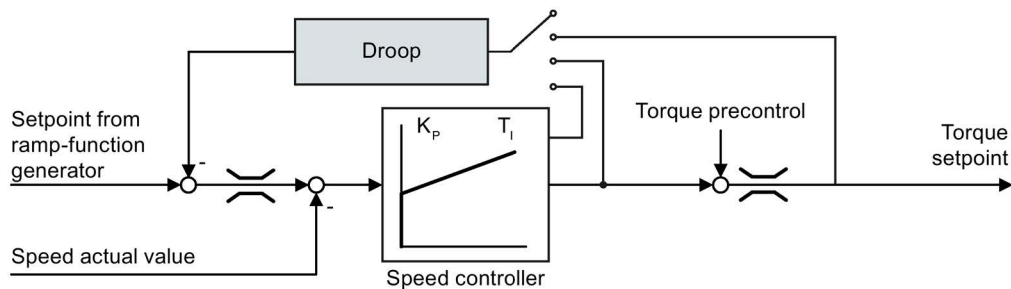

Image 6-35 Effect of droop in the speed controller

When droop is active, the ramp-function generators of all of the coupled drives must be set to have identical ramp-up and ramp-down times as well as rounding-off.

Par.	Explanation
r1482	<b>Speed controller   torque output</b>
p1488	<b>Droop input source</b> (factory setting: 0) 0: Droop feedback not connected 1: Droop from the torque setpoint 2: Droop from the speed control output 3: Droop from the integral output, speed controller
p1489	<b>Droop feedback scaling</b> (factory setting: 0.05) A value of 0.05 means: At the rated motor torque, the inverter reduces the speed by 5% of the rated motor speed.
r1490	<b>Droop feedback speed reduction</b>
p1492	<b>Droop feedback enable</b> (factory setting: 0)

After selecting application class "Dynamic Drive Control", droop is no longer possible.

You can find additional information in the List Manual, function block diagram 6030.

### 6.5.2.4 Friction characteristic

#### Function

In many applications, e.g. applications with geared motors or belt conveyors, the frictional torque of the load is not negligible.

The inverter provides the possibility of precontrolling the torque setpoint, bypassing the speed controller. The precontrol reduces overshooting of the speed after speed changes.

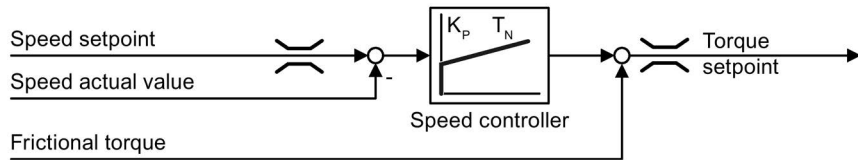

Image 6-36 Precontrol of the speed controller with frictional torque

The inverter calculates the current frictional torque from a friction characteristic with 10 intermediate points.

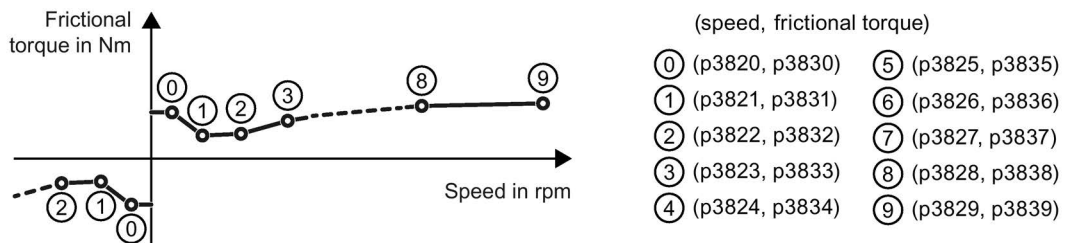

Image 6-37 Friction characteristic

The intermediate points of the friction characteristic are defined for positive speeds. In the negative direction of rotation, the inverter uses the intermediate points with a negative sign.

#### Recording a friction characteristic

After quick commissioning, the inverter sets the speeds of the intermediate points to values suitable for the rated speed of the motor. The frictional torque of all intermediate points is still equal to zero. On request, the inverter records the friction characteristic: The inverter accelerates the motor step by step up to the rated speed, measures the frictional torque and writes the frictional torque into the intermediate points of the friction characteristic.

#### Requirement

The motor is permitted to accelerate up to the rated speed without endangering persons or property.



#### Procedure

To record the friction characteristic, proceed as follows:

1. Set P3845 = 1: The inverter accelerates the motor successively in both directions of rotation and averages the measurement results of the positive and negative directions.



2. Switch on the motor (ON/OFF1 = 1).
3. The inverter accelerates the motor.

During measurement, the inverter signals the alarm A07961.

When the inverter has determined all the intermediate points of the friction characteristic without fault code F07963, the inverter stops the motor.

- You have recorded the friction characteristic.

### Adding friction characteristic for the torque setpoint

If you enable the friction characteristic (p3842 = 1), the inverter adds the output of the friction characteristic r3841 to the torque setpoint.

### Parameter

Parameter	Explanation
p3820 ... p2839	Intermediate points of the friction characteristic [rpm; Nm]
r3840	<b>Friction characteristic status word</b>
	.00 1 signal: Friction characteristic OK
	.01 1 signal: Determination of the friction characteristic is active
	.02 1 signal: Determination of the friction characteristic is complete
	.03 1 signal: Determination of the friction characteristic has been aborted
	.08 1 signal: Friction characteristic positive direction
r3841	<b>Friction characteristic, output [Nm]</b>
p3842	<b>Activate friction characteristic</b> 0: Friction characteristic deactivated 1: Friction characteristic activated
p3845	<b>Activate friction characteristic plot</b> (factory setting: 0) 0: Friction characteristic plot deactivated 1: Friction characteristic plot activated, both directions 2: Friction characteristic plot activated, positive direction 3: Friction characteristic plot activated, negative direction
p3846	<b>Friction characteristic plot ramp-up/ramp-down time</b> (factory setting: 10 s) Ramp-up/ramp-down time for automatic plotting of the friction characteristic.
p3847	<b>Friction characteristic plot warm-up period</b> (factory setting: 0 s) At the start of automatic plotting, the inverter accelerates the motor up to the speed = p3829 und keeps the speed constant for this time.

You will find more information in the List Manual.

### 6.5.2.5 Moment of inertia estimator

#### Background

From the load moment of inertia and the speed setpoint change, the inverter calculates the accelerating torque required for the motor. Via the speed controller precontrol, the accelerating torque specifies the main percentage of the torque setpoint. The speed controller corrects inaccuracies in the precontrol (feed-forward control).

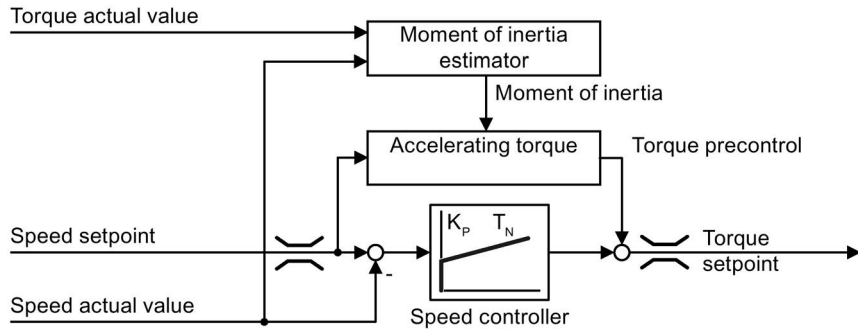

Image 6-38 Influence of the moment of inertia estimator on the speed control

The more precise the value of the moment of inertia in the inverter, the lower the overshoot after speed changes.

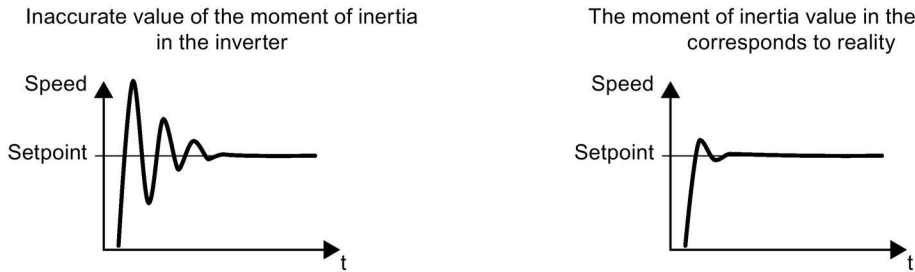

Image 6-39 Influence of the moment of inertia estimator on the speed

#### Function

From the actual speed, the actual motor torque and the frictional torque of the load, the inverter calculates the total moment of inertia of the load and motor.

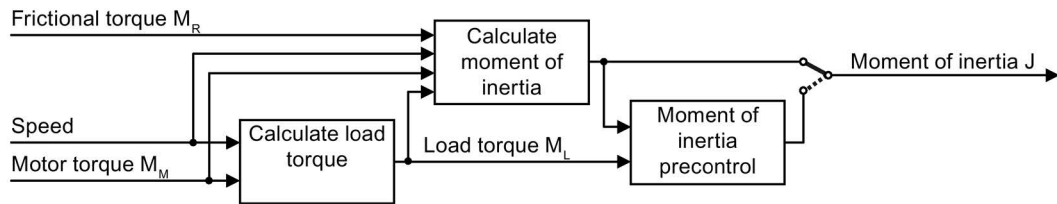
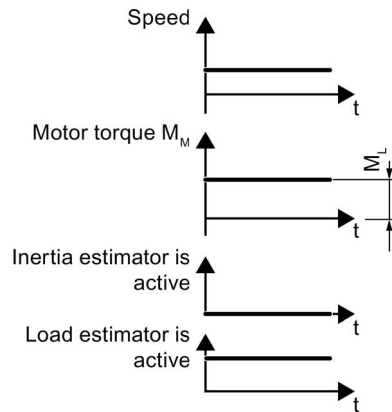

Image 6-40 Overview of the function of the moment of inertia estimator

### Calculating the load torque



At low speeds, the inverter calculates the load torque  $M_L$  from the actual motor torque.

The calculation takes place under the following conditions:

- Speed  $\geq$  p1226
- Acceleration setpoint  $< 8 \text{ 1/s}^2$  ( $\Delta$  speed change 480 rpm per s)
- Acceleration  $\times$  moment of inertia (r1493)  $< 0.9 \times$  p1560

### Calculating the moment of inertia

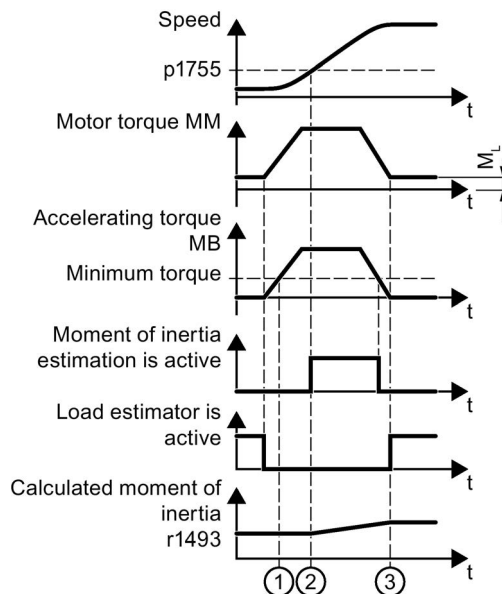

For larger changes, the inverter initially calculates the accelerating torque  $M_B$  as difference between the motor torque  $M_M$ , load torque  $M_L$  and frictional torque  $M_R$ :

$$M_B = M_M - M_L - M_R$$

The moment of inertia  $J$  of the motor and load is then obtained from the accelerating torque  $M_B$  – and the angular acceleration  $\alpha$  ( $\alpha$  = rate of change of speed):

$$J = M_B / \alpha$$

If all of the following conditions are met, the inverter calculates the moment of inertia:

- ① The rated accelerating torque  $M_B$  must satisfy the following two conditions:
  - The sign of  $M_B$  is the same as the direction of the actual acceleration
  - $M_B > p1560 \times$  rated motor torque (r0333)
- ② speed  $> p1755$
- The inverter has calculated the load torque in at least one direction of rotation.
- Acceleration setpoint  $> 8 \text{ 1/s}^2$  ( $\Delta$  speed change 480 rpm per s)
- ③ The inverter calculates the load torque again after acceleration.

**Moment of inertia precontrol**

In applications where the motor predominantly operates with a constant speed, the inverter can only infrequently calculate the moment of inertia using the function described above. Moment of inertia precontrol is available for situations such as these. The moment of inertia precontrol assumes that there is an approximately linear relationship between the moment of inertia and the load torque.

Example: For a horizontal conveyor, in a first approximation, the moment of inertia depends on the load.

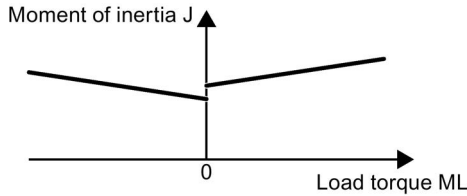

The relationship between load torque and torque is saved in the inverter as linear characteristic.

In a positive direction of rotation:

$$\text{Moment of inertia } J = p5312 \times \text{load torque } M_L + p5313$$

In a negative direction of rotation:

$$\text{Moment of inertia } J = p5314 \times \text{load torque } M_L + p5315$$

You have the following options to determine the characteristic:

- You already know the characteristic from other measurements. In this case, you must set the parameters to known values when commissioning the system.
- The inverter iteratively determines the characteristic by performing measurements while the motor is operational.

**Activating the moment of inertia estimator**

The moment of inertia estimator is deactivated in the factory setting. p1400.18 = 0, p1400.20 = 0, p1400.22 = 0.

If you performed the rotating measurement for the motor identification during quick commissioning, we recommend leaving the moment of inertia estimator deactivated.

**Preconditions**

- You have selected encoderless vector control.
- The load torque must be constant whilst the motor accelerates or brakes.  
Typical of a constant load torque are conveyor applications and centrifuges, for example. Fan applications, for example, are not permitted.
- The speed setpoint is free from superimposed unwanted signals.
- The motor and load are connected to each other with an interference fit.  
Drives with slip between the motor shaft and load are not permitted, e.g. as a result of loose or worn belts.

If the conditions are not met, you must not activate the moment of inertia estimator.

**Procedure**

To activate the moment of inertia estimator, proceed as follows:

1. Set  $p1400.18 = 1$
2. Check:  $p1496 \neq 0$
3. Activate the acceleration model of the speed controller pre-control:  $p1400.20 = 1$ .



You have activated the moment of inertia estimator.

Parameter	Explanation		
r0333	<b>Rated motor torque [Nm]</b>		
p0341	<b>Motor moment of inertia</b> (factory setting: 0 kgm <sup>2</sup> ) The inverter sets the parameter when selecting a listed motor. The parameter is then write-protected.		
p0342	<b>Moment of inertia ratio, total to motor</b> (factory setting: 1) Ratio of moment of inertia load + motor to moment of inertia of motor without load		
p1400	<b>Speed control configuration</b>		
	.18	1 signal: Moment of inertia estimator active	
	.20	1 signal: Acceleration model on	
	.22	1 signal	Moment of inertia estimator retain value when motor switched off
		0 signal	Moment of inertia estimator reset value to initial value $J_0$ when motor switched off: $J_0 = p0341 \times p0342 + p1498$ If the load torque can change when the motor is switched off, set $p1400.22 = 0$ .
.24	1 signal	Accelerated moment of inertia estimator is active.	
r1407	<b>Status word, speed controller</b>		
	.24	1 signal: Moment of inertia estimator is active	
	.25	1 signal: Load estimator is active	
	.26	1 signal: Moment of inertia estimator is engaged	
	.27	1 signal: Accelerated moment of inertia estimator is active.	
r1493	<b>Total moment of inertia, scaled</b> $r1493 = p0341 \times p0342 \times p1496$		
p1496	<b>Acceleration precontrol scaling</b> (factory setting: 0%) According to rotating measurement of the motor data identification is $p1496 = 100\%$ .		
p1498	<b>Load moment of inertia</b> (factory setting: 0 kgm <sup>2</sup> )		
p1502	<b>Freeze moment of inertia estimator</b> (factory setting: 0) If the load torque changes when accelerating the motor, set this signal to 0.		
	0 signal	Moment of inertia estimator is active	
	1 signal	Determined moment of inertia is frozen	
p1775	<b>Motor model changeover speed encoderless operation</b> Defines the switchover between open-loop and closed-loop controlled operation of the encoderless vector control. When selecting the closed-loop speed control, the inverter sets $p1775 = 13.3\% \times$ rated speed.		

## Advanced settings

Parameter	Explanation		
p1226	<b>Standstill detection, speed threshold</b> (Factory setting: 20 rpm) The moment of inertia estimator only measures the load torque for speeds $\geq$ p1226. p1226 also defines from which speed the inverter switches-off the motor for OFF1 and OFF3.		
p1560	<b>Moment of inertia estimator accelerating torque threshold value</b> (factory setting: 10%)		
p1561	<b>Moment of inertia estimator change time inertia</b> (factory setting: 500 ms)	The lower that p1561 or p1562 is, the shorter the moment of inertia estimator measurements.  The larger p1561 or p1562 is, the more accurate the results provided by the moment of inertia estimator.	
p1562	<b>Moment of inertia estimator change time load</b> (factory setting: 10 ms)		
p1563	<b>Moment of inertia estimator load torque positive direction of rotation</b> (factory setting: 0 Nm)		
p1564	<b>Moment of inertia estimator load torque negative direction of rotation</b> (factory setting: 0 Nm)		
p5310	<b>Moment of inertia precontrol configuration</b> (factory setting: 0000 bin)		
	.00	1 signal: Activates calculation of the characteristic (p5312 ... p5315)	
	.01	1 signal: Activates moment of inertia precontrol	
		p5310.00 = 0, p5310.01 = 0	Deactivating moment of inertia precontrol
		p5310.00 = 1, p5310.01 = 0	Adapting the moment of inertia precontrol
		p5310.00 = 0, p5310.01 = 1	Activating the moment of inertia precontrol. The characteristic of the moment of inertia precontrol remains unchanged.
		p5310.00 = 1, p5310.01 = 1	Activating the moment of inertia precontrol. The inverter adapts the characteristic in parallel.
r5311	<b>Moment of inertia precontrol status word</b>		
	.00	1 signal: New measuring points for the characteristic of the moment of inertia precontrol are available	
	.01	1 signal: New parameters are been calculated	
	.02	1 signal: Moment of inertia precontrol active	
	.03	1 signal: The characteristic in the positive direction of rotation has been calculated and is ready	
	.04	1 signal: The characteristic in the negative direction of rotation has been calculated and is ready	
	.05	1 signal: The inverter writes actual results to the parameter	
p5312	<b>Moment of inertia precontrol linear positive</b> (factory setting: 0 1/s <sup>2</sup> )	In a positive direction of rotation: Moment of inertia = p5312 × load torque + p5313	
p5313	<b>Moment of inertia precontrol constant positive</b> (factory setting: 0 kgm <sup>2</sup> )		
p5314	<b>Moment of inertia precontrol linear negative</b> (factory setting: 0 1/s <sup>2</sup> )	In a negative direction of rotation: Moment of inertia = p5314 × load torque + p5315	
p5315	<b>Moment of inertia precontrol constant negative</b> (factory setting: 0 kgm <sup>2</sup> )		

## 6.5.2.6 Pole position identification

### The pole position of a synchronous motor

The pole position of a synchronous motor is the deviation between the magnetic axis in the rotor and the magnetic axis in the stator.

The image below shows you the pole position of a synchronous motor in a simplified cross-section.

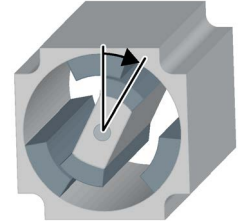

The inverter must know the pole position of the rotor in the motor in order to be able to control the torque and speed of a synchronous motor.

### Pole position identification

The inverter must measure the pole position for motors not equipped with an encoder, or for encoders, which do not supply the information regarding the pole position.

If you are using a Siemens motor, then the inverter automatically selects the appropriate technique to determine the pole position, and when required starts the pole position identification.

#### Motor without an encoder

Each time the motor is switched on (ON/OFF1 command), the inverter measures the pole position.

As a result of the measurement, the motor responds to an ON command with a delay of up to 1 second. The motor shaft can rotate slightly during the measurement.

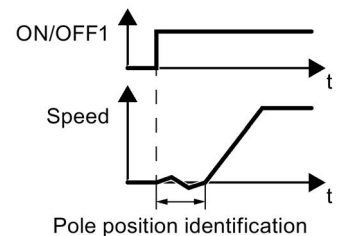

Identifying the pole position using a measurement

### 6.5.3 Torque control

Torque control is part of the vector control and normally receives its setpoint from the speed controller output. By deactivating the speed controller and directly entering the torque setpoint, the closed-loop speed control becomes closed-loop torque control. The inverter then no longer controls the motor speed, but the torque that the motor generates.

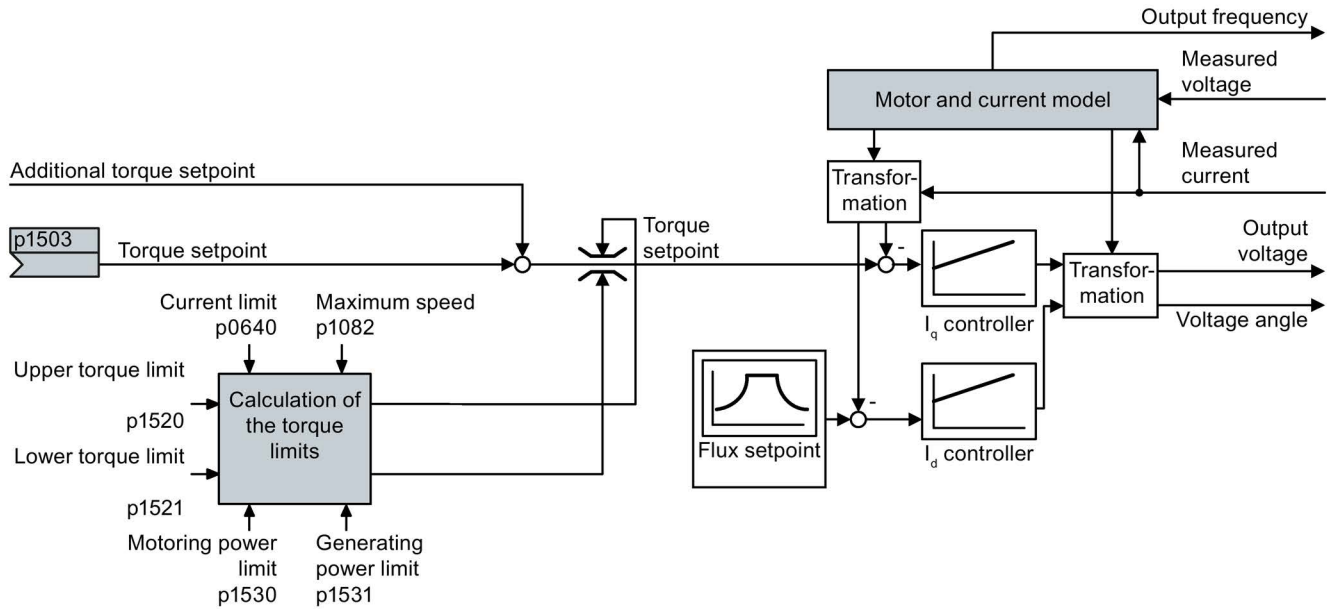

Image 6-41 Simplified function diagram of the closed-loop torque control

#### Typical applications for torque control

The torque control is used in applications where the motor speed is specified by the connected driven load. Examples of such applications include:

- Load distribution between master and slave drives:  
The master drive is speed controlled, the slave drive is torque controlled.
- Winding machines

#### Commissioning the torque control

The torque control only functions error-free if, during the quick commissioning, you correctly set the motor data and performed the motor data identification with the motor in the cold state.



Commissioning (Page 127)



Table 6- 36 The most important torque control parameters

Parameter	Description
p1300	<b>Control mode:</b> 22: Torque control without speed encoder
p0300 ... p0360	<b>Motor data</b> are transferred from the motor rating plate during quick commissioning and calculated with the motor data identification
p1511	<b>Additional torque</b>
p1520	<b>Upper torque limit</b>
p1521	<b>Lower torque limit</b>
p1530	<b>Motoring power limit</b>
p1531	<b>Regenerative power limit</b>

Additional information about this function is provided in the parameter list and in function diagrams 6030 onwards in the List Manual.

## 6.6 Protection functions



The frequency inverter offers protective functions against overtemperature and overcurrent for both the frequency inverter as well as the motor. Further, the frequency inverter protects itself against an excessively high DC link voltage when the motor is regenerating.

### 6.6.1 Inverter temperature monitoring

The inverter temperature is essentially defined by the following effects:

- The ambient temperature
- The ohmic losses increasing with the output current
- Switching losses increasing with the pulse frequency

#### Monitoring types

The inverter monitors its temperature using the following monitoring types:

- I<sup>2</sup>t monitoring (alarm A07805, fault F30005)
- Measuring the chip temperature of the Power Module (alarm A05006, fault F30024)
- Measuring the heat sink temperature of the Power Module (alarm A05000, fault F30004)

#### Inverter response to thermal overload

Parameter	Description
r0036	<p><b>Power unit overload I<sup>2</sup>t [%]</b></p> <p>The I<sup>2</sup>t monitoring calculates the inverter utilization based on a current reference value defined in the factory.</p> <ul style="list-style-type: none"> <li>• Actual current &gt; reference value: r0036 becomes higher.</li> <li>• Actual current &lt; reference value: r0036 becomes lower or remains = 0.</li> </ul>
r0037	<p><b>Power unit temperatures [°C]</b></p>
p0290	<p><b>Power unit overload response</b></p> <p>Factory setting and the ability to be changed depends on the hardware. The dependency is described in the List Manual.</p> <p>A thermal overload is present if the inverter temperature is greater than that specified in p0292.</p> <p>You define how the inverter responds if there is a risk of thermal overload using this parameter. The details are described below.</p>
p0292	<p><b>Power unit temperature warning threshold</b> (factory setting: Heat sink [0] 5 °C, power semiconductor [1] 15 °C)</p> <p>The value is set as a difference to the shutdown temperature.</p>
p0294	<p><b>Power unit warning at I<sup>2</sup>t overload</b> (factory setting: 95 %)</p>

### Overload response for p0290 = 0

The inverter responds depending on the control mode that has been set:

- In vector control, the inverter reduces the output current.
- In U/f control, the inverter reduces the speed.

Once the overload condition has been removed, the inverter re-enables the output current or speed.

If the measure cannot prevent an inverter thermal overload, then the inverter switches off the motor with fault F30024.

### Overload response for p0290 = 1

The inverter immediately switches off the motor with fault F30024.

### Overload response for p0290 = 2

We recommend this setting for drives with square-law torque characteristic, e.g. fans.

The inverter responds in two stages:

1. If you operate the inverter with increased pulse frequency setpoint p1800, then the inverter reduces its pulse frequency starting at p1800.

In spite of the temporarily reduced pulse frequency, the base load output current remains unchanged at the value that is assigned to p1800.

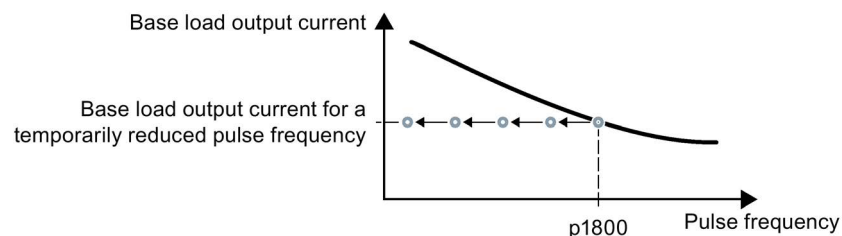

Image 6-42 Derating characteristic and base load output current for overload

Once the overload condition has been removed, the inverter increases the pulse frequency back to the pulse frequency setpoint p1800.

2. If it is not possible to temporarily reduce the pulse frequency, or the risk of thermal overload cannot be prevented, then stage 2 follows:
  - In vector control, the inverter reduces its output current.
  - In U/f control, the inverter reduces the speed.

Once the overload condition has been removed, the inverter re-enables the output current or speed.

If both measures cannot prevent a power unit thermal overload, then the inverter switches off the motor with fault F30024.

### Overload response for p0290 = 3

If you operate the inverter with increased pulse frequency, then the inverter reduces its pulse frequency starting at the pulse frequency setpoint p1800.

In spite of the temporarily reduced pulse frequency, the maximum output current remains unchanged at the value that is assigned to the pulse frequency setpoint. Also see p0290 = 2.

Once the overload condition has been removed, the inverter increases the pulse frequency back to the pulse frequency setpoint p1800.

If it is not possible to temporarily reduce the pulse frequency, or the measure cannot prevent a power unit thermal overload, then the inverter switches off the motor with fault F30024.

### Overload response for p0290 = 12

The inverter responds in two stages:

1. If you operate the inverter with increased pulse frequency setpoint p1800, then the inverter reduces its pulse frequency starting at p1800.

There is no current derating as a result of the higher pulse frequency setpoint.

Once the overload condition has been removed, the inverter increases the pulse frequency back to the pulse frequency setpoint p1800.

2. If it is not possible to temporarily reduce the pulse frequency, or the risk of inverter thermal overload cannot be prevented, then stage 2 follows:

- In vector control, the inverter reduces the output current.
- In U/f control, the inverter reduces the speed.

Once the overload condition has been removed, the inverter re-enables the output current or speed.

If both measures cannot prevent a power unit thermal overload, then the inverter switches off the motor with fault F30024.

### Overload response for p0290 = 13

We recommend this setting for drives with high starting torque, e.g. horizontal conveyors or extruders.

If you operate the inverter with increased pulse frequency, then the inverter reduces its pulse frequency starting at the pulse frequency setpoint p1800.

There is no current derating as a result of the higher pulse frequency setpoint.

Once the overload condition has been removed, the inverter increases the pulse frequency back to the pulse frequency setpoint p1800.

If it is not possible to temporarily reduce the pulse frequency, or the measure cannot prevent a power unit thermal overload, then the inverter switches off the motor with fault F30024.

## 6.6.2 Motor temperature monitoring using a temperature sensor

### Connecting the temperature sensor

It is permissible to use one of the following sensors to protect the motor against overtemperature:

- Temperature switch (e.g. bimetallic switch)
- PTC sensor
- KTY84 sensor
- PT1000 sensor



Connect the temperature sensor of the motor to terminals 14 and 15 of the inverter.

### Temperature switch



The inverter interprets a resistance  $\geq 100 \Omega$  as being an opened temperature switch and responds according to the setting for p0610.

### PTC sensor



The inverter interprets a resistance  $> 1650 \Omega$  as being an overtemperature and responds according to the setting for p0610.

The inverter interprets a resistance  $< 20 \Omega$  as being a short-circuit and responds with alarm A07015. If the alarm is present for longer than 100 milliseconds, the inverter shuts down with fault F07016.

## KTY84 sensor

### NOTICE

#### Motor overheating due to incorrectly connected KTY sensor

If a KTY sensor is connected with incorrect polarity, the motor can become damaged due to overheating, as the inverter cannot detect a motor overtemperature condition.

- Connect the KTY sensor with the correct polarity.

 Using a KTY sensor, the inverter monitors the motor temperature and the sensor itself for wire-break or short-circuit:

- Temperature monitoring:  
The inverter uses a KTY sensor to evaluate the motor temperature in the range from  $-48^{\circ}\text{C}$  ...  $+248^{\circ}\text{C}$ .  
Use the p0604 or p0605 parameter to set the temperature for the alarm and fault threshold.
  - Overtemperature alarm (A07910):
    - motor temperature  $>$  p0604 and p0610 = 0
  - Overtemperature fault (F07011):  
The inverter responds with a fault in the following cases:
    - motor temperature  $>$  p0605
    - motor temperature  $>$  p0604 and p0610  $\neq$  0
- Sensor monitoring (A07015 or F07016):
  - Wire-break:  
The inverter interprets a resistance  $>$  2120  $\Omega$  as a wire-break and outputs the alarm A07015. After 100 milliseconds, the inverter changes to the fault state with F07016.
  - Short-circuit:  
The inverter interprets a resistance  $<$  50  $\Omega$  as a short-circuit and outputs the alarm A07015. After 100 milliseconds, the inverter changes to the fault state with F07016.

## PT1000 sensor



Using a PT1000 sensor, the inverter monitors the motor temperature and the sensor itself for wire-break or short-circuit:

- Temperature monitoring:  
The inverter uses a PT1000 sensor to evaluate the motor temperature in the range from -48° C ... +248° C.  
Use the p0604 or p0605 parameter to set the temperature for the alarm and fault threshold.
  - Overtemperature alarm (A07910):
    - motor temperature > p0604 and p0610 = 0
  - Overtemperature fault (F07011):  
The inverter responds with a fault in the following cases:
    - motor temperature > p0605
    - motor temperature > p0604 and p0610 ≠ 0
- Sensor monitoring (A07015 or F07016):
  - Wire-break:  
The inverter interprets a resistance > 2120 Ω as a wire-break and outputs the alarm A07015. After 100 milliseconds, the inverter changes to the fault state with F07016.
  - Short-circuit:  
The inverter interprets a resistance < 603 Ω as a short-circuit and outputs the alarm A07015. After 100 milliseconds, the inverter changes to the fault state with F07016.

## Setting parameters for the temperature monitoring

Parameter	Description
p0335	<b>Motor-cooling method</b> (factory setting: 0) 0: Natural cooling - with fan on the motor shaft 1: Forced ventilation - with a separately driven fan 2: Liquid cooling 128: No fan
p0601	<b>Motor temperature sensor type</b> 0: No sensor (factory setting) 1: PTC 2: KTY84 4: Temperature switch 6: PT1000
p0604	<b>Mot_temp_mod 2 / sensor alarm threshold</b> (factory setting 130° C) For monitoring the motor temperature with KTY84/PT1000.
p0605	<b>Mot_temp_mod 1/2 / sensor threshold and temperature value</b> (factory setting: 145° C) For monitoring the motor temperature with KTY84/PT1000.
p0610	<b>Motor overtemperature response</b> (factory setting: 12) Determines the inverter behavior when the motor temperature reaches the alarm threshold p0604. 0: Alarm A07910, no fault. 1: Alarm A07910 and fault F07011. The inverter reduces its current limit. 2: Alarm A07910 and fault F07011. 12: Alarm A07910 and fault F07011. For use of the thermal motor model in parallel to the temperature sensor: After switching off the supply voltage, the inverter saves the most-recently calculated difference to the ambient air temperature. After switching the supply voltage on again, the thermal motor model starts with 90% of the previously saved difference temperature.
p0640	<b>Current limit [A]</b>

Additional information on the motor temperature monitoring can be found in function diagram 8016 of the List Manual.



### 6.6.3 Protecting the motor by calculating the motor temperature

The inverter calculates the motor temperature based on a thermal motor model with the following properties:

- The inverter calculates the motor temperature:
  - In thermal motor model 1, the inverter calculates the temperature in the stator winding.
  - In thermal motor models 2 and 3, the inverter calculates the temperatures in the rotor and in the stator winding.
- The thermal motor model detects temperature increases much faster than a temperature sensor.
- After switching off the supply voltage, the inverter saves the most-recently calculated difference to the ambient air temperature (factory setting: p0610 = 12). After switching the supply voltage on again, the thermal motor model starts with 90% of the previously saved difference temperature.

If you use the thermal motor model together with a temperature sensor, e.g. a PT1000, the inverter corrects the model using the measured temperature.

Thermal motor model 2 for induction motors

The thermal motor model 2 for induction motors is a thermal 3-mass model, consisting of stator core, stator winding and rotor.

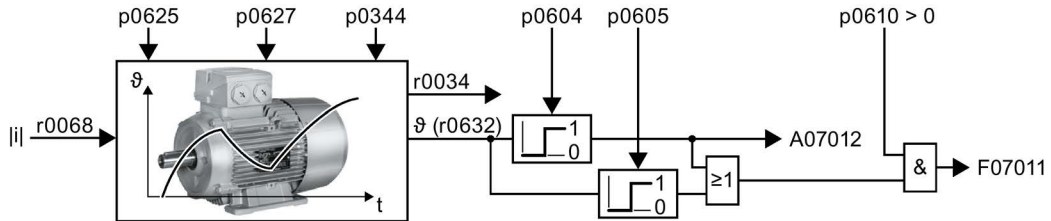

Image 6-43 Thermal motor model 2 for induction motors

Table 6-37 Thermal motor model 2 for induction motors

Parameter	Description
r0068	<b>CO: Absolute actual current value</b>
p0610	<b>Motor overtemperature response</b> (factory setting: 12)
	0: No response, alarm only, no reduction of $I_{max}$
	1: Messages, reduction of $I_{max}$
	2: Messages, no reduction of $I_{max}$
12: Messages, no reduction of $I_{max}$ , temperature is saved	
p0344	<b>Motor weight (for thermal motor type)</b> (factory setting: 0.0 kg)
p0604	<b>Mot_temp_mod 2/KTY alarm threshold</b> (factory setting: 130.0° C) Motor temperature > p0604 ⇒ fault F07011.
p0605	<b>Mot_temp_mod 1/2 threshold</b> (factory setting: 145.0° C) Motor temperature > p0605 ⇒ alarm A07012.
p0612	<b>Mot_temp_mod activation</b>
	.01 1 signal: Activate motor temperature model 2 for induction motors
	.09 1 signal: Activate motor temperature model 2 expansions The inverter sets bit 09 = 1 after commissioning. If you load the parameter settings for firmware version ≤ V4.6 into the inverter, bit 09 = 0 remains.
p0627	<b>Motor overtemperature, stator winding</b> (factory setting: 80 K)
p0625	<b>Motor ambient temperature during commissioning</b> (factory setting: 20° C) Specification of the motor ambient temperature in °C at the instant of the motor data identification.
r0632	<b>Mot_temp_mod stator winding temperature</b> [°C]

Further information is provided in the function charts 8016 and 8017 of the List Manual.

### Thermal motor model 3 for encoderless synchronous motors

The thermal motor model 3 for encoderless synchronous motors 1FK7 or 1FG1 is a thermal 3-mass model, consisting of stator core, stator winding and rotor.

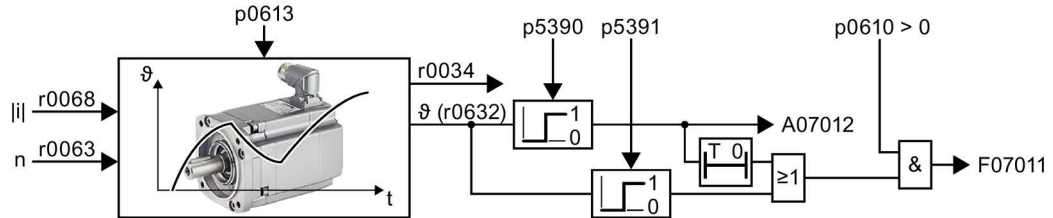

Image 6-44 Thermal motor model 3 for 1FK7 encoderless synchronous motors

Table 6- 38 Thermal motor model 3 for 1FK7 encoderless synchronous motors

Parameter	Description	
r0034	<b>CO: Thermal motor load [%]</b>	
r0063	<b>CO: Actual speed value [rpm]</b>	
r0068	<b>CO: Actual current value [A]</b>	
p0610	<b>Motor overtemperature response</b> (factory setting: 12)	
	0:	No response, alarm only, no reduction of $I_{max}$
	1:	Messages, reduction of $I_{max}$
	2:	Messages, no reduction of $I_{max}$
12:	Messages, no reduction of $I_{max}$ , temperature is saved	
p0612	<b>Mot_temp_mod activation</b>	
	.02	1 signal: Activate motor temperature model 3 for 1FK7 or 1FG1 encoderless synchronous motors
p5390	<b>Mot_temp_mod 1/3 alarm threshold</b> (factory setting: 110.0° C) Motor temperature > p5390 ⇒ alarm A07012.	After selecting an encoderless synchronous motor 1FK7 or 1FG1 (p0300) or a listed induction motor (p0301) during the commissioning, the inverter sets thermal motor model 3 and the parameters to values appropriate for the motor type.  The parameters are write-protected for listed motors (p0301 ≥ 0).
p5391	<b>Mot_temp_mod 1/3 fault threshold</b> (factory setting: 120.0° C) Motor temperature > p5391 or motor temperature > p5390, longer than a motor-dependent time calculated by the inverter ⇒ fault F07011.	
p0613	<b>Mot_temp_mod 1/3 ambient air temperature</b> (factory setting: 20° C) Expected motor ambient temperature in °C for motor operation.	
p0625	<b>Motor ambient temperature during commissioning</b> (factory setting: 20° C) Motor ambient temperature in °C at the instant of the motor data identification.	
r0632	<b>Mot_temp_mod stator winding temperature [°C]</b>	

Further information is provided in the function charts 8016 and 8017 of the List Manual.

### **Thermal motor model 1 for synchronous motors**

Further information about thermal motor model 1 for synchronous motors is provided in the function charts 8016 and 8017 of the List Manual.

## 6.6.4 Overcurrent protection

The vector control ensures that the motor current remains within the set torque limits.

If you use U/f control, you cannot set any torque limits. The U/f control prevents too high a motor current by influencing the output frequency and the motor voltage (I-max controller).

### I\_max controller

#### Requirements

The torque of the motor must decrease at lower speeds, which is the case, for example, with fans.

The load must not drive the motor continuously, e.g. when lowering hoisting gear.

#### Function

The I-max controller influences the output frequency and the motor voltage.

If the motor current reaches the current limit during acceleration, the I-max controller extends the acceleration operation.

If the load of the motor is so large during stationary operation that the motor current reaches the current limit, the I-max controller reduces the speed and the motor voltage until the motor current is in the permissible range again.

If the motor current reaches the current limit during deceleration, the I-max controller extends the deceleration operation.

### Settings

You only have to change the factory settings of the I-max controller if the drive tends to oscillate when it reaches the current limit or if it is shut down due to overcurrent.

Table 6- 39 I-max controller parameters

Parameter	Description
p0305	<b>Rated motor current</b>
p0640	<b>Motor current limit</b>
p1340	<b>Proportional gain of the I-max controller for speed reduction</b>
p1341	<b>Integral time of the I-max controller for speed reduction</b>
r0056.13	<b>Status: I-max controller active</b>
r1343	<b>Speed output of the I-max controller</b> Shows the amount to which the I-max controller reduces the speed.

For more information about this function, see function diagram 6300 in the List Manual.

## 6.6.5 Limiting the maximum DC link voltage

### How does the motor generate overvoltage?

An induction motor operates as a generator if it is driven by the connected load. A generator converts mechanical energy into electrical energy. The electrical energy flows back into the inverter. If the inverter cannot dissipate the electrical energy, for example in a braking resistor, then the DC-link voltage  $V_{dc}$  increases in the inverter.

Above a critical DC-link voltage both the inverter and the motor will be damaged. Before the voltage can reach critical levels, however, the inverter switches the motor off with the fault message "DC-link overvoltage".

### Protecting the motor and inverter against overvoltage

The  $V_{dc\_max}$  control avoids an excessively high DC-link voltage, assuming that the application permits this. The  $V_{dc\_max}$  control increases the ramp-down time of the motor when braking, so that the motor feeds back only as little energy to the inverter as is covered by the losses in the inverter.

The  $V_{dc\_max}$  control is not suitable for applications where the motor is continuously in the generator mode. This includes, for example, cranes or applications involving braking large moments of inertia.



Electrically braking the motor (Page 283)

The  $V_{dc\_max}$  control is only possible with the PM230, PM240, PM240-2 and PM340 Power Modules. The  $V_{dc\_max}$  control is not required if you use a braking resistor.

PM250 Power Modules feed back regenerative energy into the line supply. Therefore, the  $V_{dc\_max}$  control is not required for a PM250 Power Module.

## Parameters of the Vdc\_max control

The parameters differ depending on the motor control mode.

Parameter for V/f control	Parameter for vector control	Description
p1280 = 1	p1240 = 1	<b>Vdc controller configuration</b> (Factory setting: 1) 1: Vdc controller is enabled
r1282	r1242	<b>Vdc_max control activation level</b> DC link voltage value above which the Vdc_max control is activated
p1283	p1243	<b>Vdc_max control dynamic factor</b> (factory setting: 100 %) Scaling control parameters p1290, p1291 and p1292
p1284	---	<b>Vdc_max controller time threshold</b> Setting the monitoring time of the Vdc_max controller.
p1290	p1250	<b>Vdc_max control proportional gain</b> (factory setting: 1)
p1291	p1251	<b>Vdc_max control integral time</b> (factory setting p1291: 40 ms, p1251: 0 ms)
p1292	p1252	<b>Vdc_max control rate time</b> (factory setting p1292: 10 ms, p1252: 0 ms)
p1294	p1254	<b>Vdc_max control automatic ON level sensing</b> (Factory setting, dependent on the Power Module) Automatically sense switch-on levels of the Vdc_max control. 0: Automatic detection disabled 1: Automatic detection enabled
p0210	p0210	<b>Unit supply voltage</b> If p1254 or p1294 = 0, the inverter uses this parameter to calculate the switch-in thresholds of the Vdc_max control. Set this parameter to the actual value of the input voltage.

For more information about this function, see the List Manual (function diagrams 6320 and 6220).

## 6.7 Application-specific functions



The inverter offers a series of functions that you can use depending on your particular application, e.g.:

- Switching over units
- Braking functions
- Automatic restart and flying restart
- Basic process control functions
- Logical and arithmetic functions using function blocks that can be freely interconnected
- Calculating the energy saving for fluid flow machines

Refer to the following sections for detailed descriptions.



### 6.7.1 Unit changeover

#### Description

Using the unit switchover function, you can switch over parameters and process variables for input and output to an appropriate system of units: US units, SI units or relative variables as a %.

Independent of this, you can define the units for process variables or change over to percentage values.

The following options are available:

-  Changing over the motor standard (Page 278) IEC/NEMA
-  Changing over the unit system (Page 279)
-  Changing over process variables for the technology controller (Page 279)

The motor standard, the unit system as well as the process variables can only be changed with STARTER or Startdrive offline.



### Restrictions for the unit changeover function

- The values on the rating plate of the inverter or motor cannot be displayed as percentage values.
- Using the unit changeover function several times (for example, percent → physical unit 1 → physical unit 2 → percent) may lead to the original value being changed by one decimal place as a result of rounding errors.
- If the unit is changed over into percent and the reference value is then changed, the percentage values relate to the new reference value.

Example:

- For a reference speed of 1500 rpm, a fixed speed of 80% corresponds to a speed of 1200 rpm.
- If the reference speed is changed to 3000 rpm, then the value of 80% is kept and now means 2400 rpm.

### Reference variables for unit changeover

p2000	Reference frequency/speed
p2001	Reference voltage
p2002	Reference current
p2003	Reference torque
r2004	Reference power
p2005	Reference angle
p2006	Reference temperature

### 6.7.1.1 Changing over the motor standard

You change over the motor standard using p0100. The following applies:

- p0100 = 0: IEC motor (50 Hz, SI units)
- p0100 = 1: NEMA motor (60 Hz, US units)
- p0100 = 2: NEMA motor (60 Hz, SI units)

The parameters listed below are affected by the changeover.

Table 6- 40 Variables affected by changing over the motor standard

P no.	Designation	Unit for p0100 =		
		0*)	1	2
r0206	Power Module rated power	kW	HP	kW
p0307	Rated motor power	kW	HP	kW
p0316	Motor torque constant	Nm/A	lbf ft/A	Nm/A
r0333	Rated motor torque	Nm	lbf ft	Nm
p0341	Motor moment of inertia	kgm <sup>2</sup>	lb ft <sup>2</sup>	kgm <sup>2</sup>
p0344	Motor weight (for thermal motor type)	kg	Lb	kg
r1969	Speed_cont_opt moment of inertia determined	kgm <sup>2</sup>	lb ft <sup>2</sup>	kgm <sup>2</sup>

\*) Factory setting

### 6.7.1.2 Changing over the unit system

You change over the unit system using p0505. The following selection options are available:

- p0505 = 1: SI units (factory setting)
- p0505 = 2: SI units or % relative to SI units
- p0505 = 3: US units
- p0505 = 4: US units or % relative to US units

---

#### **Note**

##### **Special features**

The percentage values for p0505 = 2 and for p0505 = 4 are identical. For internal calculation and for the output of physical variables, it is, however, important whether the conversion is made to SI or US units.

In the case of variables for which changeover to % is not possible, the following applies:  
p0505 = 1  $\triangleq$  p0505 = 2 and p0505 = 3  $\triangleq$  p0505 = 4.

In the case of variables whose units are identical in the SI system and US system, and which can be displayed as a percentage, the following applies:  
p0505 = 1  $\triangleq$  p0505 = 3 and p0505 = 2  $\triangleq$  p0505 = 4.

##### **Parameters affected by changeover**

The parameters affected by changing over the unit system are grouped according to unit. An overview of the unit groups and the possible units can be found in the List Manual in the Section "Unit group and unit selection".

---

### 6.7.1.3 Changing over process variables for the technology controller

---

#### **Note**

We recommend that the units and reference values of the technology controller are coordinated and harmonized with one another during commissioning.

Subsequent modification in the reference variable or the unit can result in incorrect calculations or displays.

---

### Changing over process variables of the technology controller

You change over the process variables of the technology controller using p0595. For physical values, you define the reference variable in p0596.

The parameters affected by changing over units of the technology controller belong to unit group 9\_1. For details, please refer to the section titled "Unit group and unit choice" in the List Manual.

### 6.7.1.4 Switching units with STARTER

**Precondition**

The inverter must be in the offline mode in order to change over the units.

STARTER shows whether you change settings online in the inverter or change offline in the PC (**Online mode** / **Offline mode**).

You switch over the mode using the adjacent buttons in the menu bar.

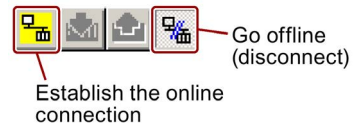

**Procedure**



To change over the units with STARTER, proceed as follows:

1. Select the configuration
2. Go to the "Units" tab in the configuration screen form to change over the units
3. Changing over the system of units
4. Select process variables of the technological controller
5. Adapting to the line supply

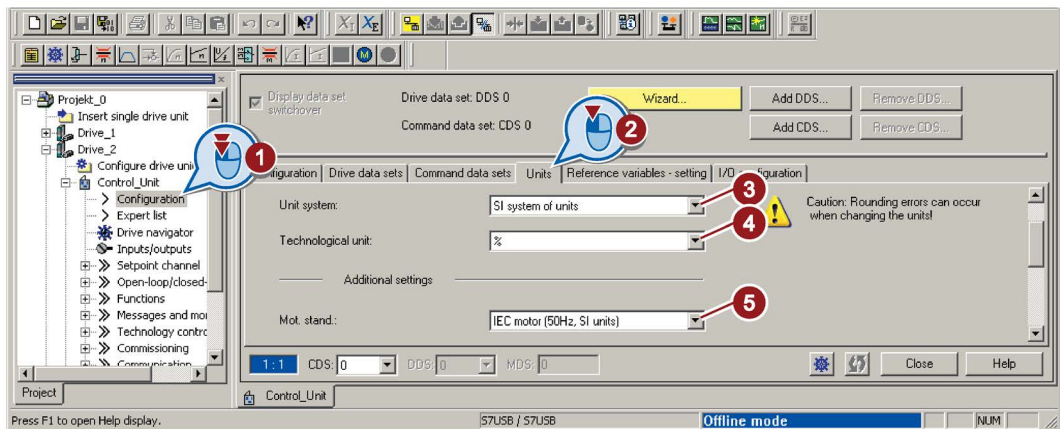

6. Save your settings.
7. Go online.
 

The inverter signals that offline, other units and process variables are set than in the inverter itself.
8. Accept these settings in the inverter.

	Online	Offline
<b>CU type</b>		
Unit system	inconsistent	inconsistent

If these differences are not adjusted, the online representation may be incomplete.

Adjust via:

<= Download      Overwriting of the data in the target device

Load to PG ==>      Overwriting of the data in the project

- You have changed over the units.

## 6.7.2 Calculating the energy saving for fluid flow machines

### Background

Fluid flow machines, which mechanically control the flow rate using valves or throttle flaps, operate with a constant speed corresponding to the line frequency. The lower the flow rate, the poorer the system efficiency. The machine has the poorest efficiency when the valve or throttle flaps are completely closed. Further, undesirable effects can occur, for example the formation of vapor bubbles in liquids (cavitation) or the temperature of the medium being pumped can increase.

The converter controls the flow rate by appropriately varying the speed of the fluid flow machine. As a consequence, the fluid flow machine has the optimum efficiency for each flow rate, and draws less electric power in the partial load range than for closed-loop control concepts based on valves and throttle flaps.

### Function

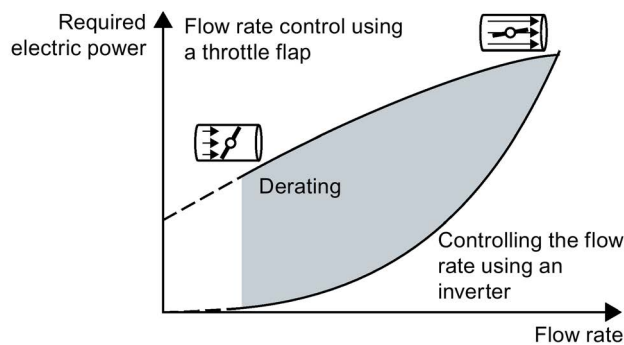

The converter calculates the energy saving from the flow characteristic associated with a mechanical flow control and the measured electric power that is drawn.

The calculation is suitable for centrifugal pumps, fans, radial and axial compressors, for instance.

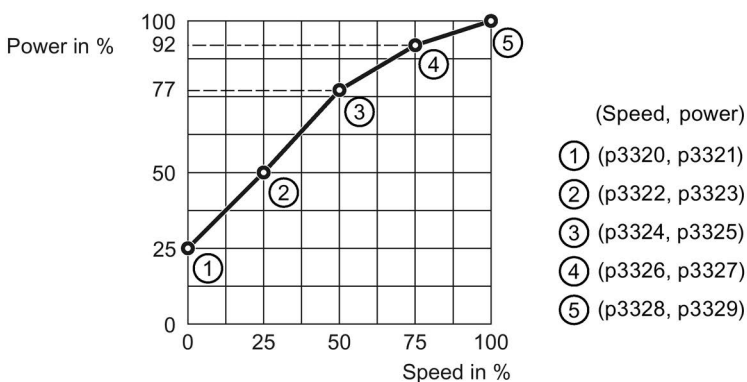
Parameter	Description						
p3320 ... p3329	<p><b>Flow characteristic</b></p>  <p>(Speed, power)</p> <p>① (p3320, p3321)                  ② (p3322, p3323)                  ③ (p3324, p3325)                  ④ (p3326, p3327)                  ⑤ (p3328, p3329)</p> <p>Factory setting of the flow characteristic</p> <p>To set the characteristic, you require the following data from the machine manufacturer for each speed interpolation point:</p> <ul style="list-style-type: none"> <li>• The flow rate of the fluid-flow machine associated with the 5 selected converter speeds</li> <li>• The power drawn at constant speed associated with the five flow rates corresponds to the line frequency and mechanical throttling of the flow rate.</li> </ul>						
r0039	<p><b>Energy display [kWh]</b></p> <table border="1"> <tr> <td>[0]</td> <td><b>Energy balance</b> Energy usage since the last reset</td> </tr> <tr> <td>[1]</td> <td>Energy drawn since the last reset</td> </tr> <tr> <td>[2]</td> <td>Energy fed back since the last reset</td> </tr> </table>	[0]	<b>Energy balance</b> Energy usage since the last reset	[1]	Energy drawn since the last reset	[2]	Energy fed back since the last reset
[0]	<b>Energy balance</b> Energy usage since the last reset						
[1]	Energy drawn since the last reset						
[2]	Energy fed back since the last reset						
p0040	<p><b>Reset energy consumption display</b></p> <p>A signal change 0 → 1 sets r0039[0...2] = 0, r0041 = 0 and r0042 = 0.</p>						
r0041	<p><b>Energy consumption saved (kWh)</b></p> <p>Energy saved referred to 100 operating hours.</p> <p>For less than 100 operating hours, the inverter interpolates the energy saving to 100 operating hours.</p>						
r0042	<p><b>CO: Process energy display [1 ± 1 Wh]</b></p> <p>For display as process variable. Enable with p0043.</p> <table border="1"> <tr> <td>[0]</td> <td><b>Energy balance</b> Energy consumption since the last reset.</td> </tr> <tr> <td>[1]</td> <td>Energy drawn since the last reset</td> </tr> <tr> <td>[2]</td> <td>Energy fed back since the last reset.</td> </tr> </table>	[0]	<b>Energy balance</b> Energy consumption since the last reset.	[1]	Energy drawn since the last reset	[2]	Energy fed back since the last reset.
[0]	<b>Energy balance</b> Energy consumption since the last reset.						
[1]	Energy drawn since the last reset						
[2]	Energy fed back since the last reset.						
p0043	<p><b>BI: Enable energy usage display</b></p> <p>1 signal: Process energy display is active in r0042.</p>						

## 6.7.3 Electrically braking the motor

### Braking with the motor in generating mode

If the motor brakes the connected load electrically, it will convert the kinetic energy of the motor to electrical energy. The electrical energy  $E$  released on braking the load is proportional to the moment of inertia  $J$  of the motor and load and to the square of the speed  $n$ . The motor attempts to pass the energy on to the inverter.

### Main features of the braking functions

#### DC braking

DC braking prevents the motor from transferring braking energy to the inverter. The inverter impresses a DC current into the motor, therefore braking the motor. The motor converts braking energy  $E$  of the load into heat.

- *Advantage:* The motor brakes the load without the inverter having to process regenerative power.
- *Disadvantages:* significant increase in the motor temperature; no defined braking characteristics; no constant braking torque; no braking torque at standstill; braking energy is lost as heat; does not function when the power fails

#### Compound braking

One version of DC braking. The inverter brakes the motor with a defined ramp-down time and superimposes a DC current on the output current.

#### Dynamic braking

Using a braking resistor, the inverter converts the electrical energy into heat.

- *Advantages:* defined braking response; motor temperature does not increase any further; constant braking torque
- *Disadvantages:* Braking resistor required; braking energy  $E$  is lost in the form of heat

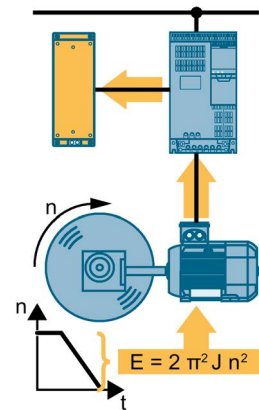
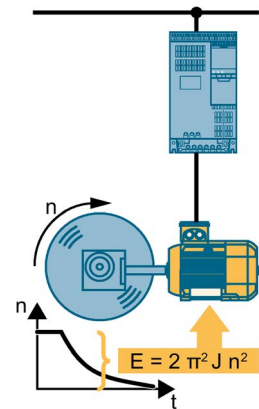

**Braking with regenerative feedback into the line supply**

The inverter feeds electrical energy back into the line supply (energy recovery).

- *Advantages:* Constant braking torque; the braking energy is not completely converted into heat, but regenerated into the line supply; is suitable for all applications; continuous regenerative operation is possible - e.g. when lowering a suspended load
- *Disadvantage:* Does not function for a power failure

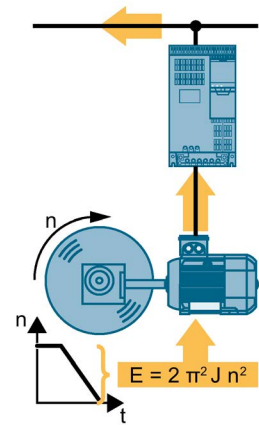

**Which Power Module permits which braking technique?**

Electrical braking methods	Power Modules that can be used
DC braking, compound braking	PM240, PM340
Dynamic braking	PM240, PM340
Braking with regenerative feedback into the line supply	PM250, PM260



### 6.7.3.1 DC braking

DC braking is used for applications without regenerative feedback into the line supply, where the motor can be more quickly braked by impressing a DC current than along a braking ramp.

Typical applications for DC braking include:

- Centrifuges
- Saws
- Grinding machines
- Conveyor belts

#### Function

<p><b>NOTICE</b></p> <p><b>Motor damage caused by overheating</b></p> <p>The motor can overheat if it is braked for long periods of time or frequently using DC braking. This may damage the motor.</p> <ul style="list-style-type: none"> <li>• Monitor the motor temperature.</li> <li>• If the motor gets too hot during operation you must select another braking method or give the motor more time to cool down.</li> </ul>
---

With DC braking, the inverter outputs an internal OFF2 command for the time that it takes to de-energize the motor p0347 - and then impresses the braking current for the duration of the DC braking.

The DC-braking function is possible only for induction motors.

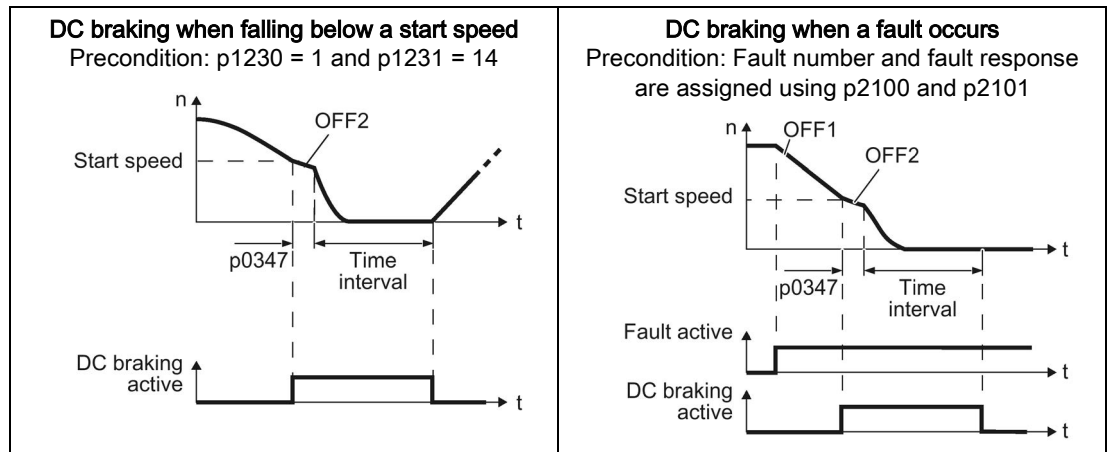

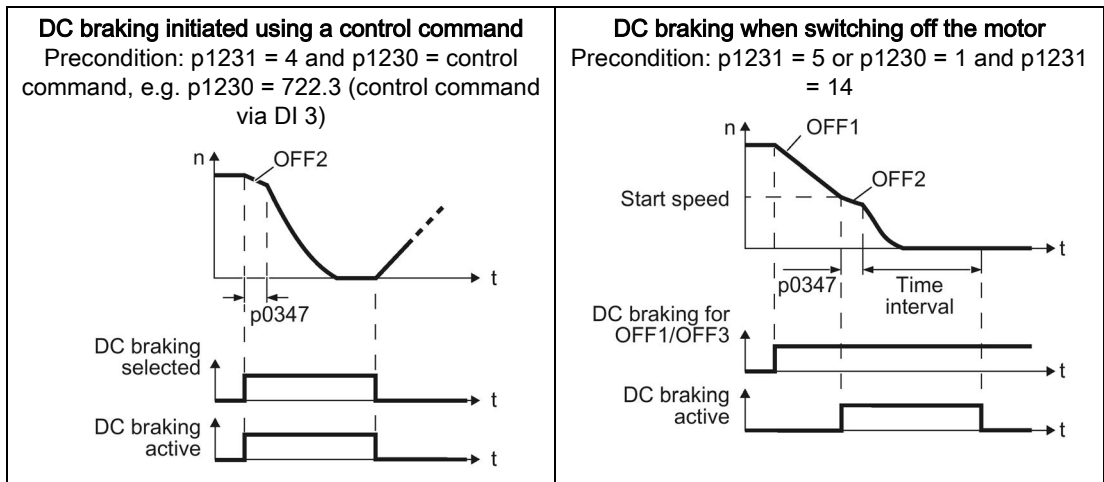

**DC braking when falling below a starting speed**

1. The motor speed has exceeded the starting speed.
2. The inverter activates the DC braking as soon as the motor speed falls below the starting speed.

**DC braking when a fault occurs**

1. A fault occurs, which initiates DC braking as response.
2. The motor brakes along the down ramp to the speed for the start of DC braking.
3. DC braking starts.

**DC braking initiated by a control command**

1. The higher-level control issues the command for DC braking, e.g. using DI3: p1230 = 722.3.
2. DC braking starts.

If the higher-level control withdraws the command during DC braking, the inverter interrupts DC braking and the motor accelerates to its setpoint.

**DC braking when the motor is switched off**

1. The higher-level control switches off the motor (OFF1 or OFF3).
2. The motor brakes along the down ramp to the speed for the start of DC braking.
3. DC braking starts.

## Settings for DC braking

Parameter	Description
p0347	<b>Motor de-excitation time</b> (calculated after quick commissioning) The inverter can trip due to an overcurrent during DC braking if the de-excitation time is too short.
p1230	<b>DC braking activation</b> (factory setting: 0) Signal source to activate DC braking <ul style="list-style-type: none"> <li>• 0 signal: Deactivated</li> <li>• 1 signal: Active</li> </ul>
p1231	<b>Configuring DC braking</b> (factory setting: 0)
	0 No DC braking
	4 General release for DC braking
	5 DC braking for OFF1/OFF3
14 DC braking below the starting speed	
p1232	<b>DC braking braking current</b> (factory setting 0 A)
p1233	<b>DC braking duration</b> (factory setting 1 s)
p1234	<b>DC braking start speed</b> (factory setting 210000 rpm)
r1239	<b>DC braking status word</b>
	.08 DC braking active
	.10 DC braking ready
	.11 DC braking selected
	.12 DC braking selection internally locked
.13 DC braking for OFF1/OFF3	

Table 6- 41 Configuring DC braking as a response to faults

Parameter	Description
p2100	<b>Set fault number for fault response</b> (factory setting 0) Enter the fault number for which DC braking should be activated, e.g. p2100[3] = 7860 (external fault 1).
p2101 = 6	<b>Fault response setting</b> (factory setting 0) Assigning the fault response: p2101[3] = 6.
<p>The fault is assigned an index of p2100. Assign the same index of p2100 or p2101 to the fault and fault response.</p> <p>The inverter's List Manual lists in the "Faults and alarms" list the possible fault responses for every fault. The "DCBRAKE" entry means that it is permissible to set DC braking as response for this particular fault.</p>	

### 6.7.3.2 Compound braking

Typical applications for compound braking include:

- Centrifuges
- Saws
- Grinding machines
- Horizontal conveyors

For these applications, the motor is normally operated with a constant speed, and is only braked down to standstill after longer periods of time.

#### Principle of operation

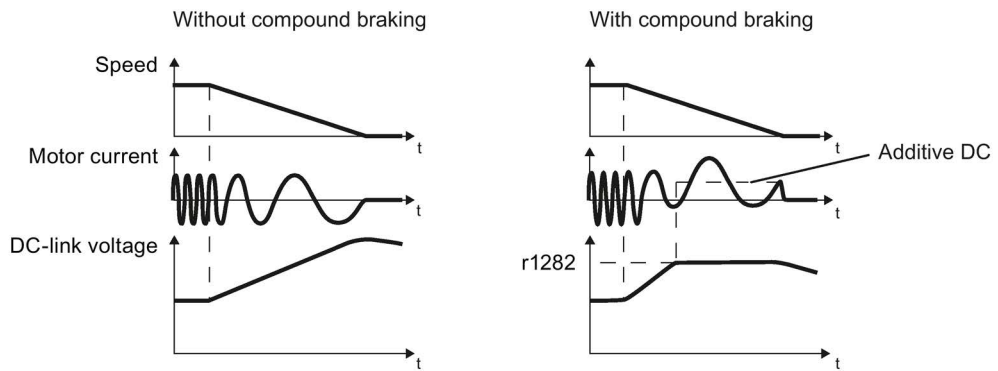

Image 6-45 Motor brakes with and without active compound braking

Compound braking prevents the DC-link voltage increasing above a critical value. The inverter activates compound braking depending on the DC-link voltage. Above a DC-link voltage threshold (r1282), the inverter adds a DC current to the motor current. The DC current brakes the motor and prevents an excessive increase in the DC-link voltage.

---

#### Note

Compound braking is possible only with the U/f control.

Compound braking does not operate in the following cases:

- The "flying restart" function is active
  - DC braking is active
  - Vector control is selected
-

## Setting and enabling compound braking

Parameter	Description
p3856	<b>Compound braking current (%)</b> With the compound braking current, the magnitude of the DC current is defined, which is additionally generated when stopping the motor for operation with U/f control to increase the braking effect. p3856 = 0 Compound braking locked p3856 = 1 ... 250 Current level of the DC braking current as a % of the rated motor current (p0305) Recommendation: $p3856 < 100\% \times (r0209 - r0331) / p0305 / 2$
r3859.0	<b>Compound-braking status word</b> r3859.0 = 1: Compound braking is active

### NOTICE

#### Motor damage from overheating with compound braking

The motor will overheat if braking lasts too long or the motor is braked too often. This may damage the motor.

Monitor the motor temperature. If the motor gets too hot during operation you must select another braking method or give the motor more time to cool down.

### 6.7.3.3 Dynamic braking

Typical applications for dynamic braking include:

- Horizontal conveyors
- Vertical and inclined conveyors
- Hoisting gear

For these applications, dynamic motor behavior with different speeds or continuous change of direction is required.

#### Principle of operation



<b>! CAUTION</b>
<b>Burns when touching a hot braking resistor</b>
A braking resistor reaches high temperatures during operation. Touching the braking resistor may result in burns.
<ul style="list-style-type: none"><li>• Do not touch a braking resistor during operation.</li></ul>

The inverter controls the braking chopper depending on its DC-link voltage. The DC-link voltage increases as soon as the inverter absorbs the regenerative power when braking the motor. The braking chopper converts this power into heat in the braking resistor. This prevents the DC-link voltage from increasing above the limit value  $U_{DC\ link, max}$ .

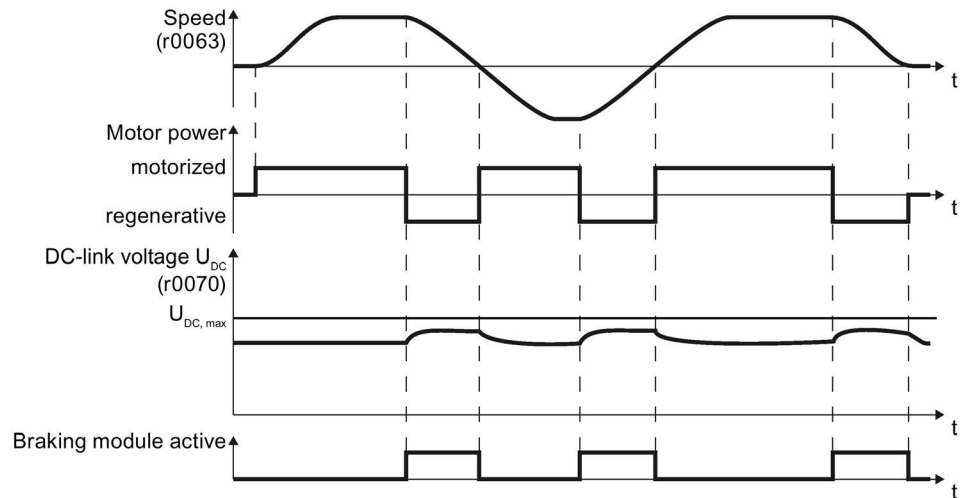

Image 6-46 Simplified representation of dynamic braking with respect to time

## Set dynamic braking

Parameter	Description			
p0219	<p><b>Braking power of the braking resistor</b> (factory setting: 0 kW) Set the braking power of the braking resistor.</p> <p><b>Example:</b> In your particular application, the motor brakes every 10 seconds. In so doing, the braking resistor must handle a braking power of 1 kW for 2 s. Use a braking resistor with a continuous rating of <math>1 \text{ kW} \times 2 \text{ s} / 10 \text{ s} = 0.2 \text{ kW}</math>, and set the maximum braking power to: <math>p0219 = 1 \text{ (kW)}</math>.</p> <p>Under certain circumstances, for low braking power ratings, the inverter extends the ramp-down time of the motor.</p> <p>For <math>p0219 &gt; 0</math>, the inverter deactivates the VDC_max controller.</p>			
p0844	<p><b>No coast down/coast down (OFF2) signal source 1</b></p> <table border="1" style="width: 100%; border-collapse: collapse;"> <tr> <td style="width: 30%; padding: 2px;">p0844 = 722.x</td> <td style="padding: 2px;">Monitor the overtemperature of the braking resistor with digital input x of the inverter.</td> </tr> </table>		p0844 = 722.x	Monitor the overtemperature of the braking resistor with digital input x of the inverter.
p0844 = 722.x	Monitor the overtemperature of the braking resistor with digital input x of the inverter.			

### 6.7.3.4 Braking with regenerative feedback to the line

The typical applications for braking with energy recovery (regenerative feedback into the line supply) are as follows:

- Hoist drives
- Centrifuges
- Unwinders

For these applications, the motor must brake for longer periods of time.

The inverter can feed back up to 100% of its rated power into the line supply (referred to "High Overload" base load).

 Technical data, PM250 (Page 469)

### Setting the braking with regenerative feedback to the line

Parameter	Description
<b>Limiting the regenerative feedback for V/f control (p1300 &lt; 20)</b>	
p0640	<b>Motor series overload factor</b> (factory setting: 0.00 A, default for quick commissioning) It is only possible to limit the regenerative power with V/f control by limiting the motor current. If the current exceeds this value for longer than 10 s, the inverter shuts down the motor with fault F07806.
<b>Limiting feedback with vector control (p1300 ≥ 20)</b>	
p1531	<b>Power limit generative</b> (factory setting: -0.01 kW) The inverter calculates the parameter based on the quick commissioning or with p0340 = 5.



## 6.7.4 Motor holding brake

The motor holding brake holds the motor in position when it is switched off. If the setting is correct, the motor will produce an electrical holding torque before the inverter opens the brake. The inverter does not close the motor holding brake until the motor is at a standstill.

### Function

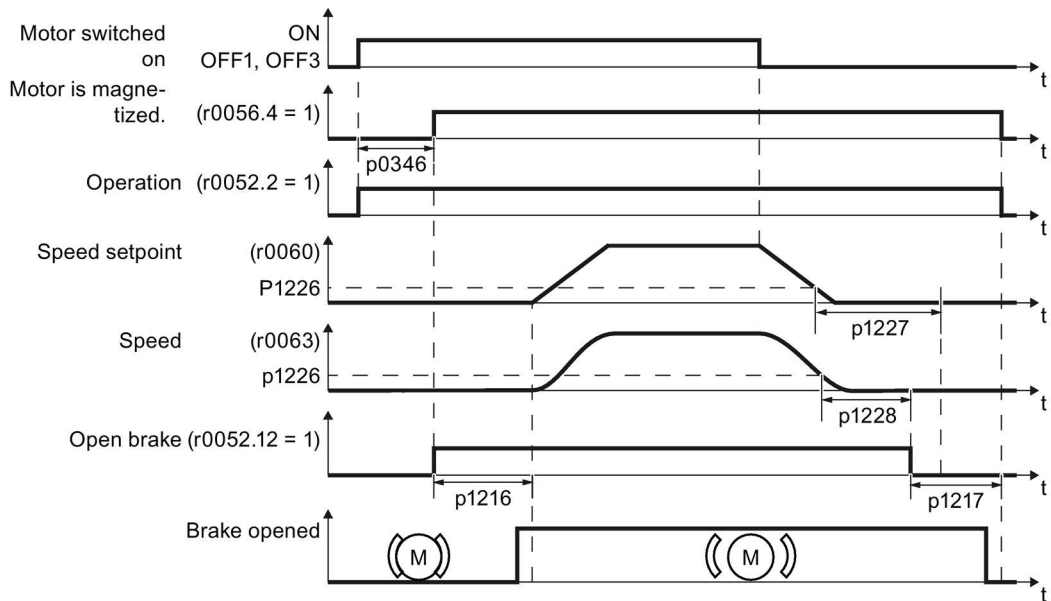

Image 6-47 Motor holding brake function

#### Function after an ON command:

1. With the ON command, the inverter switches the motor on.
2. At the end of the "motor excitation build-up time" ( $p0346$ ), the inverter issues the command to open the brake.
3. The inverter keeps the motor at a standstill until the "motor holding brake opening time"  $p1216$  has ended.

The motor holding brake must be opened within time  $p1216$ .

4. The inverter accelerates the motor to the speed setpoint.

**Function after an OFF1 or OFF3 command:**

1. The inverter brakes the motor down to a standstill and switches it off using the OFF1 or OFF3 command.
2. When braking, the inverter compares the speed setpoint and the actual speed with the "standstill detection speed threshold" p1226:
  - Speed setpoint < p1226: The "standstill detection monitoring time" p1227 starts
  - Current speed < p1226: The "pulse cancellation deceleration time" p1228 starts
3. When the first of the two times (p1227 or p1228) has elapsed, the inverter issues the command to close the brake.
4. After the "motor holding brake closing time" p1217, the inverter switches off the motor. The motor holding brake must close within the time p1217.

**Function after an OFF2 command**

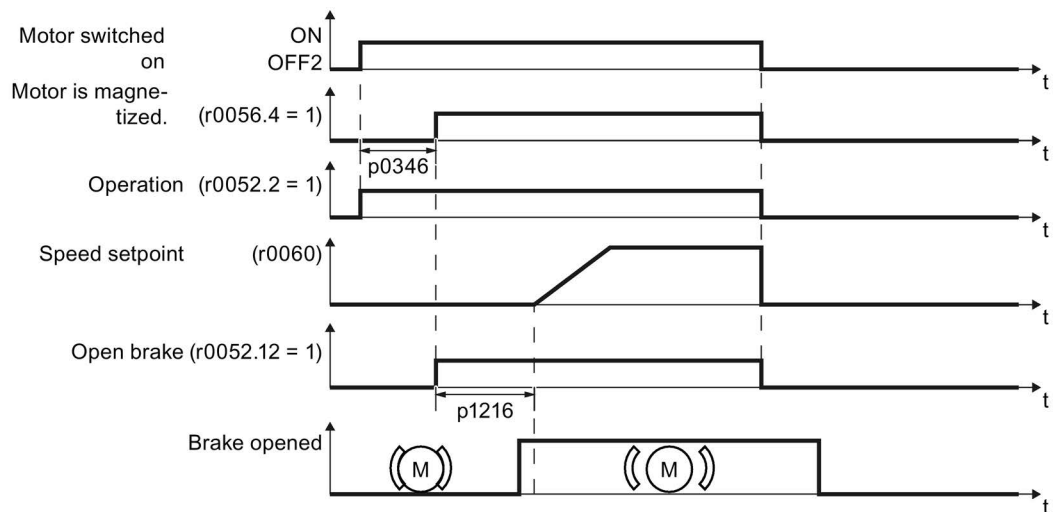

Image 6-48 Controlling the motor holding brake after OFF2

After an OFF2 command, the inverter issues the signal to immediately close the motor holding brake, irrespective of the motor speed.

## Commissioning a motor holding brake



### DANGER

#### Danger to life due to falling loads

For applications such as lifting equipment, cranes or elevators, there is a danger to life if the "Motor holding brake" function is incorrectly set.

- When commissioning the "Motor holding brake" function, secure any dangerous loads, e.g. by applying the following measures:
  - Lower the load down to the floor
  - Cordon off the hazardous area so that nobody can enter it

#### Precondition

The motor holding brake is connected to the inverter.

#### Procedure

To commission the "motor holding brake" function, proceed as follows:



1. Set p1215 = 1.  
The "Motor holding brake" function" is enabled.
2. Check the magnetizing time p0346; the magnetizing time is pre-assigned during commissioning and must be greater than zero.
3. Find out the mechanical opening and closing times from the technical data of the motor holding brake.
  - Depending on the brake size, brake opening times lie between 25 ms and 500 ms.
  - Depending on the brake size, brake closing times lie between 15 ms and 300 ms.
4. Set the following parameters in the inverter suitably for the mechanical opening and closing times of the motor holding brake:
  - p1216 > mechanical opening time of the motor holding brake
  - p1217 > mechanical closing time of the motor holding brake
5. Switch on the motor.
6. Check the acceleration behavior of the drive immediately after the motor has been switched on:
  - If the motor holding brake opens too late, the inverter will accelerate the motor suddenly against the closed motor holding brake.  
Set p1216 larger.
  - If the motor waits too long before accelerating after the motor holding brake has opened, reduce p1216.

7. If the load sags after switching on the motor, then you must increase the motor torque when opening the motor holding brake. Depending on the control mode, you must set different parameters:
  - V/f control (p1300 = 0 to 3):  
Increase p1310 in small steps.  
Increase p1351 in small steps.
  - Vector control (p1300 ≥ 20):  
Increase p1475 in small steps.
8. Switch off the motor.
9. Check the behavior of the drive immediately after the motor has been switched off:
  - If the motor holding brake closes too late, the load briefly sags before the motor holding brake closes.  
Set a larger value for p1217.
  - If the motor waits too long before switching off after the motor holding brake has closed, reduce p1217.

■ You have commissioned the "Motor holding brake" function.

Table 6- 42 Setting the control logic of the motor holding brake

Parameter	Description
p1215 = 1	<b>Enable motor holding brake</b> 0 Motor holding brake locked (factory setting) 1 Motor holding brake just like the sequence control 2: Motor holding brake permanently open 3: Motor holding brake just like the sequential control, connected via BICO
p1216	<b>Motor holding brake opening time</b> (factory setting 0.1 s) p1216 > braking signal relay runtimes + brake release time
p1217	<b>Motor holding brake closing time</b> (factory setting 0.1 s) p1217 > braking signal relay runtimes + brake closing time
r0052.12	<b>"Open motor holding brake" command</b>

Table 6- 43 Advanced settings

Parameter	Description
p0346	<b>Magnetizing time</b> (factory setting 0 s) During this time the induction motor is magnetized. The inverter calculates this parameter using p0340 = 1 or 3.
p0855	<b>Open motor holding brake (imperative)</b> (factory setting 0)
p0858	<b>Close motor holding brake (imperative)</b> (factory setting 0)
p1226	<b>Stationary state detection speed threshold</b> (factory setting 20 rpm) When braking with OFF1 or OFF3, when the speed falls below this threshold, standstill is detected and the monitoring time p1227 or p1228 is started
p1227	<b>Stationary state detection monitoring time</b> (factory setting 300 s)
p1228	<b>Pulse deletion delay time</b> (factory setting 0.01 s)
p1351	<b>Starting frequency, motor holding brake</b> (factory setting 0%) Setting the frequency set value at the slip compensation output when starting with motor holding brake. When the parameter p1351 is set to > 0, slip compensation is automatically switched on.
p1352	<b>Starting frequency for motor holding brake</b> (factory setting 1351) Setting the signal source for the frequency set value at the slip compensation output when starting with motor holding brake.
p1475	<b>Speed controller torque set value for motor holding brake</b> (factory setting 0) Setting the signal source for the torque set value when starting with motor holding brake.

### 6.7.5 Flying restart – switching on while the motor is running

If you switch on the motor while it is still rotating, without the "Flying restart" function, there is a high probability that a fault will occur as a result of overcurrent (F30001 or F07801). Examples of applications involving an unintentionally rotating motor directly before switching on:

- The motor rotates after a brief line interruption.
- A flow of air turns the fan impeller.
- A load with a high moment of inertia drives the motor.

#### Principle of operation

The "Flying restart" function comprises the following steps:

1. After the on command, the inverter impresses the search current in the motor and increases the output frequency.
2. When the output frequency reaches the actual motor speed, the inverter waits for the motor excitation build up time.
3. The inverter accelerates the motor to the actual speed setpoint.

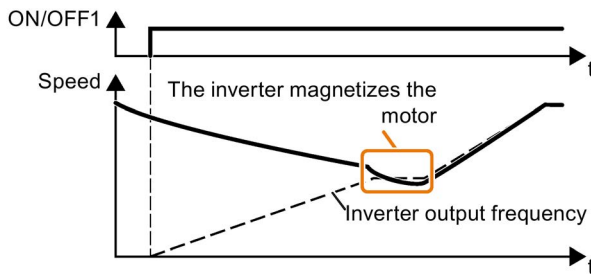

Image 6-49 Principle of operation of the "flying restart" function

#### Setting "flying restart" function

Parameter	Description	
p1200	<b>Flying restart operating mode</b> (factory setting: 0)	
	0	Flying restart is disabled
	1	Flying restart is enabled, search for the motor in both directions, start in the direction of the setpoint
	4	Flying restart is enabled, search for the motor only in the direction of the setpoint

#### No "Flying restart" function for group drives

It is not permissible that you enable the "Flying restart" function if the inverter is simultaneously driving several motors.

Exception: a mechanical coupling ensures that all of the motors always operate with the same speed.

Table 6- 44 Advanced settings

<b>Parameter</b>	<b>Description</b>
p0346	<b>Motor excitation build up time</b> Wait time between switching on the motor and enabling the ramp-function generator.
p0347	<b>Motor de-excitation time</b> Within the motor de-excitation time, after an OFF command, the inverter prevents the induction motor from being switched on again. When using a reluctance motor, the inverter ignores the motor de-excitation time.
p1201	<b>Flying restart enable signal source</b> (factory setting: 1) Defines a control command, e.g. a digital input, which enables the flying restart function.
p1202	<b>Flying restart search current</b> (Factory setting depends on the Power Module) Defines the search current with respect to the magnetizing current (r0331), which flows in the motor during the flying restart.
p1203	<b>Flying restart search current factor</b> (Factory setting depends on the Power Module) The value influences the speed with which the output frequency is changed during the flying restart. A higher value results in a longer search time. If the inverter does not find the motor, reduce the search speed (increase p1203).

### 6.7.6 Automatic restart

The automatic restart includes two different functions:

- The inverter automatically acknowledges faults.
- After a fault occurs or after a power failure, the inverter automatically switches-on the motor again.

The inverter interprets the following events as power failure:

- The inverter signals fault F30003 (DC-link undervoltage), as the line supply voltage of the inverter has briefly failed.
- The inverter power supply fails for a long enough time so that the inverter has been switched-off.

**! WARNING**

**Danger to life as a result of machine parts unexpectedly starting**

When the "automatic restart" function is active (p1210 > 1), the motor automatically starts after a power failure. Unexpected movement of machine parts can result in serious injury and material damage.

- Block off hazardous areas within the machine to prevent inadvertent access.

### Setting the automatic restart function

If it is possible that the motor is still rotating for a longer period of time after a power failure or after a fault, then you must also activate the "flying restart" function.

 Flying restart – switching on while the motor is running (Page 298)

Using p1210, select the automatic restart mode that best suits your application.

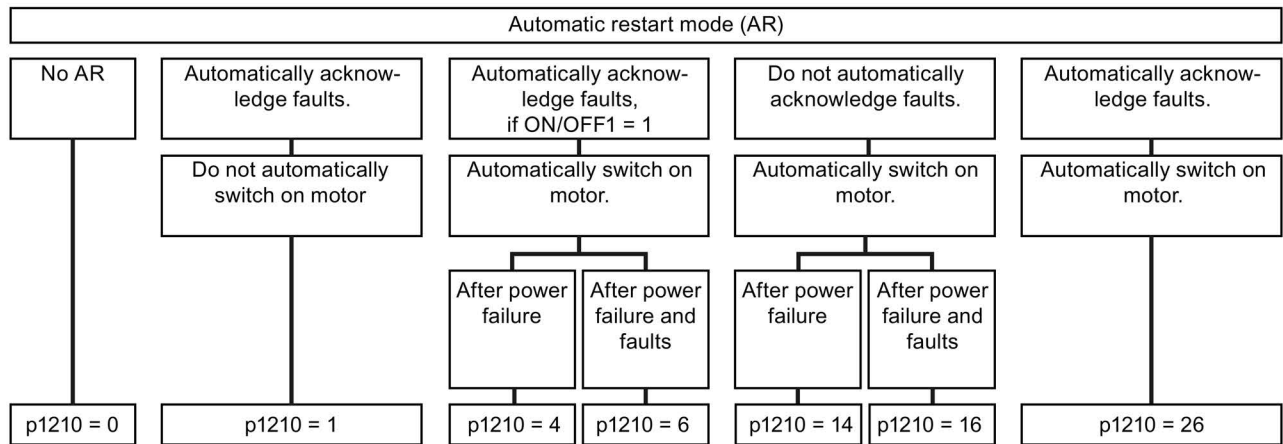
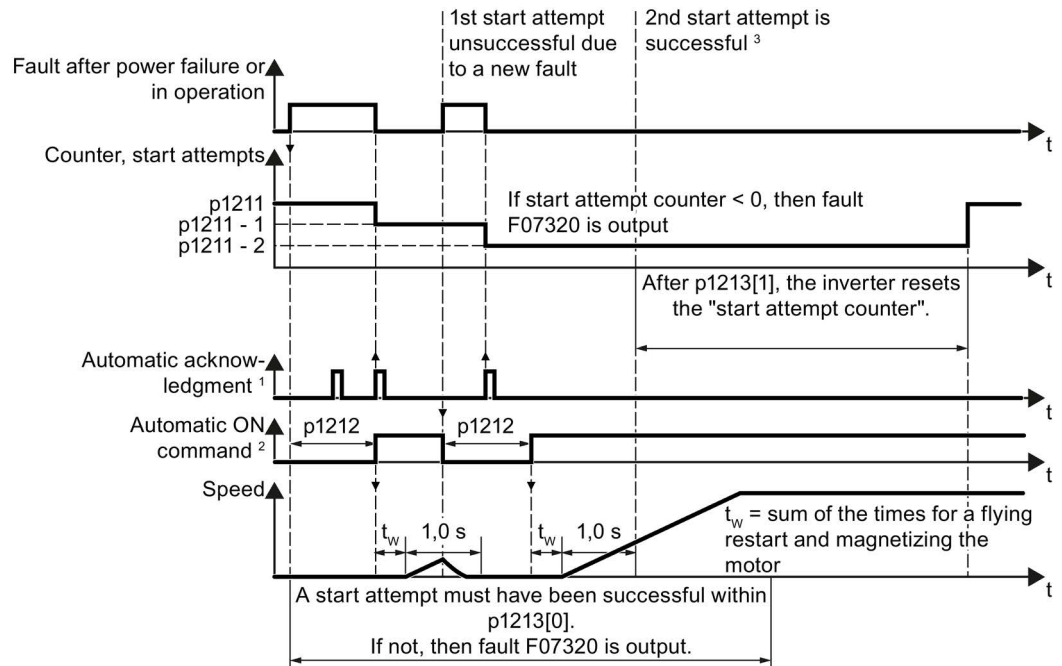

Image 6-50 Automatic restart modes



The principle of operation of the other parameters is explained in the following diagram and in the table below.



<sup>1)</sup> The inverter automatically acknowledges faults under the following conditions:

- p1210 = 1 or 26: Always.
- p1210 = 4 or 6: If the command to switch-on the motor is available at a digital input or via the fieldbus (ON/OFF1 = 1).
- p1210 = 14 or 16: Never.

<sup>2)</sup> The inverter attempts to automatically switch the motor on under the following conditions:

- p1210 = 1: Never.
- p1210 = 4, 6, 14, 16, or 26: If the command to switch-on the motor is available at a digital input or via the fieldbus (ON/OFF1 = 1).

<sup>3)</sup> If, after a flying restart and magnetization ( $r0056.4 = 1$ ) no fault occurs within one second, then the start attempt was successful.

Image 6-51 Time response of the automatic restart

**Parameter for setting the automatic restart**

Parameter	Explanation
p1210	<p><b>Automatic restart mode</b> (factory setting: 0)</p> <p>0: Disable automatic restart.                      1: Acknowledge all faults without restarting.                      4: Restart after power failure without further restart attempts.                      6: Restart after fault with further restart attempts.                      14: Restart after power failure after manual acknowledgement.                      16: Restart after fault after manual acknowledgement.                      26: Acknowledgement of all faults and restart with ON/OFF1 = 1 command.</p>
p1211	<p><b>Automatic restart start attempts</b> (factory setting: 3)</p> <p>This parameter is only effective for the settings p1210 = 4, 6, 14, 16, 26.</p> <p>You define the maximum number of start attempts using p1211. After each successful acknowledgement, the inverter decrements its internal counter of start attempts by 1.</p> <p>p1211 = 0 or 1: The inverter only tries to start once. After an unsuccessful start attempt, the inverter issues fault F07320.</p> <p>p1211 = n, n &gt; 1: The inverter tries to start n-times. The inverter outputs fault F07320 if the nth starting attempt was unsuccessful.</p> <p>The inverter sets the start attempt counter back again to the value of p1211, if one of the following conditions is fulfilled:</p> <ul style="list-style-type: none"> <li>• After a successful start attempt, the time in p1213[1] has expired.</li> <li>• After fault F07320, switch off the motor (OFF1) and acknowledge the fault.</li> <li>• You change the start value p1211 or the mode p1210.</li> </ul>
p1212	<p><b>Automatic restart wait time start attempt</b> (factory setting: 1.0 s)</p> <p>This parameter is only effective for the settings p1210 = 4, 6, 26.</p> <p>Examples for setting this parameter:</p> <ol style="list-style-type: none"> <li>1. After a power failure, a certain time must elapse before the motor can be switched-on, e.g. because other machine components are not immediately ready. In this case, set p1212 longer than the time, after which all of the fault causes have been removed.</li> <li>2. In operation, the inverter develops a fault condition. The lower you select p1212, then the sooner the inverter attempts to switch-on the motor again.</li> </ol>

Parameter	Explanation
p1213[0]	<p><b>Automatic restart monitoring time for restart</b> (factory setting: 60 s)</p> <p>This parameter is only effective for the settings p1210 = 4, 6, 14, 16, 26.</p> <p>With this monitoring function, you limit the time in which the inverter may attempt to automatically switch-on the motor again.</p> <p>The monitoring function starts when a fault is identified and ends with a successful start attempt. If the motor has not successfully started after the monitoring time has expired, fault F07320 is signaled.</p> <p>Set the monitoring time longer than the sum of the following times:</p> <ul style="list-style-type: none"> <li>+ p1212</li> <li>+ Time that the inverter requires to start the motor on the fly.</li> <li>+ Motor magnetizing time (p0346)</li> <li>+ 1 second</li> </ul> <p>You deactivate the monitoring function with p1213 = 0.</p>
p1213[1]	<p><b>Automatic restart monitoring time to reset the fault counter</b> (factory setting: 0 s)</p> <p>This parameter is only effective for the settings p1210 = 4, 6, 14, 16, 26.</p> <p>Using this monitoring time, you prevent that faults, which continually occur within a certain time period, are automatically acknowledged each time.</p> <p>The monitoring function starts with a successful start attempt and ends after the monitoring time has expired.</p> <p>If, during the monitoring time p1213[1], the inverter made more successful starting attempts than defined in p1211, the inverter interrupts the automatic restart function and signals fault F07320. To switch on the motor again you must acknowledge the fault and switch on the inverter (ON/OFFS1 = 1).</p>

Additional information is provided in the parameter list of the List Manual.

### Advanced settings

If you wish to suppress the automatic restart function for certain faults, then you must enter the appropriate fault numbers in p1206[0 ... 9].

Example: p1206[0] = 07331 → No restart for fault F07331.

Suppressing the automatic restart only functions for the setting p1210 = 6, 16 or 26.

 <b>WARNING</b>
<p><b>Danger to life if an OFF command has no effect.</b></p> <p>When the inverter is only controlled via the fieldbus interface, the motor restarts with the setting p1210 = 6, 16, 26 – even if the communication link is currently interrupted. When communication is interrupted, the control system cannot switch off the motor.</p> <ul style="list-style-type: none"> <li>• Enter the fault number of the communication error in parameter p1206.</li> </ul> <p>Example: Fault number F01910 means: Communication via PROFIBUS failed. Set p1206[n] = 1910 (n = 0 ... 9).</p>

### 6.7.7 Kinetic buffering (V<sub>dc</sub> min control)

Kinetic buffering increases the drive availability. The kinetic buffering utilizes the kinetic energy of the load to buffer line dips and failures. During a line dip, the inverter keeps the motor in the switched-on state for as long as possible. One second is a typical, maximum buffer time.

#### Preconditions

The following prerequisites must be fulfilled to practically use the "kinetic buffering" function:

- The driven load has a sufficiently high inertia.
- The application allows a motor to be braked during a power failure.

#### Function

When the line supply dips or is interrupted, the DC link voltage in the inverter decreases. At an adjustable threshold, kinetic buffering intervenes (V<sub>DC min</sub> control). The V<sub>DC min</sub> control forces the load to go into slightly regenerative operation. As a consequence, the inverter covers its power loss and the losses in the motor with the kinetic energy of the load. The load speed decreases; however, during kinetic buffering, the DC voltage remains constant. After the line supply returns, the inverter immediately resumes normal operation.

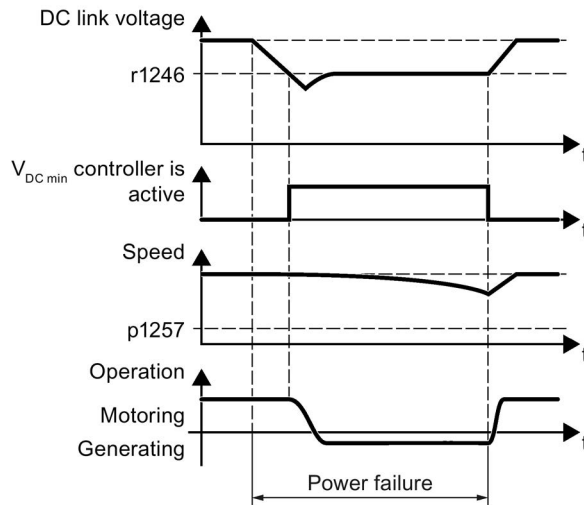

Image 6-52 Principle mode of operation of kinetic buffering

Parameter	Description	
r0056.15	<b>Status word closed-loop control</b>	
	0 signal	V <sub>DC min</sub> controller is not active
	1 signal	V <sub>DC min</sub> controller is active (kinetic buffering)
p0210	<b>Device supply voltage</b> (factory setting: 400 V)	
p1240	<b>V<sub>DC</sub> controller configuration</b> (factory setting: 1)	
	0	Inhibit V <sub>DC</sub> controller
	1	Enable V <sub>DC max</sub> controller
	2	Enable V <sub>DC min</sub> controller (kinetic buffering)
	3	Enable V <sub>DC min</sub> controller and V <sub>DC max</sub> controller
p1245	<b>V<sub>DC min</sub> controller activation level</b> (kinetic buffering) (factory setting: 76 %)	
r1246	<b>V<sub>DC min</sub> controller activation level[V]</b> r1246 = p1245 × √2 × p0210	
p1247	<b>V<sub>DC min</sub> controller dynamic factor</b> (factory setting: 300 %)	
p1255	<b>V<sub>DC min</sub> controller time threshold</b> (factory setting: 0 s)	
	Maximum duration of the kinetic buffering. If kinetic buffering lasts longer than that specified in the parameter value, the inverter outputs fault F7406. A value of 0 deactivates the monitoring.	
p1257	<b>V<sub>DC min</sub> controller speed threshold</b> (factory setting: 50 rpm)	
	When fallen below, the inverter outputs fault F7405.	

## 6.7.8 Line contactor control

The line contactor control is used to switch on and switch off the power supply voltage for the inverter via a digital output of the inverter. Precondition is an external 24 V power supply for the inverter CU.

You can monitor when the line contactor opens and closes using the feedback signal contact of the contactor.

The function has the advantage that you only switch on the line voltage for the inverter briefly before the motor must be switched on. If the motor is switched off, after an adjustable wait time, the line voltage for the inverter is switched off again.

This means that you reduce the inverter losses for the times when the motor is not operational.

### Activate line contactor control

You activate the line contactor control by interconnecting the signal source of a digital output of the inverter (depending on the particular inverter, p0730 ... p0741) with the signal to control the line contactor (r0863.1). For example: p0732 = 863.1.

#### Line contactor control without monitoring - factory setting:

In the factory setting, the function for a line contactor without feedback signal contact is set. The feedback signal is linked with the signal to control the line contactor: p0860 = 863.1.

For an OFF1, the line contactor opens after the delay time setting in p0867.

#### Line contactor control with monitoring:

If you use a line contactor with feedback signal contact, activate the feedback signal by linking the parameter for the feedback signal - p0860 -with the inverted signal of a digital input: p0860 = 723.x.

If monitoring is active, when switching off or switching on, message F07300 is output, if, after the time set in p0861 no feedback signal is received via r723.x.

In addition for inverters with STO: Sequence control via p0869

Using p0869, you set whether the line contactor immediately opens for an STO signal, or only after the time set in p0867 has expired.

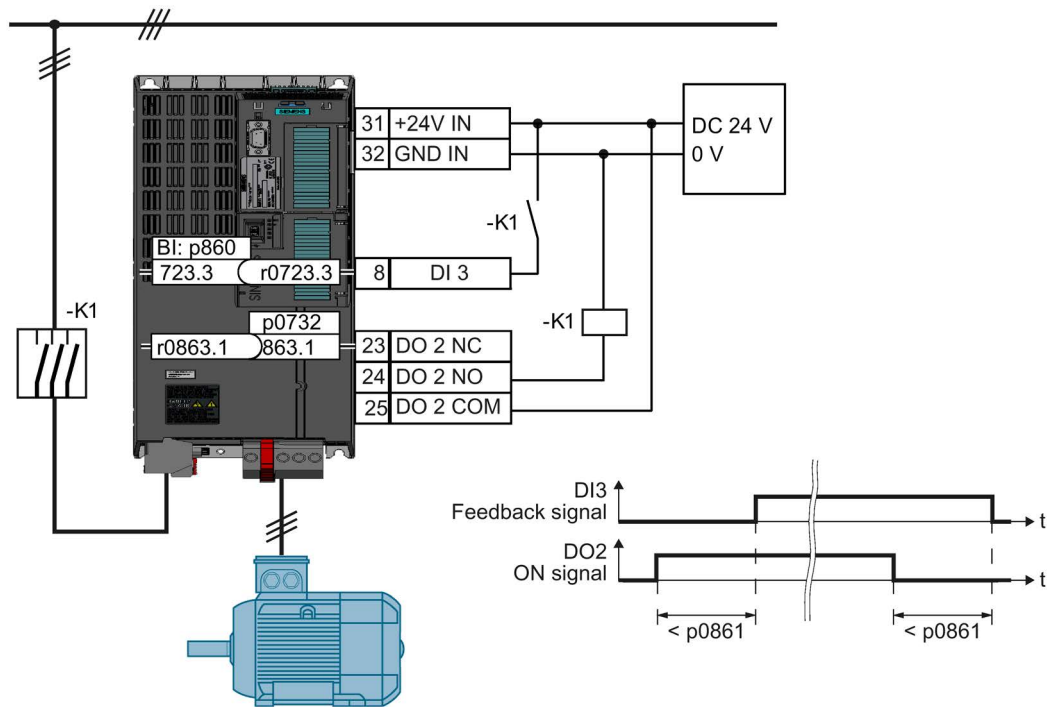

Image 6-53 Line contactor control with monitoring

### Parameter to set the line contactor control

Parameter	Explanation
p0860	<b>Line contactor feedback signal</b> <ul style="list-style-type: none"> <li>p0860 = 863.1: No feedback signal</li> <li>p0860 = 723.x: Feedback signal via DIx</li> </ul>
p0861	<b>Line contactor monitoring time</b> (Factory setting: 100 ms) Fault F07300 is output if, for an activated feedback signal, no feedback signal is received via the selected digital input after the time set here has expired.
r0863.1	<b>Drive coupling status/control word</b> Bit to activate the line contactor control: Assign 863.1 to DO x, Example: Control line contactor via digital output DO 2: p0732 = 863.1
p0867	<b>Main contactor holding time after OFF1</b> (Factory setting: 50 ms) Time where, after an OFF1, the main contactor remains closed.
p0869	<b>Sequence control configuration</b> <ul style="list-style-type: none"> <li>p0689 = 0: Line contactor opens immediately for an STO</li> <li>p0689 = 1: For an STO, the line contactor opens after the time set in p0867 has expired</li> </ul>

### 6.7.9 PID technology controller

The technology controller controls process variables, e.g. pressure, temperature, level or flow.

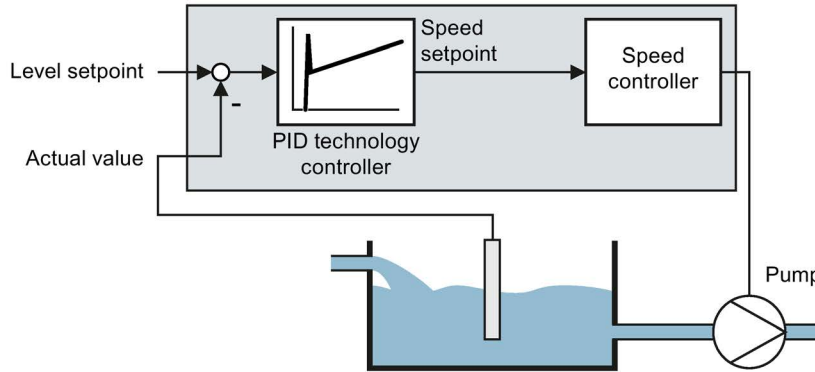
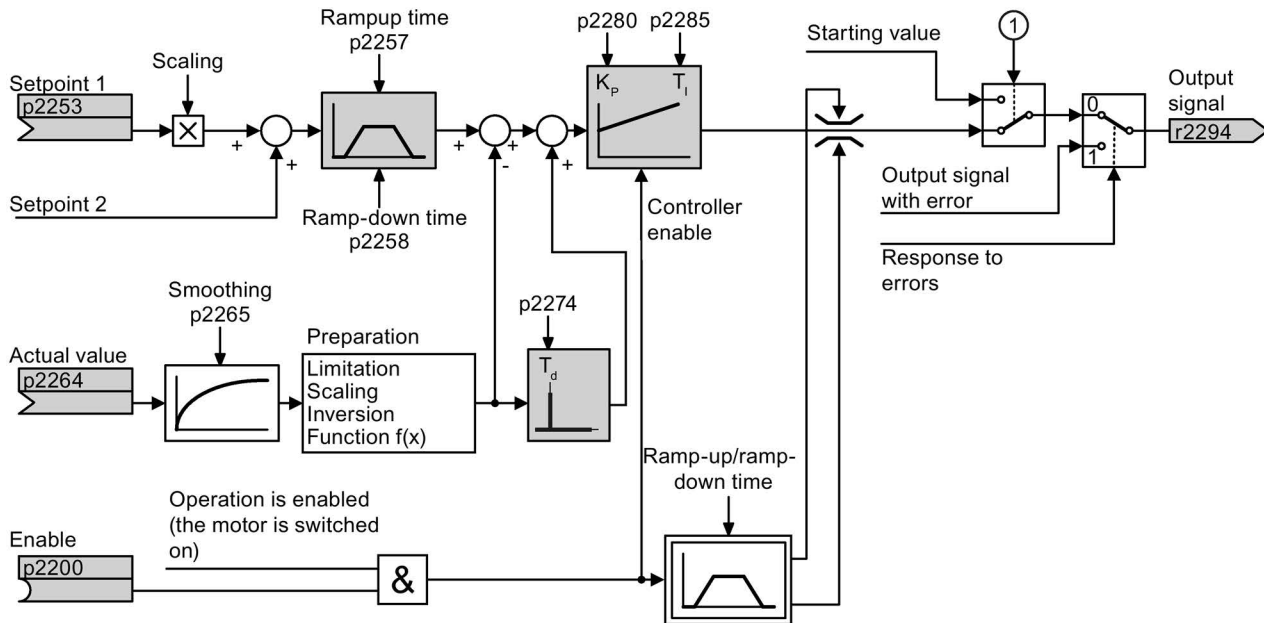

Image 6-54 Example: Technology controller as a level controller

### Simplified representation of the technology controller

The technology controller is implemented as a PID controller (controller with proportional, integral, and derivative action).



- ① The inverter uses the start value when all the following conditions are simultaneously satisfied:
- The technology controller supplies the main setpoint (p2251 = 0).
  - The ramp-function generator output of the technology controller has not yet reached the start value.

Image 6-55 Simplified representation of the technology controller



The settings required as a minimum are marked in gray in the function diagram: Interconnect setpoint and actual values with signals of your choice, set the ramp-function generator and controller parameters  $K_P$ ,  $T_I$  and  $T_d$ .

Further information about the following PID controller topics is available in the Internet:

- Setpoint specification: Analog value or fixed setpoint
- Setpoint channel: Scaling, ramp-function generator and filter
- Actual value channel: Filter, limiting and signal processing
- PID controller Principle of operation of the D component, inhibiting the I component and the control sense
- Enable, limiting the controller output and fault response



FAQ (<http://support.automation.siemens.com/WW/view/en/92556266>)

## Setting the technology controller

Parameter	Remark
p2200	<b>BI: Technology controller enable</b> (factory setting: 0) 1 signal: Technology controller is enabled.
r2294	<b>CO: Technology controller output signal</b> To interconnect the main speed setpoint with the technology controller output, set p1070 = 2294.
p2253	<b>CI: Technology controller setpoint 1</b> (factory setting: 0) Setpoint for the technology controller. Example: p2253 = 2224: The inverter interconnects the fixed setpoint p2201 with the setpoint of the technology controller. p2220 = 1: The fixed setpoint p2201 is selected.
p2264	<b>CI: Technology controller actual value</b> (factory setting: 0) Technology controller actual value.
p2257, p2258	<b>Technology controller ramp-up time and ramp-down time</b> (factory setting: 1 s)
p2274	<b>Technology controller differentiation time constant <math>T_d</math></b> (factory setting: 0.0 s) The differentiation improves the rise time for very slow controlled variables, e.g. a temperature control.
p2280	<b>Technology controller proportional gain <math>K_P</math></b> (factory setting: 1,0)
p2285	<b>Technology controller integration time (integral time) <math>T_i</math></b> (factory setting: 30 s)

## Advanced settings

Parameter	Remark
<b>Limiting the output of the technology controller</b>	
In the factory setting, the output of the technology controller is limited to $\pm$ maximum speed. You must change this limit, depending on your particular application. Example: The output of the technology controller supplies the speed setpoint for a pump. The pump should only run in the positive direction.	
p2297	<b>CI: Technology controller maximum limiting signal source</b> (factory setting: 1084)
p2298	<b>CI: Technology controller minimum limiting signal source</b> (factory setting: 2292)
p2291	<b>CO: Technology maximum limiting</b> (factory setting: 100 %)
p2292	<b>CO: Technology minimum limiting</b> (factory setting: 0 %)
<b>Manipulating the actual value of the technology controller</b>	
p2267	<b>Technology controller upper limit actual value</b> (factory setting: 100 %)
p2268	<b>Technology controller lower limit actual value</b> (factory setting: -100 %)
p2269	<b>Technology controller gain actual value</b> (factory setting: 100 %)
p2271	<b>Technology controller actual value inversion (sensor type)</b>
	0: No inversion
	1: Inversion actual value signal If the actual value decreases with increasing motor speed, then p2271 must be set = 1.
p2270	<b>Technology controller actual value function</b>
	0: No function
	1: $\sqrt{\quad}$
	2: $x^2$
	3: $x^3$

For further information refer to the function block diagrams 7950 ff of the List Manual.

## Autotuning of the PID controller

Autotuning is an inverter function for the automatic optimization of the PID controller.

For active autotuning, the inverter interrupts the connection between the PID controller and the speed controller. Rather than the PID controller output, the autotuning function provides the speed setpoint.

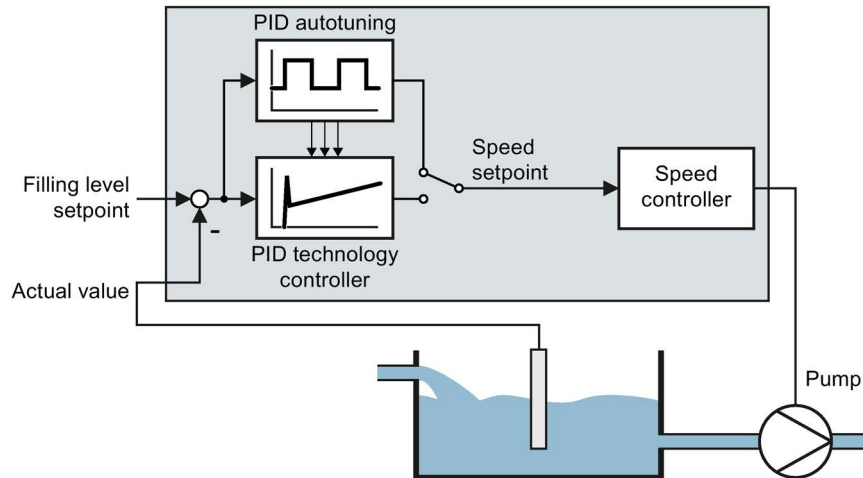

Image 6-56 Autotuning of the PID controller using the example of a filling-level control

The speed setpoint results from the technology setpoint and a superimposed rectangular signal with amplitude  $p2355$ . If actual value = technology setpoint  $\pm p2355$ , the autotuning function switches the polarity of the superimposed signal. This causes the inverter to excite the process variable for an oscillation.

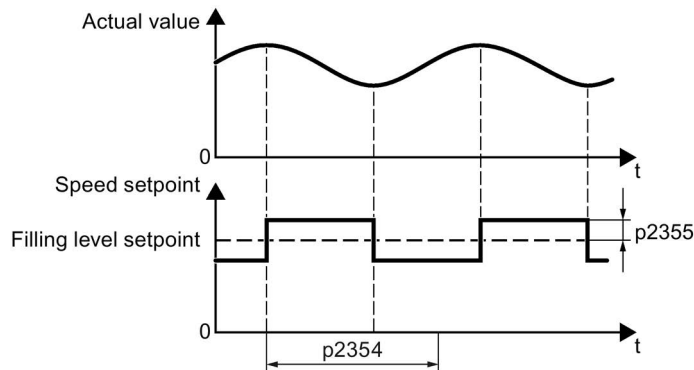

Image 6-57 Example for speed setpoint and actual process value for autotuning

The inverter calculates the parameters of the PID controller from the determined oscillation frequency.

## Autotune the PID controller

### Requirements

The PID technology controller must be set the same as when used in subsequent operation:

- The actual value is interconnected.
- Scalings, filter and ramp-function generator have been set.
- The PID technology controller is enabled (p2200 = 1 signal)

### Procedure



Proceed as follows to auto tune the PID controller:

1. Select with p2350 the appropriate controller setting.
2. Switch on the motor.

The inverter signals Alarm A07444.

3. Wait until alarm A07444 goes away.

The inverter has recalculated parameters p2280, p2274 and p2285.





If the inverter signals fault F07445:

- If possible, double p2354 and p2355.
- Repeat the autotuning with the changed parameters.

4. Back up the calculated values so that they are protected against power failure, e.g. using the BOP-2: OPTIONS → RAM-ROM.

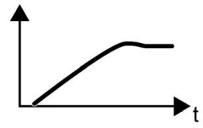

You have auto tuned the PID controller.

Parameter	Remark	
p2350	<b>PID Autotune Enable</b> (Factory setting: 0) Automatic controller setting based on the "Ziegler Nichols" method. After completion of the autotuning, the inverter sets p2350 = 0.	
	0: No function	
	1: Controller setting after completion of the autotuning: The process variable follows the setpoint after a sudden setpoint change (step function) relatively quickly, however with an overshoot.	
	2: Faster controller setting than for p2350 = 1 with larger overshoot of the controlled variable.	
	3: Slower controller setting than for p2350 = 1. Overshoot of the controlled variable is, to a large extent, avoided.	
4: Controller setting after completion of the autotuning as for p2350 = 1. Optimize only the P and I action of the PID controller.		
p2354	<b>PID tuning timeout length</b> (Factory setting: 240 s) Monitoring time for the process response. p2354 must be greater than half the time period of the process variable oscillation.	
p2355	<b>PID tuning offset</b> (Factory setting: 5%) Autotuning offset. p2355 must be sufficiently large so that the amplitude of the process variable oscillation signal can be differentiated from any superimposed noise.	

Setting the technology controller without autotuning (manual)

Procedure



1 Proceed as follows to manually set the technology controller:

1. Temporarily set the ramp-up and ramp-down times of the ramp-function generator (p2257 and p2258) to zero.
2. Enter a setpoint step and monitor the associated actual value, e.g. with the trace function of STARTER.

The slower the response of the process to be controlled, the longer you must monitor the controller response. Under certain circumstances (e.g. for a temperature control), you need to wait several minutes until you can evaluate the controller response.

	<p>Optimum controller response for applications that do not permit any overshoot. The actual value approaches the setpoint without any significant overshoot.</p>
	<p>Optimum controller behavior for fast correction and quick compensation of disturbance components. The actual value approaches the setpoint and slightly overshoots, maximum 10% of the setpoint step.</p>
	<p>The actual value only slowly approaches the setpoint.</p> <ul style="list-style-type: none"> <li>• Increase the proportional component <math>K_P</math> and reduce the integration time <math>T_I</math>.</li> </ul>
	<p>Actual value only slowly approaches the setpoint with slight oscillation.</p> <ul style="list-style-type: none"> <li>• Increase the proportional component <math>K_P</math> and reduce the rate time <math>T_d</math> (differentiating time).</li> </ul>
	<p>The actual value quickly approaches the setpoint, but overshoots too much.</p> <ul style="list-style-type: none"> <li>• Decrease the proportional component <math>K_P</math> and increase the integration time <math>T_I</math>.</li> </ul>

3. Set the ramp-up and ramp-down times of the ramp-function generator back to their original value.



You have now manually set the technology controller.

## 6.7.10 System protection

In many applications, monitoring the motor speed and torque provides information about the plant or system status. By setting the appropriate responses in the case of faults, failures and damage to the plant or system can be avoided.

Examples:

- For fans or conveyor belts, an excessively low torque can mean a broken drive belt.
- For pumps, an excessively low torque down to zero speed can mean an inadmissible operating state.
- For extruders and mixers, excessively high torque can mean overload or a blocked machine.

### System protection functions

The inverter offers the following options of monitoring the motor load torque and speed:

- No-load monitoring
- Blocking protection
- Stall protection
- Load monitoring

No-load monitoring, blocking protection and stall protection require just a few settings. However, the load monitoring is a function that offers a wide range of different setting options – which in turn demands that you have good knowledge of the system.

### 6.7.10.1 No-load monitoring, blocking protection, stall protection

#### No-load monitoring

##### Principle of operation

If the motor current is below the value of p2179 for the time set in p2180, using bit 11 of status word 1 for monitoring functions (r2197.11), the converter outputs the "Output load not available" message.

Applications: Fans and conveyor belts

##### Settings

Parameters	Description
p2179	<b>Output load detection current limit</b> (factory setting: 0 A) p2179 = 0: No load detection deactivated
p2180	<b>Output load detection delay time</b> (factory setting: 2000 ms)

#### Stall protection

##### Principle of operation

If the speed lies below the value of p2175 for the time set in p2177, and the converter is operating at the current or torque limit, using bit 6 of status word 2 for monitoring functions (r2198.6), the converter outputs the "Motor blocked" message.

The converter goes to the current or torque limit if the setpoint speed is significantly higher than the actual speed.

Applications: Extruders and mixers

##### Settings

Parameters	Description
p2175	<b>Motor blocked speed threshold</b> (factory setting: 120 rpm) p2175 = 0: Blocking protection deactivated
p2177	<b>Motor blocked delay time</b> (factory setting: 3 s)



## Stall protection

### Principle of operation

If the value in r1746 exceeds the value of p1745 for the time set in p2178, using bits 7 of status word 2, for monitoring functions (r2198.7) the converter outputs the "Motor stalled" message.

Applications: General system protection

### Settings

Parameters	Description
p1745	<b>Motor model fault threshold value stall detection</b> (factory setting: 5 %) If the motor stalls too early with this setting, then using the trace function you have the option of determining a better value. To do this, set p1745 = 100.
p2178	<b>Motor stalled delay time</b> (factory setting: 0.01 s)

### 6.7.10.2 Load monitoring

The load monitoring comprises the following components:

- Load failure monitoring
- Monitoring for torque deviation
- Speed deviation monitoring
- Pump monitoring
- Fan monitoring

If the load monitoring detects load failure, then the inverter always goes into a fault condition and outputs fault F07936. For a torque and speed deviation, as response, you can either set an alarm or a fault. Details are provided in the following descriptions.

#### Settings

Table 6- 45 Setting options for load monitoring

Parameters	Description
p2193	<b>Load monitoring configuration</b> (factory setting: 1) 0: Monitoring deactivated 1: Torque and load failure monitoring 2: Speed deviation and load failure monitoring 3: Monitoring, load failure 4: Pump monitoring 5: Fan monitoring

### Load failure monitoring

#### Principle of operation

Using this function, the inverter monitors the speed or velocity of a machine component. The inverter evaluates whether an encoder signal is present. If the encoder signal fails for a time that can be adjusted, then the inverter signals a fault.

Examples of how the function can be used:

- Gearbox monitoring for traction drives and hoisting gear
- Drive belt monitoring for fans and conveyor belts
- Blocking protection for pumps and conveyor belts

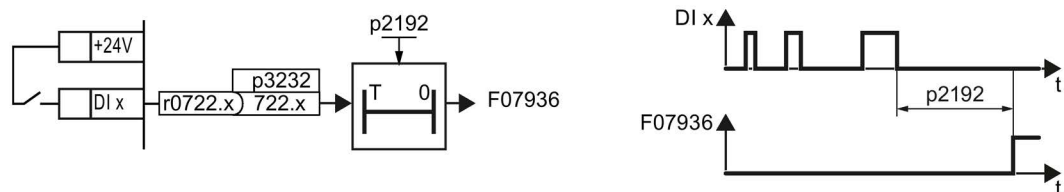



Image 6-58 Function plan and time response of load-interruption monitoring

## Settings

Parameter	Description
p2192	<b>Load monitoring delay time</b> (factory setting 10 s) After the motor is switched on, if the "LOW" signal is present at the associated digital input for longer than this time, the inverter signals a load failure (F07936).
p2193 = 3	<b>Load monitoring configuration</b>  Table 6-45 Setting options for load monitoring (Page 318)
p3232 = 722.x	<b>Load monitoring failure detection</b> (factory setting: 1) Connect the load monitoring to a DI x digital input of your choice.

For more information, see the List Manual (the parameter list and function diagram 8013).

## Monitoring for torque deviation

Based on the envelope curve shown below and dependent on the speed, the torque is monitored against a lower and upper torque. The inverter linearly interpolates the intermediate values.

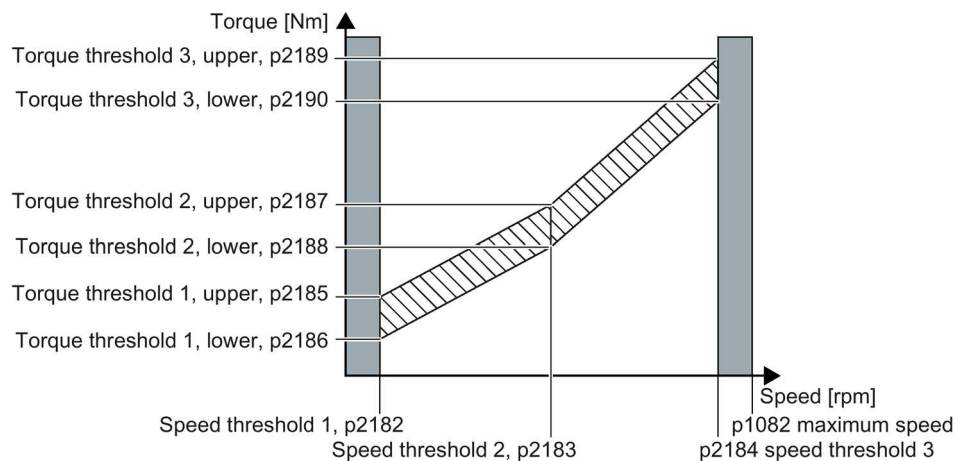



## Principle of operation

The inverter monitors the motor torque for speeds between threshold value 1 and threshold value 3.

If the torque lies outside the envelope curve for longer than the time set in p2192, then the response defined in p2181 is initiated.

The torque is not monitored for speeds between 0 and speed threshold 1 (p2182) - as well as between speed threshold 3 (p2184 and the maximum speed (p1082).

**Settings**

Parameters	Description
p2181	<b>Load monitoring response</b> Response when evaluating the load monitoring. Setting options  Table 6-46 Response options for load monitoring (Page 325)
p2182	<b>Load monitoring speed threshold 1</b>
p2183	<b>Load monitoring speed threshold 2</b>
p2184	<b>Load monitoring speed threshold 3</b>
p2185	<b>Load monitoring torque threshold 1, upper</b>
p2186	<b>Load monitoring torque threshold 1, lower</b>
p2187	<b>Load monitoring torque threshold 2, upper</b>
p2188	<b>Load monitoring torque threshold 2, lower</b>
p2189	<b>Load monitoring torque threshold 3, upper</b>
p2190	<b>Load monitoring torque threshold 3, lower</b>
p2192	<b>Load monitoring delay time</b> Delay time for the message "Leave torque monitoring tolerance band"
p2193 = 1	<b>Load monitoring configuration</b> (factory setting: 1)  Table 6-45 Setting options for load monitoring (Page 318)

## Speed deviation monitoring

Using this function, the inverter calculates and monitors the speed or velocity of a machine component. The inverter analyzes an encoder signal, calculates a speed from the signal, compares it to the motor speed and reports any excessive deviation between the encoder signal and the motor speed.

Examples of how the function can be used:

- Gearbox monitoring for traction drives and hoisting gear
- Drive belt monitoring for fans and conveyor belts
- Blocking protection for conveyor belts

You require a transmitter for this function, e.g. a proximity switch. The inverter analyzes an encoder signal at max. 32 kHz.

The function is only available with the CU240E-2 Control Unit via digital input DI 3.

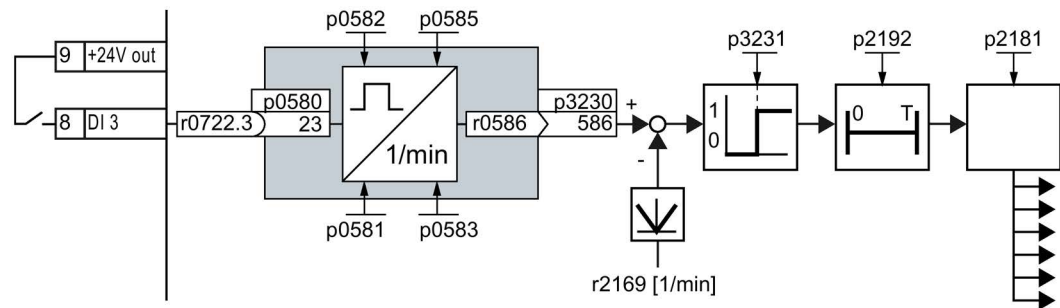

Image 6-59 Speed deviation monitoring

### Principle of operation

The inverter determines the speed deviation from the calculated speed r0586 and the speed list value r2169. p2181 determines the response of the inverter if the deviation is excessive.

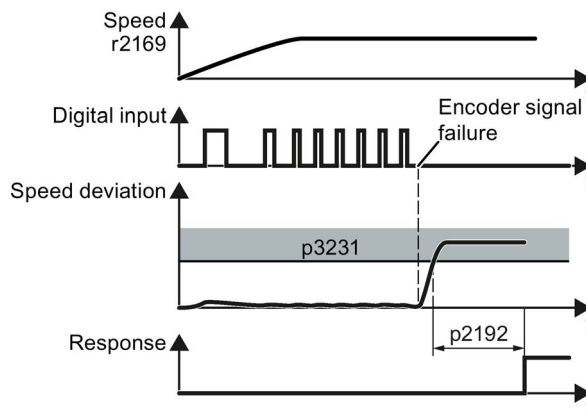



Image 6-60 Time response of monitoring speed deviation

## Settings

Parameter	Description
p0490	<b>Invert probe</b> <sup>1)</sup> (factory setting 0000bin) Using the 3rd bit of the parameter value, invert the input signals of digital input 3 for the probe.
p0580	<b>Probe</b> <sup>1)</sup> <b>Input terminal</b> (factory setting 0) Connect input of probe with a digital input.
p0581	<b>Probe</b> <sup>1)</sup> <b>Edge</b> (factory setting 0) Edge for analyzing the probe signal for measuring speed list value 0: 0/1 edge 1: 1/0 edge
p0582	<b>Probe</b> <sup>1)</sup> <b>Pulse per revolution</b> (factory setting 1) Number of pulses per revolution
p0583	<b>Probe</b> <sup>1)</sup> <b>Maximum measurement time</b> (factory setting 10 s) Maximum measurement time for the probe. If there is no new pulse before the maximum measuring time elapses, the inverter sets the actual speed value in r0586 to zero. The time is restarted with the next pulse.
p0585	<b>Probe</b> <sup>1)</sup> <b>Gear ratio</b> (factory setting 1) The inverter multiplies the measured speed by the gear ratio before displaying it in r0586.
r0586	<b>Probe</b> <sup>1)</sup> <b>Speed list value</b> Result of the speed calculation
p2181	<b>Load monitoring response</b> Response when evaluating the load monitor.  Table 6-46 Response options for load monitoring (Page 325)
p2192	<b>Load monitoring delay time</b> (factory setting 10 s) Delay time for evaluating load monitoring.
p2193 = 2	<b>Load monitoring configuration</b>  Table 6-45 Setting options for load monitoring (Page 318)
p3230 = 586	<b>Load monitoring actual speed value</b> (factory setting 0) Result of the speed calculation with the evaluation of the speed monitoring.
p3231	<b>Load monitoring speed deviation</b> (factory setting 150 rpm) Permissible speed deviation of load monitoring.

<sup>1)</sup> The "Probe" subfunction calculates the speed from the pulse signal of the digital input.  
For more information, see the List Manual (the parameter list and function diagram 8013).

## Monitoring, pump/fan

The monitoring functions for pumps and fans are similar. The blocking protection applies equally to both applications.

For pumps, there is also a leakage monitoring function.

### Principle of operation

Within speed thresholds 1 and 3, the inverter monitors the torque and the speed for pumps and fans.

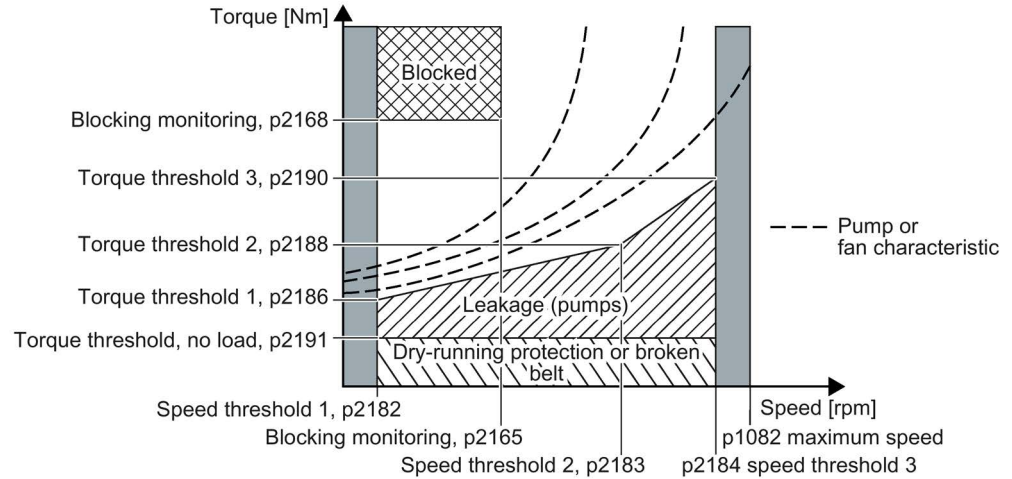

If the torque or the speed moves, for longer than the time set in p2192, in the ranges of blockage, leakage or dry running protection/belt breakage, then the response defined in p2181 is realized.

**Restrictions and general constraints for blocking protection depending on the motor type and control mode**

The following preconditions must be satisfied in order that the blockage monitoring is active for pumps and fans:

- The following applies for application class "Standard Drive Control" (p0096 = 1) or "Expert" (p0096 = 0) and V/f control (p1300 < 10):

Speed actual value > p2182 and > 10% rated speed. A torque actual value r0080 is only calculated in this range.

For active I<sub>max</sub> controller (when the current limit is reached), the blocking protection acts.

 No-load monitoring, blocking protection, stall protection (Page 316)

- For vector control (p1300 = 20) or application class "Dynamic Drive Control" (p0096 = 2), the following always applies:

- Speed setpoint > p1755 switchover speed, motor model
- Speed actual value > p2182 speed threshold 1

In addition, the following applies:

- for induction motors (operated with the vector control)
  - p1750.6 = 1 (when the motor is blocked, the closed-loop control does not change into the open-loop controlled mode) or p2192 < 1 s
- for synchronous and reluctance motors (operated with vector control)
  - p2182 > p1755 switchover speed, motor model
  - With this method, a complete blockage is not detected

**Settings**



Parameters	Description
p2165	Load monitoring blocking monitoring threshold, upper
p2168	Load monitoring blocking monitoring torque threshold
p2181	Load monitoring response Response when evaluating the load monitoring.  Table 6-46 Response options for load monitoring (Page 325)
p2182	Load monitoring speed threshold 1
p2183	Load monitoring speed threshold 2
p2184	Load monitoring speed threshold 3
p2186	Load monitoring torque threshold 1, lower
p2188	Load monitoring torque threshold 2, lower
p2190	Load monitoring torque threshold 3, lower
p2191	Load monitoring torque threshold, no load
p2192	Load monitoring delay time
p2193 = 3	Load monitoring configuration  Table 6-45 Setting options for load monitoring (Page 318)



Table 6- 46 Response options for load monitoring

p2181 = 0	Load monitoring deactivated (factory setting)
p2181 = 1	A07920 for torque/speed too low
p2181 = 2	A07921 for torque/speed too high
p2181 = 3	A07922 for torque/speed out of tolerance
p2181 = 4	F07923 for torque/speed too low
p2181 = 5	F07924 for torque/speed too high
p2181 = 6	F07925 for torque/speed out of tolerance
p2181 = 7	Pump/fan load monitoring as alarm
p2181 = 8	Pump/fan load monitoring as fault

The settings in p2193 for pumps/fans (p2193 = 4 or 5) are only permissible with the settings for load monitoring for pumps/fans (p2181 = 7 or 8)

## 6.7.11 Free function blocks

### 6.7.11.1 Overview

The free function blocks permit configurable signal processing in the inverter.

The following free function blocks are available:

- AND, OR, XOR, and NOT logic
- RSR (RS flip-flop), DSR (D flip-flop) flip-flops
- Timers MFP (pulse generator), PCL (pulse shortening), PDE (ON delay), PDF (OFF delay), and PST (pulse stretching)
- ADD (adder), SUB (subtractor), MUL (multiplier), DIV (divider), AVA (absolute value generated), NCM (comparator), and PLI (polyline) arithmetic functions
- LIM (limiter), PT1 (smoothing), INT (integrator), DIF (differentiator) controllers
- NSW (analog) BSW (binary) switches
- LVM limit value monitoring

The number of free function blocks in the inverter is limited. You can only use a function block once. The inverter has 3 adders, for instance. If you have already configured three adders, then no other adders are available.

### 6.7.11.2 Further information

#### Application description for the free function blocks



Further information is provided in the Internet:

FAQ (<http://support.automation.siemens.com/WW/view/en/85168215>)

## 6.8 Safe Torque Off (STO) safety function



These operating instructions describe the commissioning of the STO safety function when it is controlled via a fail-safe digital input.

You can find a detailed description of all safety functions and their control using PROFIsafe in the "Safety Integrated" function manual.



Overview of the manuals (Page 507)

### 6.8.1 Function description

#### What is the effect of the STO safety function?

The inverter with active STO function prevents energy supply to the motor. The motor can no longer generate torque on the motor shaft.

Consequently, the STO function prevents the starting of an electrically-driven machine component.



Table 6- 47 The STO principle of operation as overview

	Safe Torque Off (STO)	Standard inverter functions linked with STO
1.	The inverter recognizes the selection of STO via a safety-relevant input or via the PROFIsafe safe communication.	---
2.	The inverter prevents the energy supply to the motor.	If you use a motor holding brake, the inverter closes the motor holding brake. If you use a line contactor, the inverter opens the line contactor.
3.	The inverter signals that "STO is active" via a safety-relevant output or via the PROFIsafe safe communication.	---

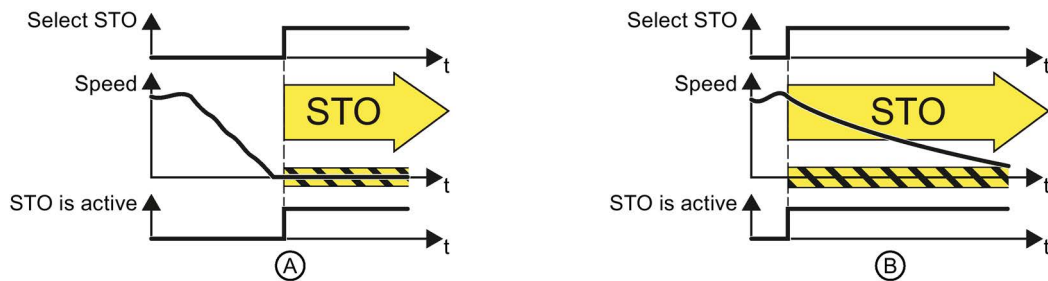

Image 6-61 Functionality of STO when the motor is at standstill (A) and rotating (B)

If the motor is still rotating (B) when STO is selected, it coasts down to standstill.

**The STO safety function is standardized**

The STO function is defined in IEC/EN 61800-5-2:

"[...] [The inverter] does not supply any energy to the motor which can generate a torque (or for a linear motor, a force)".

⇒ The STO inverter function conforms to IEC/EN 61800-5-2.

**The distinction between Emergency Off and Emergency Stop**

"Emergency Off" and "Emergency Stop" are commands that minimize different risks in the machine or plant.

The STO function is suitable for achieving an Emergency Stop but not an Emergency Off.

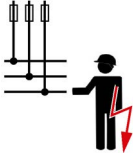
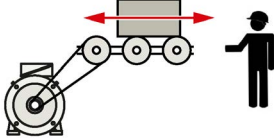
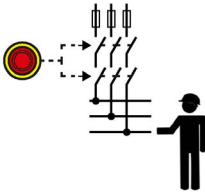
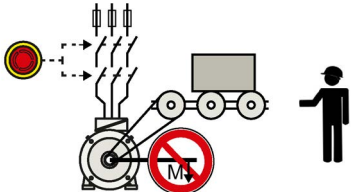
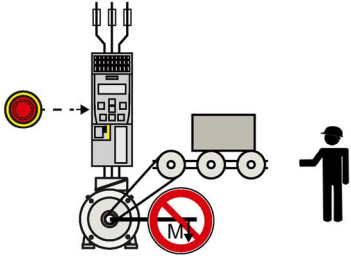
Risk:	Risk of electric shock: 	Risk of unexpected motion: 
Measure to minimize risk:	<b>Safe switch off</b> Switching off the electric power supply for the installation, either completely or partially.	<b>Safely stop and safely prevent re-starting</b> Stopping or preventing the dangerous movement
Command:	<b>Emergency Off</b>	<b>Emergency Stop</b>
Classic solution:	Switch off the power supply: 	Switch off the drive power supply: 
Solution with the STO safety function integrated in the drive:	STO is not suitable for safely switching off an electric voltage.	Select STO:  It is permissible that you switch off the inverter power supply as well. However, switching off the voltage is not required as a risk-reduction measurement.

### Application examples for the STO function

The STO function is suitable for applications where the motor is already at a standstill or will come to a standstill in a short, safe period of time through friction. STO does not shorten the run-on of machine components with high inertia.

Examples	Possible solution
When the Emergency Stop button is pressed, a stationary motor should not unintentionally start.	<ul style="list-style-type: none"> <li>• Wire the Emergency Stop button to a safety-related input of the inverter.</li> <li>• Select STO via the safety-related input.</li> </ul>
A central Emergency Stop button must prevent the unintentional acceleration of several motors that are at a standstill.	<ul style="list-style-type: none"> <li>• Evaluate the Emergency Stop button in a central control.</li> <li>• Select STO via PROFIsafe.</li> </ul>

### 6.8.2 Prerequisite for STO use

In order to use the STO safety function, the machine manufacturer should have already performed a risk assessment, e.g. in compliance with EN ISO 1050, "Safety of machinery - Principles of risk assessment". The risk assessment must confirm that the inverter is permitted for use in accordance with SIL 2 or PL d.

### 6.8.3 Commissioning STO

#### 6.8.3.1 Commissioning tools

We recommend that you commission the safety functions using the STARTER or Startdrive PC tool.

#### 6.8.3.2 Safety functions password

##### What is the purpose of the password?

The password protects the settings of the safety function from being changed by unauthorized persons.

##### Does the password need to be set?

The password does not need to be set.

The machine manufacturer decides whether or not a password is required.

The probabilities of failure (PFH) and the certification of the safety functions also apply when no password has been set.

##### What do I do if I lose the password?

If you no longer know the password but still want to change the settings for safety functions, proceed as follows:

1. Create a new project for the inverter with STARTER or Startdrive.  
Leave all the factory setting in the project.
2. Load the project in the inverter.  
After loading, the inverter has the factory settings.
3. If a memory card inserted in the inverter, remove it.
4. Recommission the inverter.

You can obtain more information or learn about alternative procedures from Technical Support.

No.	Description	
p9761	<b>Entering a password</b> (factory setting 0000 hex)	
	0:	No password set
	1 ... FFFF FFFF:	Password is set
p9762	<b>New password</b>	
p9763	<b>Confirm password</b>	

### 6.8.3.3 Configuring a safety function

#### Procedure with STARTER

- ➔ 1 To configure the safety functions, proceed as follows:
1. Go online.
  2. Select the "Safety Integrated" function
  3. Select "Change settings".

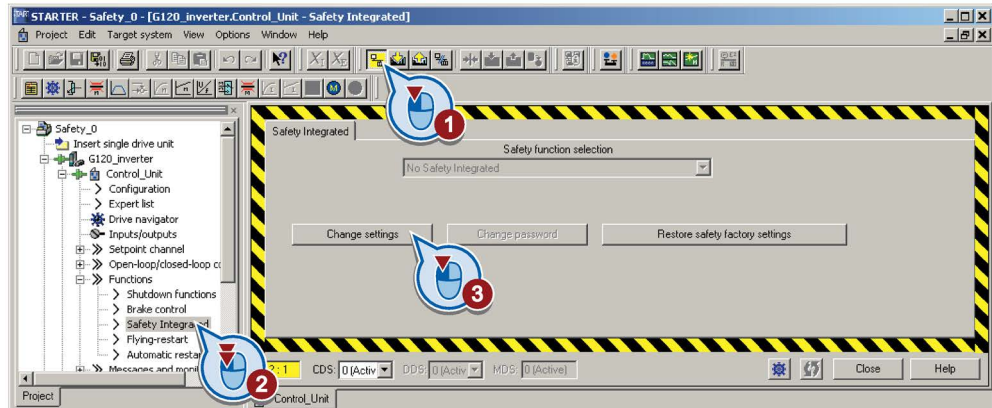

4. Select "STO via terminal":

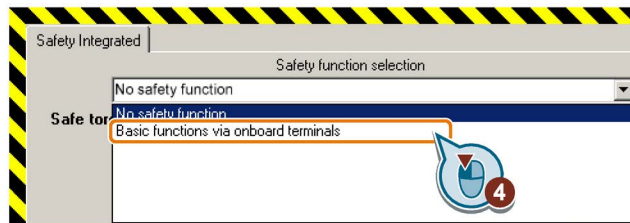

- You have completed the following commissioning steps:
    - You have started to commission the safety functions.
    - You have selected the basic functions with control via onboard terminals of the inverter.
- The other selection options are described in the "Safety Integrated" function manual.

➔ Overview of the manuals (Page 507)

### 6.8.3.4 Configuring a safety function

#### Procedure with Startdrive



Proceed as follows to configure the safety functions:

1. Select "Select safety functionality".

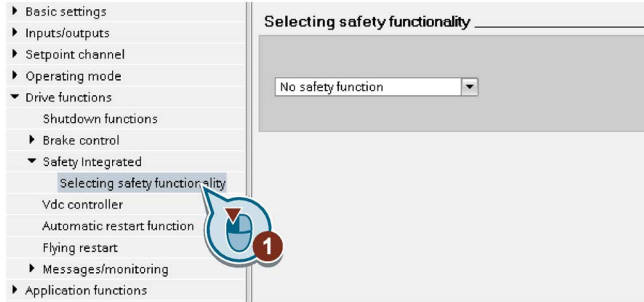

2. Enable the safety functions:

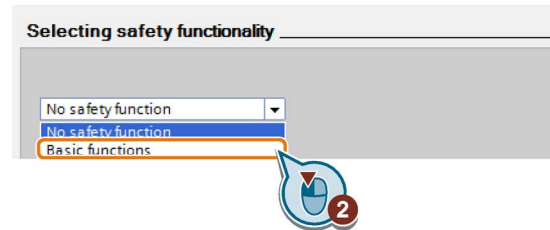

3. Select the control type of the safety functions:

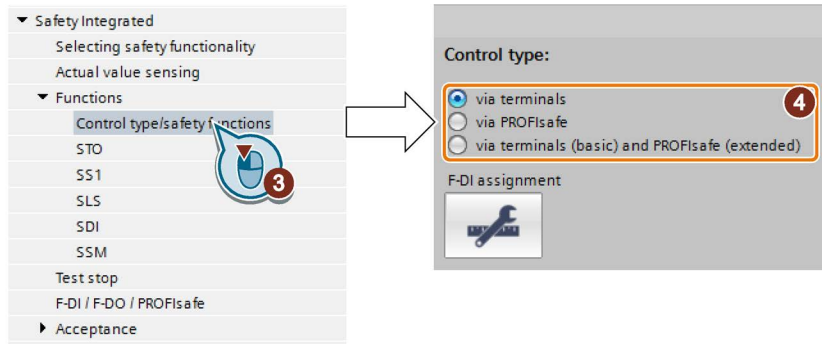

4. Define the interface for controlling the safety functions.



You have configured the safety functions



<b>Parameter</b>	<b>Description</b>
p0010 = 95	<b>Drive commissioning parameter filter</b> Safety Integrated commissioning
p9601	<b>Enable functions integrated in the drive</b> (factory setting: 0000 bin)
	Enabled functions:
	0 hex      None
	1 hex      Basic functions via onboard terminals
p9761	<b>Enter a password</b> (factory setting: 0000 hex) Permissible passwords lie in the range 1 ... FFFF FFFF.
p9762	<b>New password</b>
p9763	<b>Password confirmation</b>

6.8.3.5 Interconnecting the "STO active" signal

If you require the feedback signal "STO active" of the inverter in your higher-level control system, then you must appropriately interconnect the signal.

Precondition

You are online with STARTER or Startdrive.

Procedure with STARTER and Startdrive



To interconnect the "STO active" checkback signal, proceed as follows:

1. Select the button for the feedback signal.

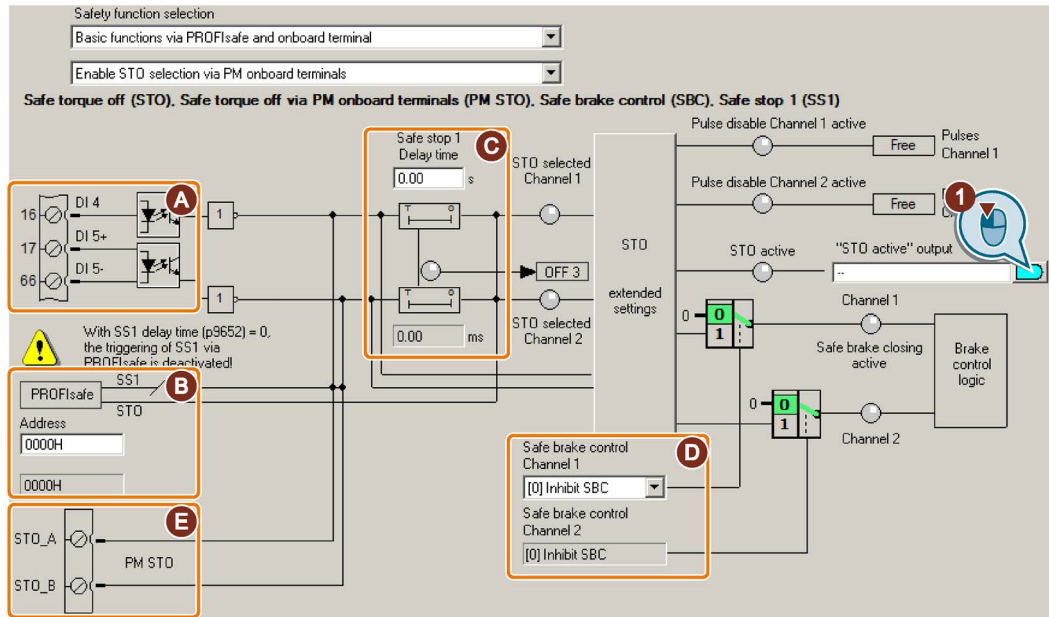

The screen form varies depending on the inverter and the interface that has been selected.

- (A) Input terminal or connector for SINAMICS inverters, F0 rail for SIMATIC ET 200pro FC-2.
- (B) PROFIsafe interface
- (C), (D) Delay time for SS1 and enable SBC for an inverter with CU250S-2 Control Unit
- (E) STO via the Power Module terminals for a PM240-2 FSD ... FSF

Image 6-62 Interconnecting "STO active" in STARTER

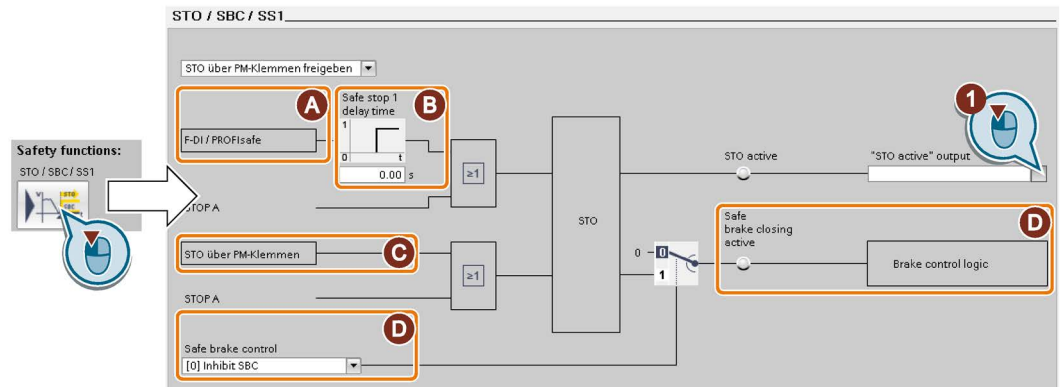

The screen form varies depending on the inverter and the interface that has been selected.

- (A) Control type
- (B) Delay time for SS1 and enable of SBC for an inverter with CU250S-2 Control Unit
- (C) STO via the Power Module terminals for a PM240-2 FSD ... FSF
- (D) Enable SBC for an inverter with CU250S-2 Control Unit

Image 6-63 Interconnecting "STO active" in Startdrive

2. Select the signal that matches your particular application.

- You have interconnected the "STO active" checkback signal. After STO has been selected, the inverter signals "STO active" to the higher-level control.

Parameter	Description
r9773.01	<b>1 signal:</b> STO is active in the drive

### 6.8.3.6 Setting the filter for safety-related inputs

#### Requirement

You are online with STARTER or Startdrive online.

#### Procedure with STARTER and Startdrive

➔ 1 To set the input filter and simultaneity monitoring of the safety-related input, proceed as follows:  
 2

1. Navigate to the filter settings.

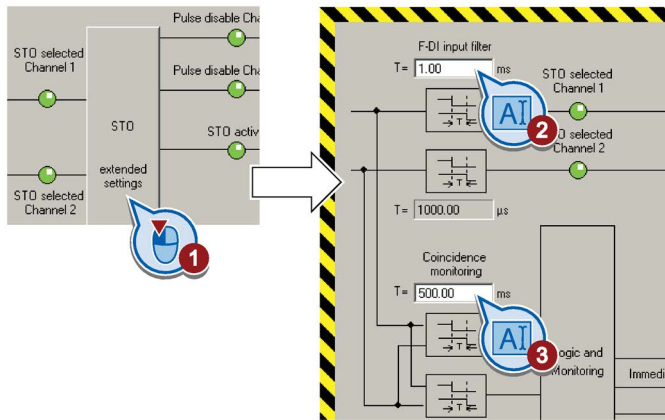

Image 6-64 Input filter and simultaneity monitoring in STARTER

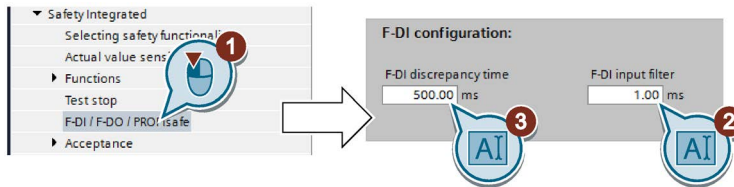

Image 6-65 Input filter and simultaneity monitoring in Startdrive

2. Set the debounce time for the F-DI input filter.
3. Set the discrepancy for the simultaneity monitoring.
4. Only applies to STARTER: Close the screen form.

■ You have set the input filter and the simultaneity monitoring of the safety-related input.

#### Description of the signal filter

The following are available for the signal processing of the safety-related inputs:

- A tolerance time for the simultaneity monitoring.
- A filter to suppress short signals, e.g. test pulses.

### Tolerance time for the simultaneity monitoring

The inverter checks whether the signals at both inputs always have the same signal status (high or low).

With electromechanical sensors (e.g. emergency stop buttons or door switches), the two sensor contacts never switch at exactly the same time and are therefore temporarily inconsistent (discrepancy). A long-term discrepancy indicates a fault in the wiring of a safety-related input, e.g. a wire break.

When appropriately set, the inverter tolerates brief discrepancies.

The tolerance time does not extend the inverter response time. The inverter selects its safety function as soon as one of the two F-DI signals changes its state from high to low.

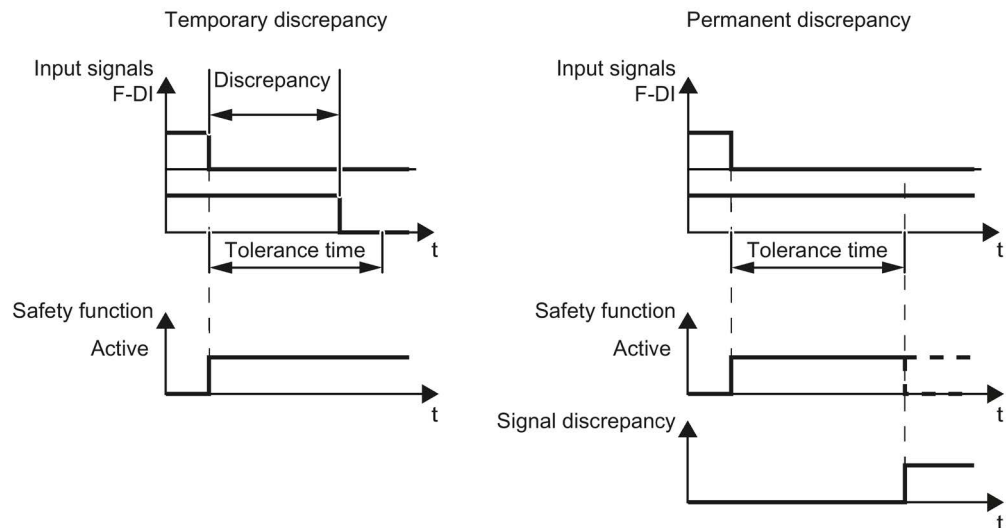

Image 6-66 Tolerance regarding discrepancy

### Filter to suppress short signals

The inverter normally responds immediately to signal changes at its safety-related inputs. This is not required in the following cases:

- When you interconnect a safety-related input of the inverter with an electromechanical sensor, contact bounce may result in signal changes occurring, to which the inverter responds.
- Several control modules test their safety-related outputs using bit pattern tests (light/darkness tests) to identify faults due to either short-circuiting or cross circuiting. When you interconnect a safety-related input of the inverter with a safety-related output of a control module, the inverter responds to these test signals. A signal change during a bit pattern test usually lasts:
  - On test: 1 ms
  - Off test: 4 ms

If the safety-related input signals too many signal changes within a certain time, then the inverter responds with a fault.

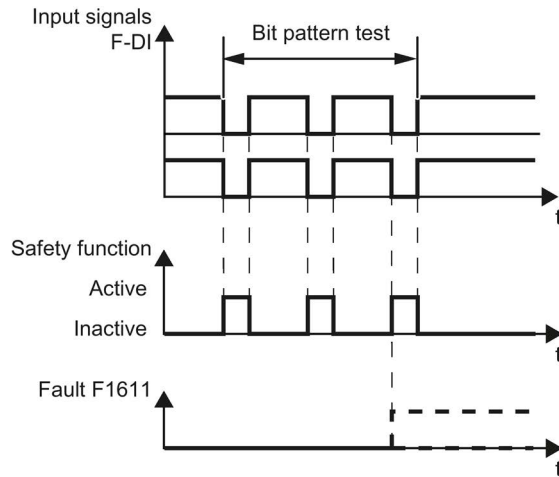

Image 6-67 Inverter response to a bit pattern test

An adjustable signal filter in the inverter suppresses temporary signal changes using bit pattern test or contact bounce.

The filter increases the inverter response time. The inverter only selects its safety function after the debounce time has elapsed.

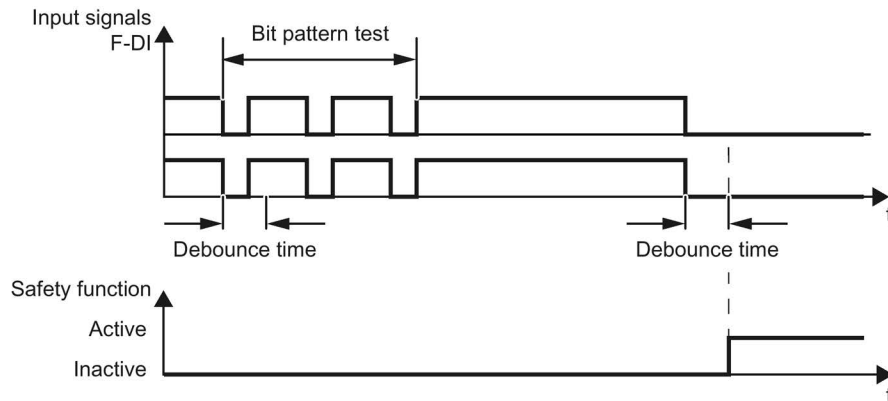

Image 6-68 Filter for suppressing temporary signal changes

Parameter	Description
p9650	<b>F-DI changeover tolerance time</b> (factory setting: 500 ms) Tolerance time to change over the fail-safe digital input for the basic functions.
p9651	<b>STO debounce time</b> (factory setting: 1 ms) Debounce time of the fail-safe digital input for the basic functions.

### Debounce times for standard and safety functions

The debounce time p0724 for "standard" digital inputs has no influence on the fail-safe input signals. Conversely, the same applies: The F-DI debounce time does not affect the signals of the "standard" inputs.

If you use an input as a standard input, set the debounce time using parameter p0724 .

If you use an input as a fail-safe input, set the debounce time as described above.

## 6.8.3.7 Setting the forced checking procedure (test stop)

### Requirement

You are online with STARTER or Startdrive online.

### Procedure with STARTER and Startdrive

- ➔ 1 To set the forced checking procedure (test stop) of the basic functions, proceed as follows:
1. Select the screen form for setting the forced checking procedure.

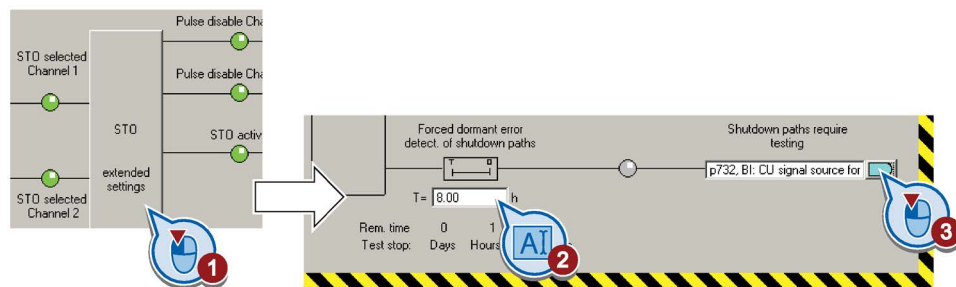

Image 6-69 Setting the forced checking procedure with STARTER

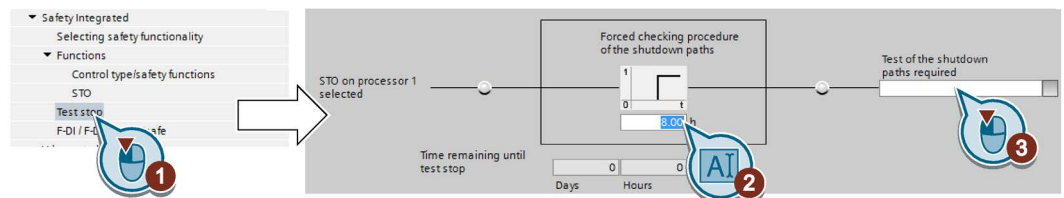

Image 6-70 Setting the forced checking procedure with Startdrive

2. Set the monitoring time to a value to match your application.
3. Using this signal, the inverter signals that a forced checking procedure (test stop) is required.

Interconnect this signal with an inverter signal of your choice.

4. Only applies to STARTER: Close the screen form.

■ You have set the forced checking procedure (test stop) for the basic functions.

**Description**

The forced checking procedure (test stop) of the basic functions is an inverter self test. The inverter checks its circuits to switch off the torque. If you are using the Safe Brake Relay, for a forced checking procedure, the inverter also checks the circuits of this component.

You start the forced checking procedure each time that the STO function is selected.

Using a timer block, the inverter monitors as to whether the forced checking procedure is regularly performed.

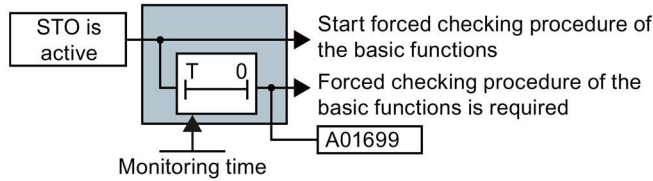

Image 6-71 Starting and monitoring the forced checking procedure (test stop)

Parameter	Description
p9659	<b>Forced dormant error detection timer</b> (Factory setting: 8 h) Monitoring time for the forced dormant error detection.
r9660	<b>Forced dormant error detection remaining time</b> Displays the remaining time until the forced dormant error detection and testing the safety switch-off signal paths.
r9773.31	<b>1 signal: Forced dormant error detection is required</b> Signals for the higher-level control system.



### 6.8.3.8 Activating the settings and checking the digital inputs

#### Activate settings

##### Requirement

You are online with STARTER or Startdrive online.

##### Procedure with STARTER



1 To activate the settings for the safety functions, proceed as follows:

1. Press the "Copy parameters" button, to create a redundant image of your inverter settings.

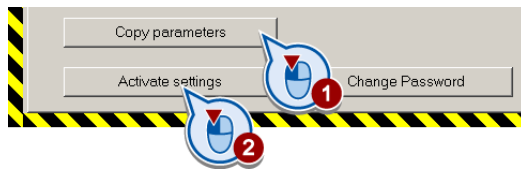

2. Press the "Activate settings" button.
3. If the password is the factory default, you are prompted to change the password.  
If you try to set a password that is not permissible, the old password will not be changed.
4. Confirm the prompt for saving your settings (copy RAM to ROM).
5. Switch off the inverter supply voltage.
6. Wait until all LEDs on the inverter go dark (no voltage condition).
7. Switch on the inverter supply voltage again.



Your settings are now active.

**Procedure with Startdrive**



To activate the settings of the safety functions in the drive, proceed as follows:

1. Click the "End safety commissioning" button.

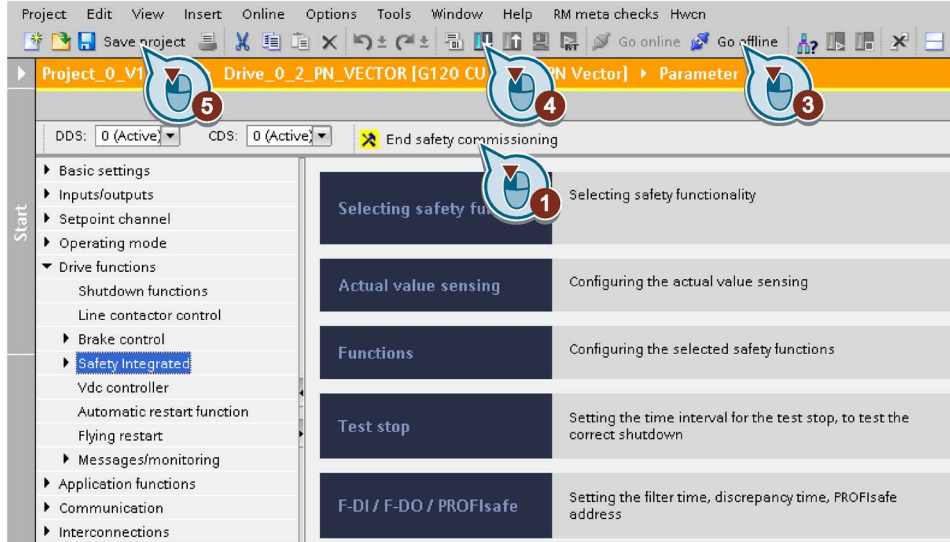

2. Confirm the prompt for saving your settings (copy RAM to ROM).
3. Disconnect the online connection.
4. Select the "Load from device (software)" button.
5. Save the project.
6. Switch off the inverter supply voltage.
7. Wait until all LEDs on the inverter go dark (no voltage condition).
8. Switch on the inverter supply voltage again.

■ Your settings are now active.

Parameter	Description
p9700 = D0 hex	<b>SI copy function</b> (factory setting: 0) Start the SI parameter copy function.
p9701 = DC hex	<b>Confirm data change</b> (factory setting: 0) Confirm SI Basic parameter change
p0010 = 0	<b>Drive commissioning parameter filter</b> 0: Ready
p0971 = 1	<b>Save parameter</b> 1: Save the drive object (copy from RAM to ROM) After the inverter has saved the parameters in a non-volatile fashion, then p0971 = 0.

## Checking the connection of digital inputs

The simultaneous connection of digital inputs with a safety function and a "standard" function may lead to the drive behaving in unexpected ways.

If you control the safety functions in the inverter using digital inputs, you must check whether these digital inputs are connected to a "standard" function.

### Procedure with STARTER



1 Proceed as follows to check as to whether the safety-related inputs are only used for the safety functions:

1. In the project navigator, select the inputs/outputs.
2. Select the screen for the digital inputs.
3. Remove all digital input interconnections that you use as safety-related input F-DI:

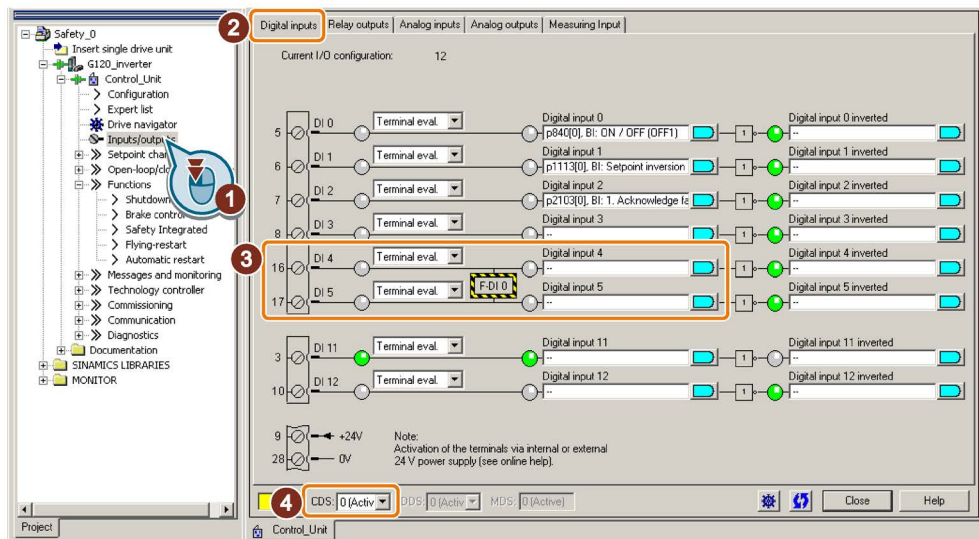

Image 6-72 Removing the DI 4 and DI 5 digital-input connections

4. You must delete the digital input connections for all CDS if you use the switchover of the command data sets (CDS).

You can find a description of the CDS switchover in the operating instructions.



You have ensured that the safety-related inputs only control safety functions in the inverter.

**Procedure with Startdrive**



1 Proceed as follows to check as to whether the safety-related inputs are only used for the safety functions:

- 2
- 1. Select the screen for the digital inputs.
- 2. Remove all digital input interconnections that you use as safety-related input F-DI:

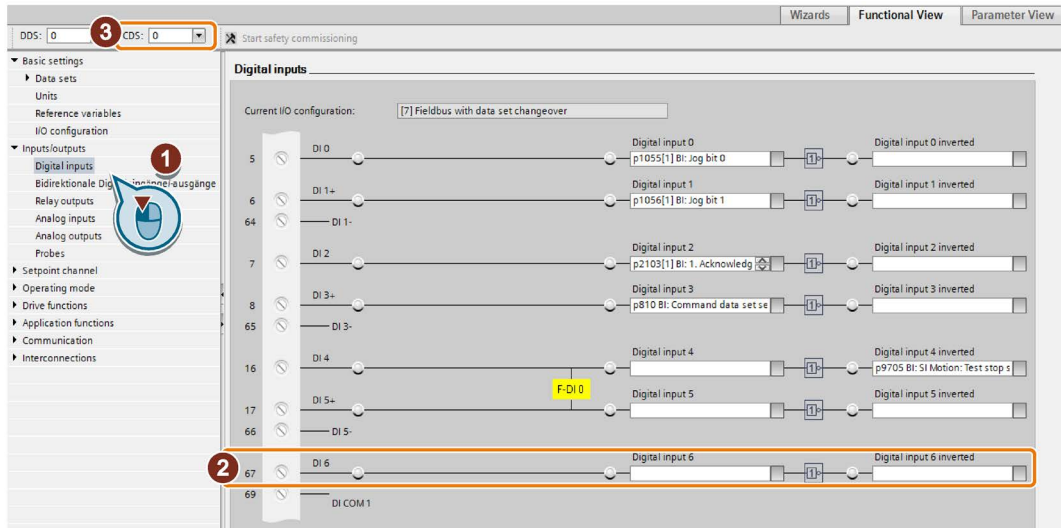

3. You must delete the digital input connections for all CDS if you use the switchover of the command data sets (CDS).

You can find a description of the CDS switchover in the operating instructions.



You have ensured that the safety-related inputs only control safety functions in the inverter.

### 6.8.3.9 Approval - completing commissioning

#### What is an acceptance?

The machine manufacturer is responsible in ensuring that his plant or machine functions perfectly. As a consequence, after commissioning, the machine manufacturer must check those functions or have them checked by specialist personnel, which represent an increased risk of injury or material damage. This acceptance or validation is, for example, also specified in the European machinery directive and essentially comprises two parts:

- Checking the safety-relevant functions and machine parts.  
→ **Acceptance test.**
- Generate an "Acceptance report" that describes the test results.  
→ **Documentation.**

Supply information for the validation, e.g. the harmonized European standards EN ISO 13849-1 and EN ISO 13849-2.

#### Acceptance test of the machine or plant

The acceptance test checks whether the safety-relevant functions in the plant or machine function correctly. The documentation of the components used in the safety functions can also provide information about the necessary tests.

Testing the safety-related functions includes, e.g. the following:

- Are all safety equipment such as protective door monitoring devices, light barriers or emergency-off switches connected and ready for operation?
- Does the higher-level control respond as expected to the safety-relevant feedback signals of the inverter?
- Do the inverter settings match the configured safety-relevant function in the machine?

#### Acceptance test of the inverter

The acceptance test of the inverter is a part of the acceptance test of the entire machine or plant.

The acceptance test of the inverter checks whether the integrated drive safety functions are set up correctly for the planned safety function of the machine.



Acceptance tests for the safety functions (Page 501)

**Documentation of the inverter**

The following must be documented for the inverter:

- The results of the acceptance test.
- The settings of the integrated drive safety functions.

The STARTER commissioning tool logs the settings of the integrated drive functions, if necessary.

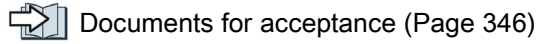

The documentation must be signed.

**Who may perform the acceptance test of the inverter?**

Personnel from the machine manufacturer, who, on account of their technical qualifications and knowledge of the safety functions, are in a position to perform the acceptance test in the correct manner are authorized to perform the acceptance testing of the inverter.

**Reduced acceptance test after function expansions**

A full acceptance test is necessary only after first commissioning. A reduced acceptance test is sufficient when safety functions are expanded.

Measure	Acceptance test	
	Acceptance test	Documentation
Functional expansion of the machine (additional drive).	Yes. Only check the safety functions of the new drive.	<ul style="list-style-type: none"> <li>• Supplement machine overview</li> <li>• Supplement inverter data</li> <li>• Add function table</li> <li>• Log the new checksums</li> <li>• Countersignature</li> </ul>
Transfer of inverter settings to other identical machines by means of series commissioning.	No. Only check the control of all of the safety functions.	<ul style="list-style-type: none"> <li>• Add machine description</li> <li>• Check checksums</li> <li>• Check firmware versions</li> </ul>

**Documents for acceptance**

The STARTER provides you with a number of documents to be regarded as a recommendation for the acceptance tests of the safety functions.

### Procedure



1 Proceed as follows to create the acceptance documentation for the drive using STARTER:

1. In STARTER, select "Create acceptance documentation":

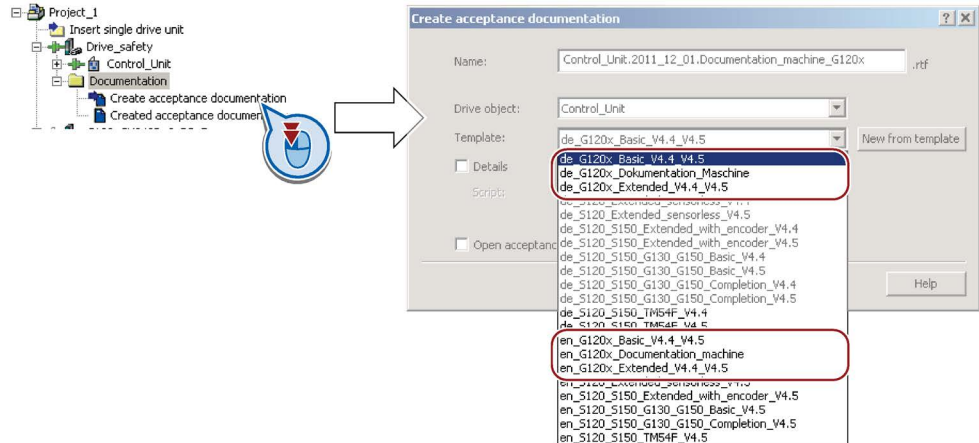

STARTER has templates in German and English.

2. Select the suitable template and create a report for each drive of your machine or system:

- Template for the machine documentation:
  - de\_G120x\_Dokumentation\_Maschine: German template.
  - en\_G120x\_Dokumentation\_machine: English template.
- Report of the settings for the basic functions, as of firmware version V4.4:
  - de\_G120x\_Basic\_V4.4...: German report.
  - en\_G120x\_Basic\_V4.4...: English report.

3. You load the created reports for archiving and the machine documentation for further processing:

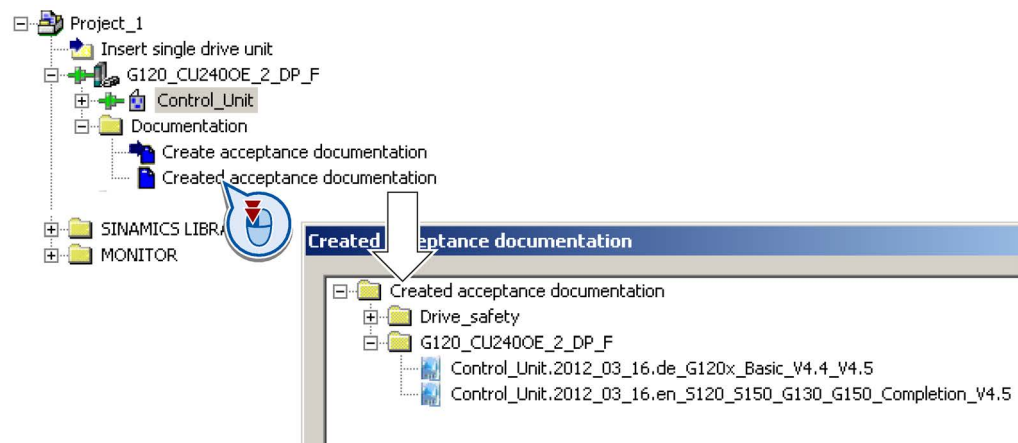

4. Archive the reports and the machine documentation.

■ You have generated the documents to accept the safety functions.

Acceptance tests for the safety functions (Page 501)

## 6.9 Switchover between different settings

There are applications that require different inverter settings.

**Example:**

You connect different motors to one inverter. Depending on the particular motor, the inverter must operate with the associated motor data and the appropriate ramp-function generator.

### Drive data sets (DDS)

You can set several inverter functions differently and then switch over between the different settings.

The associated parameters are indexed (index 0, 1, 2, or 3). Using control commands select one of the four indexes and therefore one of the four saved settings.

The settings in the inverter with the same index are called the drive data set.

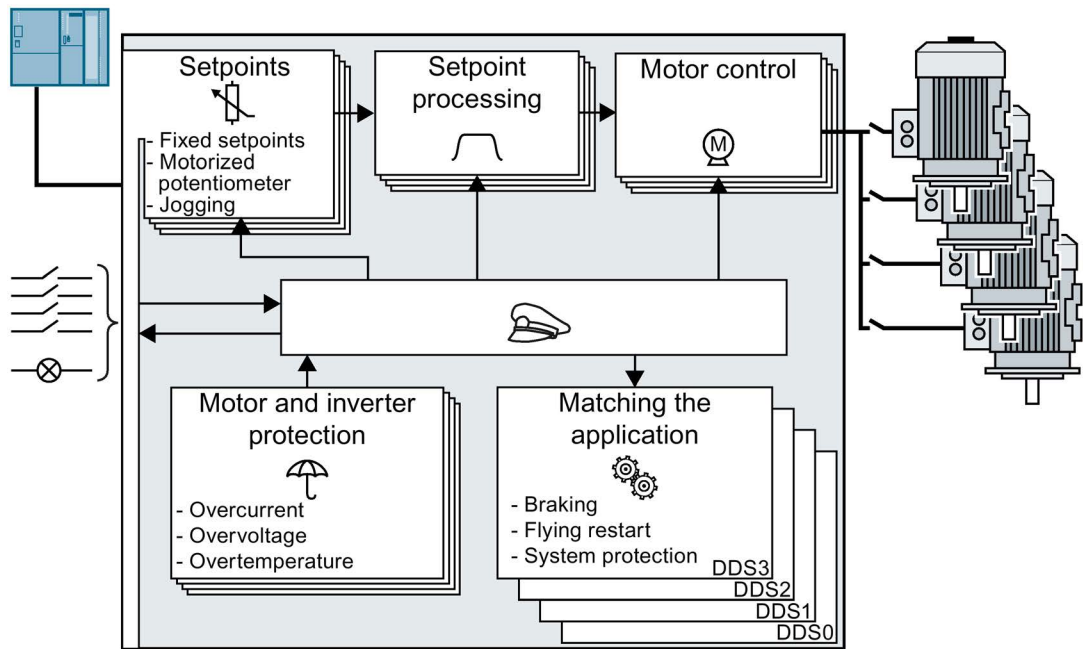

Image 6-73 Switching over between different settings using drive data sets (DDS)

Using parameter p0180 you can define the number of drive data sets (1 ... 4).

Table 6-48 Selecting the number of **drive data sets**

Parameter	Description
p0010 = 15	<b>Drive commissioning:</b> Data sets
p0180	<b>Drive data sets (DDS) number</b> (factory setting: 1)
p0010 = 0	<b>Drive commissioning:</b> Ready



Table 6- 49 Parameters for switching the drive data sets:

Parameter	Description	
p0820[0...n]	<b>Drive data set selection DDS bit 0</b>	If you use several command data sets CDS, then you must set this parameter for each CDS. The parameters are assigned to a CDS through their index: CDS0: p0820[0], p0821[0] CDS1: p0820[1], p0821[1] ...
p0821[0...n]	<b>Drive data set selection DDS bit 1</b>	
p0826	<b>Motor changeover, motor number</b> Each drive data set is assigned a motor number: p0826[0] = motor number for drive data set 0. ... p0826[3] = motor number for drive data set 3. If you operate the same motor with different drive data sets, then you must enter the same motor number in every index of parameter p0826. In this particular case, you can also switch over between the different drive data sets in operation. If you operate different motors on one inverter, then you must number the motors in parameter p0826. In this case, you may only switch over the drive data sets in the "ready for operation" state with the motor switched-off. The switchover time is approx. 50 ms.	
r0051	<b>Displaying the number of the DDS that is currently effective</b>	

For an overview of all the parameters that belong to the drive data sets and can be switched, see the List Manual.

Table 6- 50 Parameters for copying the drive data sets

Parameter	Description
p0819[0]	<b>Source drive data set</b>
p0819[1]	<b>Target drive data set</b>
p0819[2] = 1	<b>Start copy operation</b>

For more information, see the List Manual (the parameter list and function diagram 8565).



# Backing up data and series commissioning

## External data backup

After commissioning, your settings are saved in the inverter so that they are protected against power failure.

We recommend that you additionally back up the settings on a storage medium outside the inverter. Without backup, your settings could be lost if the inverter develops a defect.



Replacing the Control Unit without data backup (Page 386)

The following storage media are available for your settings:

- Memory card
- PG/PC
- Operator panel

---

### Note

#### Data backup using Operator Panels with USB connection with the PG/PC is not possible

If the inverter is connected to a PG/PC via a USB cable, you can save any data on the memory card using an Operator Panel.

- Before you save data to the memory card using an Operator Panel, disconnect the USB connection between the PG/PC and inverter.
- 

## Carrying out series commissioning

Series commissioning is the commissioning of several identical drives.

### Precondition

The Control Unit to which the settings are transferred has the same article number and the same or a higher firmware version as the source Control Unit.

### Overview

You must proceed as follows to carry out series commissioning:

1. Commission the first inverter.
2. Back up the settings of the first inverter to an external storage medium.
3. Transfer the settings of the first inverter to another inverter via the storage medium.

## 7.1 Backing up and transferring settings using a memory card

### What memory cards do we recommend?

 Overview of Control Units (Page 29)

### Using memory cards from other manufacturers

The inverter only supports memory cards up to 2 GB. SDHC cards (SD High Capacity) and SDXC cards (SD Extended Capacity) are not permitted.

If you use other SD or MMC memory cards, then you must format the memory card as follows:

- MMC: Format FAT 16
  - Insert the card into your PC's card reader.
  - Command to format the card:  
format x: /fs:fat (x: Drive code of the memory card on your PC)
- SD: Format FAT 16 or FAT 32
  - Insert the card into your PC's card reader.
  - Command to format the card:  
format x: /fs:fat or format x: /fs:fat32 (x: Drive code of the memory card on your PC.)

### Functional restrictions with memory cards from other manufacturers

The following functions are either not possible – or only with some restrictions – when using memory cards from other manufacturers:

- Licensing functions is only possible using the recommended memory cards.
- Know-how protection is only possible with one of the recommended memory cards.
- Under certain circumstances, memory cards from other manufacturers do not support writing or reading data from/to the inverter.

### 7.1.1 Saving setting on memory card

We recommend that you insert the memory card before switching on the inverter. The inverter always also backs up its settings on an inserted card.

If you wish to back up the inverter settings on a memory card, you have two options:

#### Automatically backing up

##### Preconditions

- The inverter power supply has been switched off.
- No USB cable is inserted in the inverter.

##### Procedure



Proceed as follows to automatically back up your settings:

1. Insert an empty memory card into the inverter.
2. Switch on the operating voltage of the inverter.

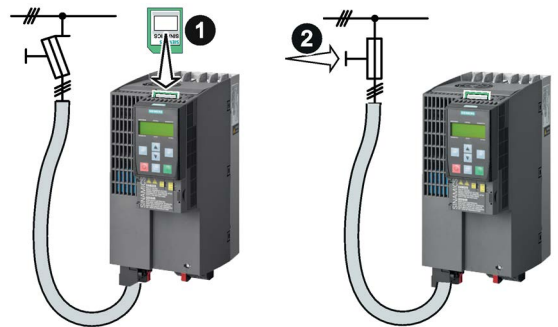

- After the power supply has been switched on, the inverter copies its changed settings to the memory card.

##### Note

If the memory card is not empty, then the inverter accepts the data from the memory card. This data then overwrites the data in the inverter.

- Only use empty memory cards when automatically backing up your settings for the first time.

### Manually backing up

#### Preconditions

- The inverter power supply has been switched on.
- No memory card is inserted in the inverter.

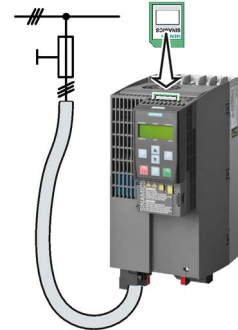

#### Procedure with STARTER

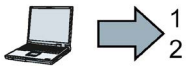

Proceed as follows to back up your settings on a memory card:

1. Go online.
2. Press the "Copy RAM to ROM" button .
3. In your drive, select "Drive Navigator".

A screenshot of the STARTER software interface. On the left, a tree view shows 'Control\_Unit' expanded to 'Drive navigator'. A blue callout bubble with the number '3' points to 'Drive navigator'. An arrow points from 'Drive navigator' to a 'Commissioning' button. A blue callout bubble with the number '4' points to the 'Commissioning' button. Another arrow points from the 'Commissioning' button to a button that looks like a memory card. A blue callout bubble with the number '5' points to this button. Below this is a large dialog box titled 'Back up data on memory card'. The dialog box shows a graphic of the inverter and a Siemens SINAMICS memory card. At the bottom, there are two input fields: 'Parameter set in the drive' with a dropdown menu showing '[0] Source/target standard', and 'Parameter set on memory card' with a text box containing '0'. A blue callout bubble with the number '6' points to the 'Parameter set on memory card' field.

4. Select the "Commissioning" button.
5. Select the button to transfer the settings to the memory card.

6. Select the settings as shown in the diagram and start the data backup.
7. Wait until STARTER signals that the data backup has been completed.
8. Close the screen forms.

■ You have backed up the settings of the inverter on the memory card.

### Procedure with Startdrive



Proceed as follows to back up the inverter settings to a memory card:

1. Go online.
2. Select "Online & diagnostics".

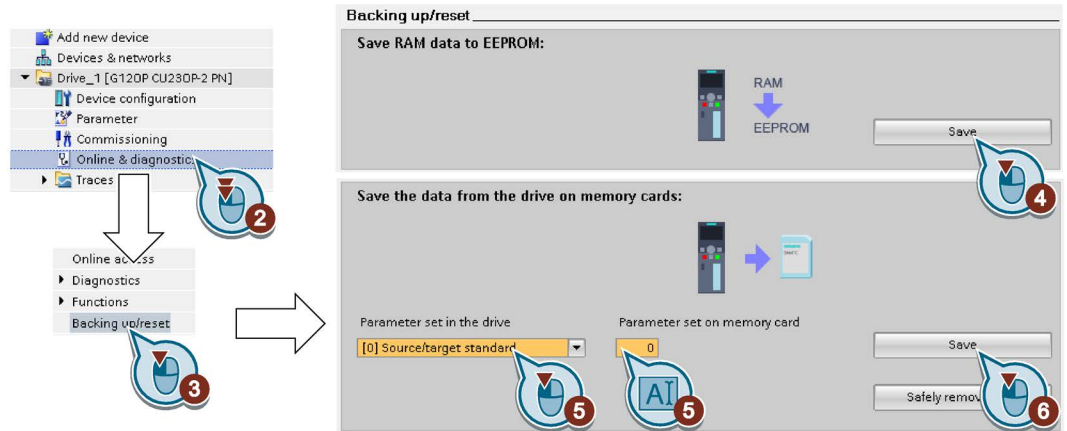

3. Select "Backing up/reset".
4. Back up the settings to the EEPROM of the inverter.
5. Select the settings as shown in the diagram.
6. Start data transfer
7. Wait until Startdrive has signaled that the data backup has been completed.

■ You have backed up the inverter settings to a memory card.

**Procedure with BOP-2**



Proceed as follows to back up your settings on a memory card:

1. If a USB cable is inserted in the inverter, withdraw it.
2. Go to the "OPTIONS" menu.
3. In the "OPTIONS" menu, select "TO CARD".
4. Set the number of your data backup. You can back up 99 different settings on the memory card.
5. Start data transfer with OK.
6. Wait until the inverter has backed up the settings to the memory card.

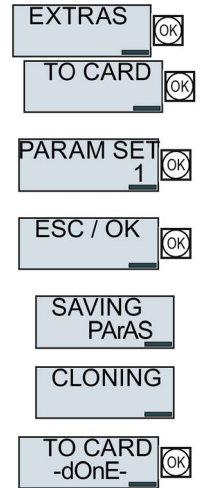

You have backed up the settings of the inverter on the memory card.



## 7.1.2 Transferring the setting from the memory card

### Automatically transferring

#### Precondition

The inverter power supply has been switched off.

#### Procedure



1 Proceed as follows to automatically transfer your settings:

1. Insert the memory card into the inverter.
2. Then switch on the inverter power supply.

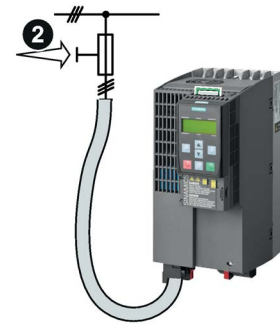

- If there is valid parameter data on the memory card, then the inverter accepts the data from the memory card.

### Manually transferring

#### Preconditions

- The inverter power supply has been switched on.
- No memory card is inserted in the inverter.

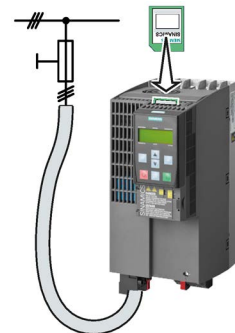

**Procedure with STARTER**

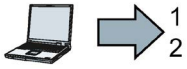

Proceed as follows to transfer settings from a memory card to the inverter:

1. Go online and in your drive, select the "Drive Navigator".
2. Select the "Commissioning" button.
3. Select the button to transfer the data from the memory card to the inverter.
4. Select the settings as shown in the diagram and start the data backup.

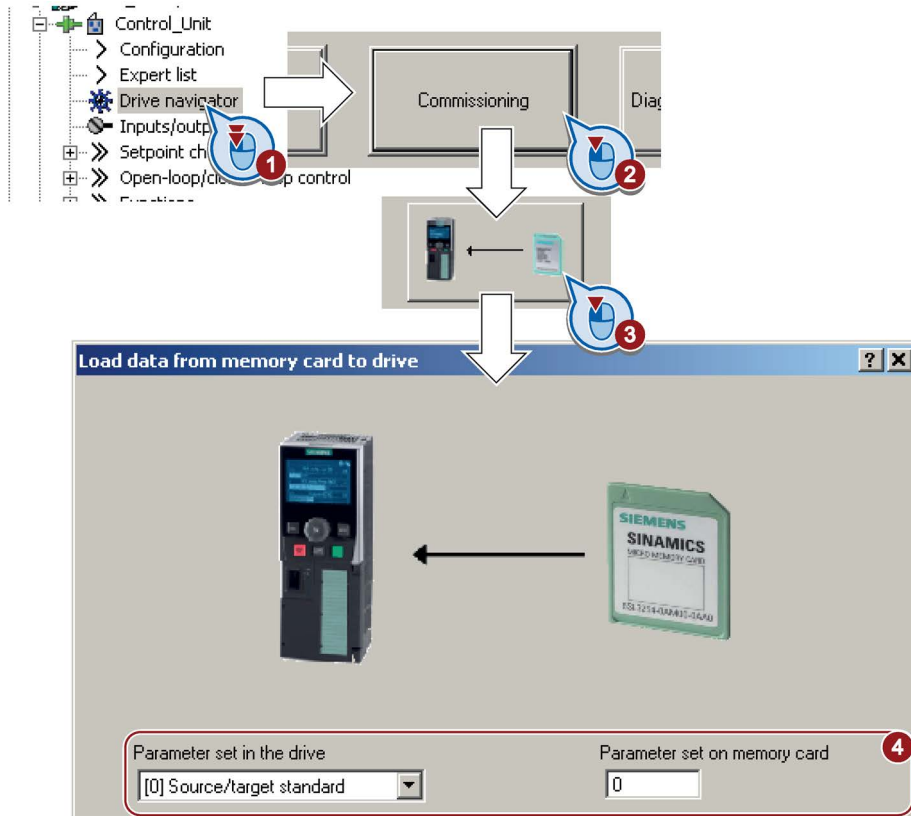

5. Wait until STARTER signals that the data backup has been completed.
6. Close the screen forms.
7. Go offline.
8. Switch off the inverter power supply.
9. Wait until all LEDs on the inverter are dark.
10. Switch on the inverter power supply again.

Your settings become effective after switching on.

■ You have now transferred your settings from a memory card to the inverter.

### Procedure with Startdrive

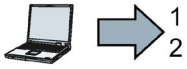

Proceed as follows to transfer settings from a memory card to the inverter:

1. Go online.
2. Select "Online & diagnostics".
3. Select "Backing up/reset".

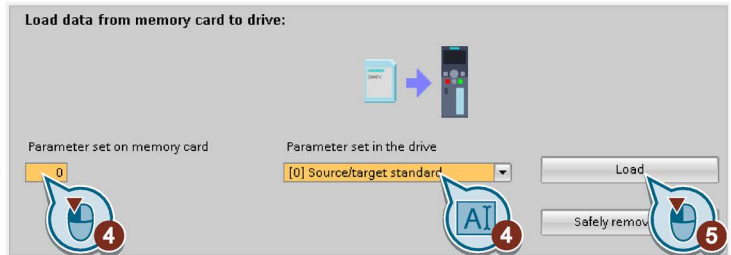
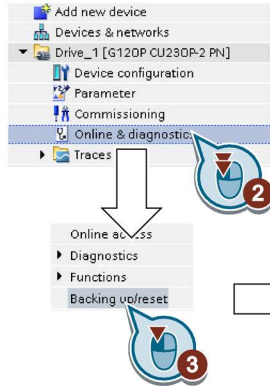

4. Select the settings as shown in the diagram.
5. Start data transfer
6. Wait until Startdrive has signaled that the data transfer has been completed.
7. Go offline.
8. Switch off the inverter power supply.
9. Wait until all LEDs on the inverter are dark.
10. Switch on the inverter power supply again.

Your settings become effective after switching on.

- You have now transferred your settings from a memory card to the inverter.

**Procedure with the BOP-2**



Proceed as follows to transfer the settings from a memory card to the inverter

1. If a USB cable is inserted in the inverter, withdraw it.
2. Go to the menu level "OPTIONS".
3. In the "OPTIONS" menu, select "FROM CRD".
4. Set the number of your data backup. You can back up 99 different settings on the memory card.
5. Start data transfer with OK.
6. Wait until the inverter has transferred the settings from the memory card.
7. Switch off the inverter power supply.
8. Wait until all LEDs on the inverter are dark.
9. Switch on the inverter power supply again.

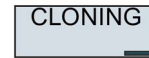
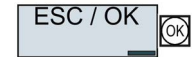
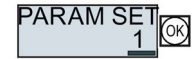
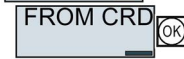

You have transferred the settings from the memory card to the inverter.

### 7.1.3 Safely remove the memory card

#### NOTICE

##### Data loss from improper handling of the memory card

If you remove the memory card when the converter is switched on without implementing the "safe removal" function you may destroy the file system on the memory card. The data on the memory card are lost. The memory card will only function again after formatting.

- Only remove the memory card using the "safe removal" function.

#### Procedure with STARTER



To safely remove the memory card, proceed as follows:

1. Go online.
2. In the Drive Navigator select the following screen form:

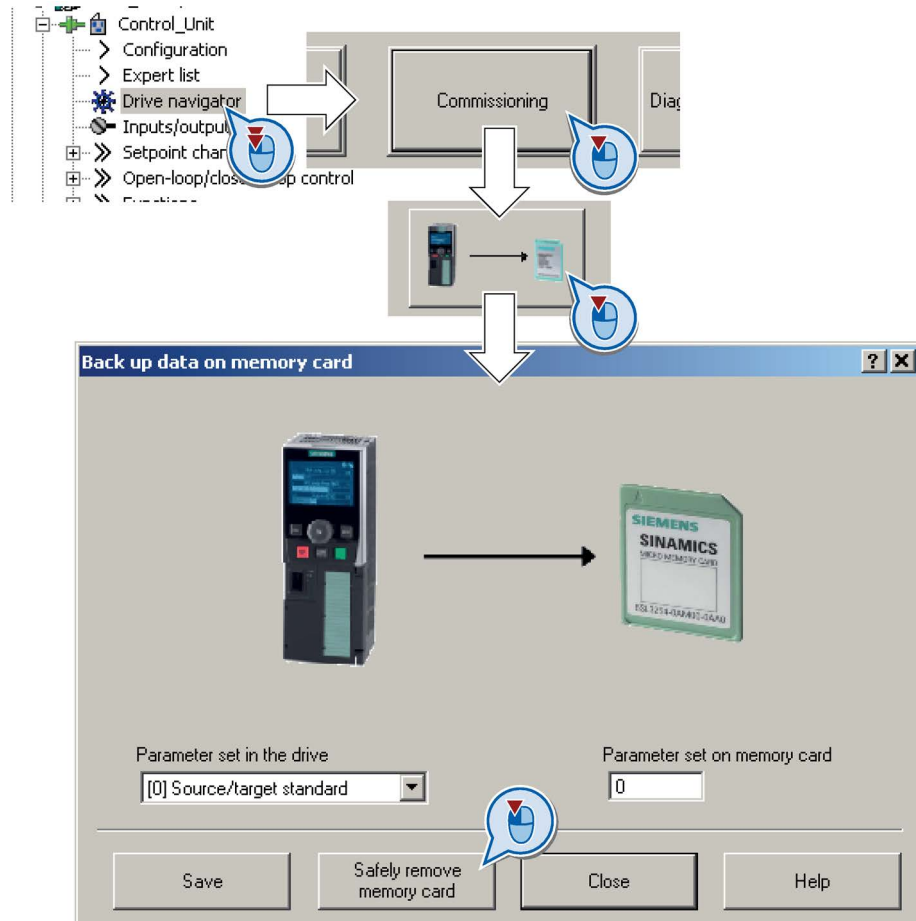

3. Click on the button to safely remove the memory card.

STARTER will tell you whether you can remove the memory card from the inverter.

- You have now safely removed the memory card from the inverter.

**Procedure with Startdrive**

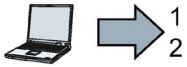

To safely remove the memory card, proceed as follows:

1. In the Drive Navigator select the following screen form:

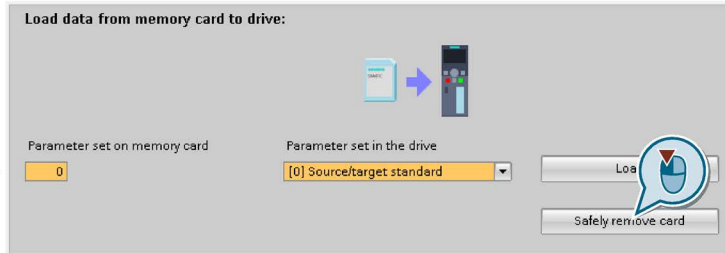
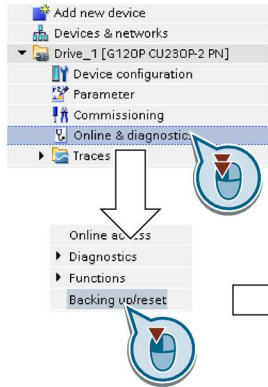

2. Click on the button to safely remove the memory card.

Startdrive will tell you whether you can remove the memory card from the inverter.

- You have now safely removed the memory card from the inverter.

**Procedure with the BOP-2**



To safely remove the memory card using BOP-2, proceed as follows:

1. Go to parameter p9400. If a memory card is correctly inserted, then p9400 = 1.
2. Set p9400 = 2.
3. The inverter sets p9400 = 3 or p9400 = 100.
  - p9400 = 3: You may remove the memory card from the inverter.
  - p9400 = 100: It is not permissible that you remove the memory card. Wait for several seconds and then set p9400 = 2 again.
4. Remove the memory card. After removing the memory card, p9400 = 0.

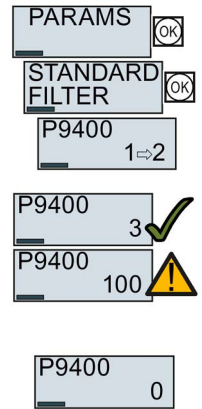

- You have now safely removed the memory card using BOP-2.

## 7.2 Saving settings on a PC

You can transfer the inverter settings to a PG/PC, or vice versa, the data from a PG/PC to the inverter.

### Requirements



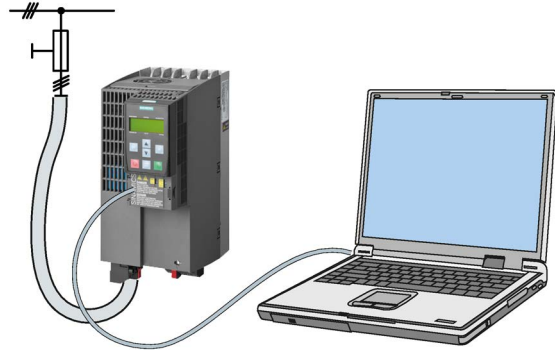

- The inverter power supply has been switched on.
- You have installed one of the commissioning tools STARTER or Startdrive to your PG/PC.

 Tools to commission the inverter (Page 51)



### Inverter → PC/PG

#### Procedure with STARTER

-  1 To back up the settings with STARTER, proceed as follows:
- 2
1. Go online: .
  2. Click the "Download project to PG" button: .
  3. Save the project: .
  4. Wait until STARTER reports that data backup has been completed.
  5. Go offline: .
- You have backed up the settings with STARTER.

#### Procedure with Startdrive

-  1 To back up the settings with Startdrive, proceed as follows:
- 2
1. Go online.
  2. Select "Online" > "Upload device to PG/PC."
  3. Back up the project with "Project" > "Save."
  4. Wait until Startdrive reports that data backup has been completed.
  5. Go offline.
- You have backed up the settings with Startdrive.





### PC/PG → inverter

The procedure depends on whether you also transfer settings of safety functions or not.

#### Procedure with STARTER without enabled safety functions



To load the settings from the PG to the inverter with STARTER, proceed as follows:

1. Go online: .
2. Click the "Download project to target system" button: .
3. Wait until STARTER reports that loading has been completed.
4. To save the data to the non-volatile memory of the inverter, select the "Copy RAM to ROM" button: .
5. Go offline: .



You have transferred the settings from the PG to the inverter with STARTER.

#### Procedure with Startdrive without enabled safety functions



To transfer the settings from the PG to the inverter with Startdrive, proceed as follows:

1. Go online.
2. Select "Load to device" > "Hardware and software" from the shortcut menu.
3. Wait until Startdrive reports that loading has been completed.
4. Go offline.
5. Confirm the dialog box that then opens by clicking "Yes" to save the data to the non-volatile memory of the inverter (Copy from RAM to ROM).





You have transferred the settings from the PG to the inverter with Startdrive.



**Procedure with STARTER with enabled safety functions**

➔ 1 To load the settings from the PG to the inverter with STARTER and to activate the safety functions, proceed as follows:

- 2
1. Go online: .
2. Click the "Download project to target system" button: .
3. Call the STARTER screen form for the safety functions.

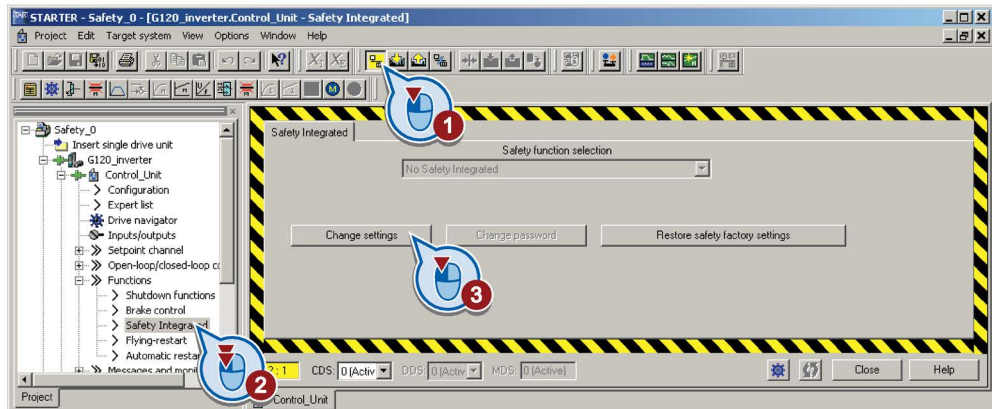



You have transferred the settings from the PG to the inverter.

To activate the safety functions, proceed as follows:

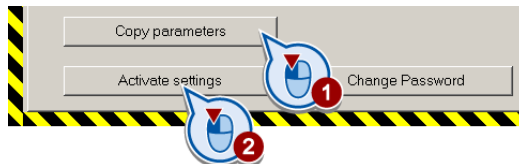
1. Select the "Copy parameter" button.
2. Press the "Activate settings" button.



3. To save the data in the inverter, click the "Copy RAM to ROM" button: .
4. Go offline: .
5. Switch off the inverter power supply.
6. Wait until all LEDs on the inverter go off.
7. Switch on the inverter power supply again. Your settings only become effective after this power-on reset.

■ You have transferred the settings from the PG to the inverter with STARTER and activated the safety functions.

Procedure with Startdrive



To transfer the settings from the PG to the inverter with Startdrive and activate the safety functions, proceed as follows:

- 1. Save the project.
- 2. Select "Load to device."

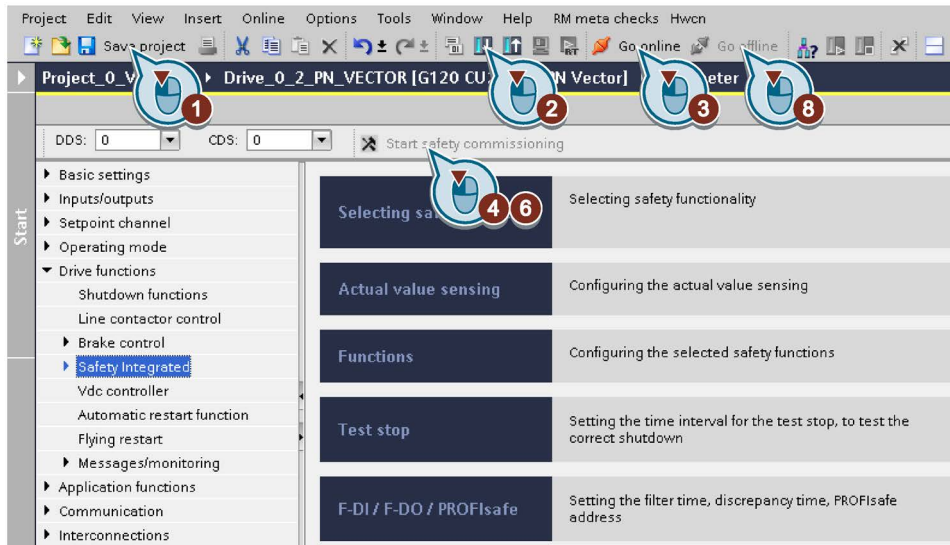

Image 7-1 Activating settings in Startdrive

- 3. Connect Startdrive online with the drive.
- 4. Click the "Start safety commissioning" button.
- 5. Enter the password for the safety functions.  
If the password is the factory default, you are prompted to change the password.  
If you try to set a password that is not permissible, the old password will not be changed.
- 6. Click the "End safety commissioning" button.
- 7. Confirm the prompt for saving your settings (copy RAM to ROM).
- 8. Disconnect the online connection.
- 9. Switch off the inverter supply voltage.
- 10. Wait until all LEDs on the inverter go dark (no voltage condition).
- 11. Switch on the inverter supply voltage again.



You have transferred the settings from the PG to the inverter with Startdrive and have activated the safety functions.

## 7.3 Saving settings and transferring them using an operator panel

You can transfer the inverter settings to the Operator Panel BOP-2 or vice versa, the data from the BOP-2 to the inverter.

### Precondition

The inverter power supply has been switched on.

### Inverter → BOP-2

#### Procedure



To back up the settings on the BOP-2, proceed as follows:

1. Go to the menu level "OPTIONS".
2. In the "OPTIONS" menu, select "TO BOP".
3. Start data transfer with OK.
4. Wait until the inverter has backed up the settings to the BOP-2.

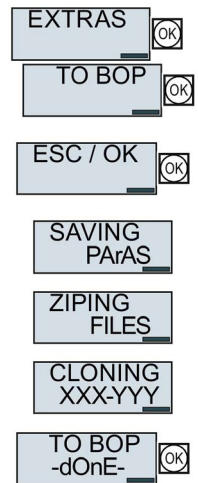

- You have backed up the settings on the BOP-2.

### BOP-2 → inverter

#### Procedure



To transfer the settings to the inverter, proceed as follows:

1. Go to the menu level "OPTIONS".
2. In the "OPTIONS" menu, select "FROM BOP".
3. Start data transfer with OK.
4. Wait until the inverter has written the settings to the memory card.

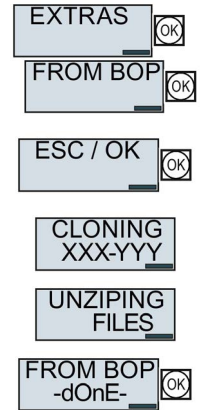

5. Switch off the inverter power supply.
6. Wait until all LEDs on the inverter are dark.
7. Switch on the inverter power supply again.  
Your settings become effective after switching on.

■ You have transferred the settings to the inverter.

## 7.4 Other ways to back up settings

In addition to the default setting, the inverter has an internal memory for backing up three other settings.

On the memory card, you can back up 99 other settings in addition to the default setting.



Additional information is available in the Internet: Memory options (<http://support.automation.siemens.com/WW/view/en/43512514>).

## 7.5 Write and know-how protection

The inverter offers the option to protect configured settings from being changed or copied.

Write protection and know-how protection are available for this purpose.

### 7.5.1 Write protection

Write protection prevents inadvertently changing inverter settings. If you are working with a PC tool, such as STARTER, then write protection is only effective online. The offline project is not write-protected.

Write protection is applicable for all user interfaces:

- BOP-2 and IOP operator panels
- STARTER or Startdrive PC tool
- Parameter changes via a fieldbus

The write protection is not password-protected.

### Activate and deactivate write protection

#### Procedure with STARTER



Proceed as follows to activate or deactivate the write protection:

1. Go online.
2. Open the inverter shortcut menu.
3. Activate or deactivate write protection.
4. Press the “Copy RAM to ROM” button to retentively save the settings .

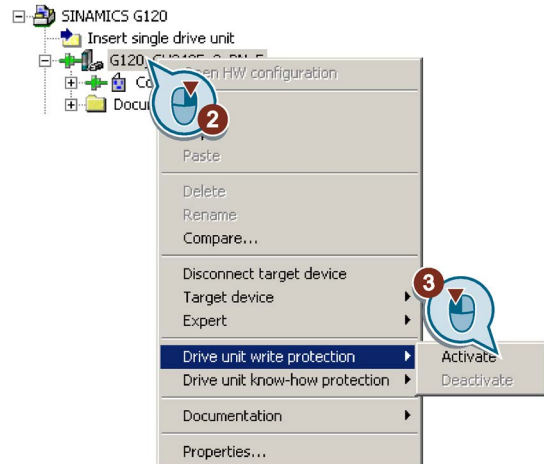

You have activated or deactivated write protection.

Parameters		
r7760	<b>Write protection/know-how protection status</b>	
	.00	Write protection active
p7761	<b>Write protection</b> (factory setting: 0)	
	0:	Deactivate write protection
	1:	Activate write protection

## **Exceptions to write protection**

Some functions are excluded from write protection, e.g.:

- Activating/deactivating write protection
- Changing the access level (p0003)
- Saving parameters (p0971)
- Safely removing the memory card (p9400)
- Restoring the factory setting
- Importing settings from an external data backup, e.g. upload from a memory card to the converter.

The individual parameters that are excluded from the write protection, can be found in the List Manual in Chapter "Parameters for write protection and protection of know-how".

---

### **Note**

#### **Write protection for multimaster fieldbus systems**

When using multimaster fieldbus systems (e.g. CAN Bus, BACnet), parameters can be changed in spite of an active write protection. So that write protection is also active when accessing via these fieldbuses, you must additionally set p7762 to 1.

In STARTER, this setting is only possible via the expert list.

---

## 7.5.2 Know-how protection

### Know-how protection

The know-how protection is used to encrypt configuring/engineering know-how, and protect it against being changed or copied.

The settings of the inverter are protected by a password.

If the password is lost, only default settings are possible.

The active know-how protection provides the following:

- All setting parameters are invisible.
- Parameters cannot be changed with a commissioning tool, e.g. Operator Panel or STARTER.
- It is not possible to download the inverter settings with the Starter or via a memory card
- It is not possible to use the trace function in the STARTER.
- Deleting the alarm history
- The STARTER dialog screens are disabled. The expert list in the STARTER contains only display parameters.

In the case of active know-how protection, support by technical support personnel is only possible with the consent of the machine manufacturer.

### Copy protection

In conjunction with the copy protection, the inverter settings can be coupled only to a single, pre-defined hardware.

Know-how protection with copy protection is possible only using the recommended Siemens card.



Overview of Control Units (Page 29)

### List of exceptions

The active know-how protection permits an exception list for parameters to be defined that the customer may access.

If you remove the parameter for the password from the exception list, the know-how protection can only be undone by reverting to the factory settings.





### Actions that are possible during active know-how protection

- Restore factory settings
- Acknowledge messages
- Display messages
- Show message history
- Read out diagnostic buffer
- Switching to the control panel (complete control panel functionality: Fetch master control, all buttons and setting parameters)
- Upload (only parameters that are accessible even though know-how protection is active)

The individual parameters that are excluded from the know-how protection can be found in the List Manual in Chapter "Parameters for write protection and protection of know-how".

### Commissioning the inverter with know-how protection

#### Procedure - overview

1. Commission the inverter.
2. Create the exception list.  
 List of exceptions (Page 376)
3. Activate the know-how protection.  
 Know-how protection (Page 373)
4. Save the settings in the inverter by copying RAM to ROM.
5. Save the project on the computer/PG. Also back up any other project-related data (machine type, password, etc.) that may be required for the support of the end customer.

#### 7.5.2.1 Settings for know-how protection

### Activating know-how protection

#### Preconditions

- You are online.  
If you have created a project offline on your computer, you must download it to the inverter and go online.
- You have inserted the recommended Siemens card.

 Overview of Control Units (Page 29)

**Procedure**



Proceed as follows to activate know-how protection:

1. Select the inverter in the STARTER project and select "Know-how protection drive device / Activate ..." in the shortcut menu.

 Write protection (Page 370)

2. Enter your password. Length of the password: 1 ... 30 characters.

For the password, we recommend that you only use characters from the ASCII character set. If you use any character for the password, then if changes are made to the Windows language settings after activating know-how protection, errors can occur when subsequently checking the password.

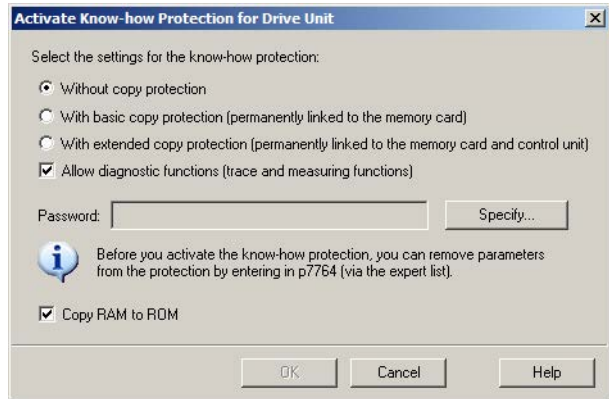

3. In this screen form, press the "Copy RAM to ROM" button. This means that you save your settings so that they are protected against power failure.

You have activated know-how protection.

**Backing up settings on the memory card**

When know-how protection is activated, you can save the settings to the memory card using p0971.

To do this, set p0971 = 1. The data is written to the memory card encrypted. After saving, p0971 is reset to 0.

**Deactivating know-how protection, deleting a password**

**Preconditions**

- You are online with STARTER.
- You have inserted the recommended Siemens card.

 Overview of Control Units (Page 29)

**Procedure**

1 Proceed as follows to deactivate know-how protection:

1. Select the inverter in the STARTER project, and using the right-hand mouse button, open the dialog window "Know-how protection drive device/deactivate ...".

2. There, select the desired option.

- Temporary status: Know-how protection is active again after switching the power supply off and on.

- Final status: If you select "Copy RAM to ROM", the inverter immediately deletes the password. If you do not select "Copy RAM to ROM", the inverter deletes the password the next time the power supply is switched off.

3. Enter the password and exit the screen form with OK.



You have deactivated know-how protection.

**Changing the password**

Select the inverter in the STARTER project, and open the dialog screen form using the shortcut menu "Know-how protection drive device/change password ...".



### 7.5.2.2 Generating an exception list for know-how protection

Using the exception list, as machine manufacturer you can make individual adjustable parameters accessible to end users although know-how protection is active. You may define the exception list via parameters p7763 and p7764 in the expert list. Specify the number of parameters for the selection list in p7763. Assign the individual indexes to the parameter numbers of the selection list in p7764.

#### Procedure



Proceed as follows to change the number of parameters for the selection list:

1. Save the inverter settings via an upload () on the PC/PG and go offline ()
2. In the project on the PC, set p7763 to the desired value.
3. Save the project.
4. Go online and load the project into the inverter ()
5. Now make the additional settings in p7764.

■ You have modified the number of parameters for the selection list.

Factory setting for the exception list:

- p7763 = 1 (selection list contains precisely one parameter)
- p7764[0] = 7766 (parameter number for entering the password)

---

#### Note

##### Block access to the inverter as a result of incomplete exception lists

If you remove p7766 from the exception list, you can no longer enter a password and therefore no longer deactivate know-how protection.

In this case to access the inverter again, you have to reset the inverter to the factory settings.

---

## Corrective maintenance

### 8.1 Replacing inverter components

#### 8.1.1 Overview of replacing converter components

##### Permissible replacement of components

In the event of a long-term function fault, you must replace the Power Module or Control Unit. The inverter's Power Module and Control Unit can be replaced independently of each other.

In the following cases you will need to replace the inverter:

Replacing the Power Module		Replacing the Control Unit	
<b>Replacement:</b> <ul style="list-style-type: none"> <li>Same type</li> <li>Same power rating</li> </ul>	<b>Replacement:</b> <ul style="list-style-type: none"> <li>Same type</li> <li>Same frame size</li> <li>Higher power rating</li> </ul>	<b>Replacement:</b> <ul style="list-style-type: none"> <li>Same type</li> <li>Same firmware version</li> </ul>	<b>Replacement:</b> <ul style="list-style-type: none"> <li>Same type</li> <li>Higher firmware version (e.g. replace FW V4.2 by FW V4.3)</li> </ul>
	Power Module and motor must be adapted to one another (ratio of motor and Power Module rated power > 1/8)	After replacing the Control Unit, you must restore the inverter's settings.	

#### **WARNING**

##### **Risk of injury due to uncontrolled drive motion**

Replacing inverters of different types can result in uncontrolled motion of the drive.

- In all cases that are not permitted according to the table above, recommission the drive after replacing an inverter.

### Special issue relating to communication via PROFINET: Device replacement without removable data storage medium

The inverter supports the PROFINET functionality, replacing the device without data storage medium. After replacing the Control Unit, the inverter is automatically assigned its device name from the IO controller.

Independent of this, after replacing the inverter, you must transfer the settings of the old inverter to the new inverter.

Details of the device replacement without removable storage medium can be found in the Internet:



PROFINET system description  
(<http://support.automation.siemens.com/WW/view/en/19292127>).

## 8.1.2 Replacing a Control Unit with enabled safety function

### Replacing a Control Unit with data backup on a memory card

If you use a memory card with firmware, after the replacement, you obtain a precise copy (firmware and settings) of the replaced Control Unit.

#### Precondition

You have a memory card with the actual settings of the Control unit to be replaced.

#### Procedure



To replace the Control Unit, proceed as follows:

1. Disconnect the line voltage to the Power Module and (if installed) the external 24 V supply or the voltage for the digital outputs of the Control Unit.
2. Remove the signal cables from the Control Unit.
3. Remove the defective Control Unit.
4. Remove the memory card from the old Control Unit and insert it in the new Control Unit.
5. Mount the new Control Unit on the Power Module. The new Control Unit must have the same article number and the same or higher firmware version as the Control Unit that was replaced.
6. Reconnect the signal cables of the Control Unit.
7. Switch on the line voltage again.
8. The inverter loads the settings from the memory card.
9. Check what the inverter reports after loading.
  - Alarm A01028:  
The loaded settings are not compatible with the inverter.  
Clear the alarm with p0971 = 1 and recommission the drive.
  - Fault F01641:  
Acknowledge the message.  
Perform a **reduced** acceptance test.



Reduced acceptance after component replacement and firmware change  
(Page 397)

- You have replaced the Control Unit and transferred the safety function settings from the memory card to the new Control Unit.

## Replacing a Control Unit with data backup in STARTER

### Precondition

You have backed up the actual settings of the Control Unit to be replaced to a PC using STARTER.

### Procedure



To replace the Control Unit, proceed as follows:

1. Disconnect the line voltage to the Power Module and (if installed) the external 24 V supply or the voltage for the digital outputs of the Control Unit.
2. Remove the signal cables of the Control Unit.
3. Remove the defective Control Unit.
4. Mount the new Control Unit on the Power Module.
5. Reconnect the signal cables of the Control Unit.
6. Switch on the line voltage again.
7. Open the project in the PC the matches the drive.
8. Go online and transfer the settings from the PC to the inverter by pressing the  button. The inverter signals faults after the download. Ignore these faults, as they will be automatically acknowledged by the following steps.
9. Select the screen form for the safety functions.
10. Select the "Change settings" button.
11. Select the "Activate settings" button.
12. Save your settings (copy RAM to ROM).
13. Switch off the inverter power supply.
14. Wait until all LEDs on the inverter go dark.
15. Switch on the inverter power supply again.
16. Perform a **reduced** acceptance test.



Reduced acceptance after component replacement and firmware change  
(Page 397)



You have replaced the Control Unit and transferred the safety function settings from the PC to the new Control Unit.



## Replacing a Control Unit with data backup in Startdrive

### Precondition

You have backed up the actual settings of the Control Unit to be replaced to a PC using Startdrive.

### Procedure



To replace the Control Unit, proceed as follows:

1. Disconnect the line voltage to the Power Module and (if installed) the external 24 V supply or the voltage for the digital outputs of the Control Unit.
2. Remove the signal cables of the Control Unit.
3. Remove the defective Control Unit.
4. Mount the new Control Unit on the Power Module.
5. Reconnect the signal cables of the Control Unit.
6. Switch on the line voltage again.
7. Open the project in the PC that matches the drive.
8. Select "Load to device".
9. Connect Startdrive online with the drive.

The inverter signals faults after the download. Ignore these faults, as they will be automatically acknowledged by the following steps.

10. Press the "Start safety commissioning" button.
11. Enter the password for the safety functions.
12. Confirm the prompt for saving your settings (copy RAM to ROM).
13. Disconnect the online connection.
14. Switch off the inverter power supply.
15. Wait until all LEDs on the inverter go dark.
16. Switch on the inverter power supply again.
17. Perform a **reduced** acceptance test.



Reduced acceptance after component replacement and firmware change  
(Page 397)

- You have replaced the Control Unit and transferred the safety function settings from the PC to the new Control Unit.

## Replacing the Control Unit with data backup in the operator Panel

### Precondition

You have backed up the actual settings of the Control Unit to be replaced to an Operator Panel.

### Procedure



To replace the Control Unit, proceed as follows:

1. Disconnect the line voltage to the Power Module and (if installed) the external 24 V supply or the voltage for the digital outputs of the Control Unit.
2. Remove the signal cables of the Control Unit.
3. Remove the defective Control Unit.
4. Mount the new Control Unit on the Power Module.
5. Reconnect the signal cables of the Control Unit.
6. Switch on the line voltage again.
7. Plug the Operator Panel into the Control Unit or connect the Operator Panel handheld device with the inverter.
8. Transfer the settings from the Operator Panel to the inverter.
9. Wait until the transfer is complete.
10. After loading, check whether the inverter outputs alarm A01028.
  - Alarm A01028:  
The loaded settings are not compatible with the inverter.  
Clear the alarm with p0971 = 1 and recommission the drive.
  - No alarm A01028: Proceed with the next step.
11. Switch off the inverter power supply.
12. Wait until all LEDs on the inverter go dark.
13. Switch on the inverter power supply again.

The inverter reports the faults F01641, F01650, F01680 and F30680. Ignore these faults, as they will be automatically acknowledged by the following steps.
14. Set p0010 to 95.
15. Set p9761 to the safety password.
16. Set p9701 to AC hex.
17. Set p0010 to 0.
18. Back up the settings so they are not lost when the power fails:
  - BOP-2 in the menu "EXTRAS" - "RAM-ROM".
  - IOP in the menu "SAVE RAM TO ROM".
19. Switch off the inverter power supply.
20. Wait until all LEDs on the inverter go dark.

21. Switch on the inverter power supply again.

22. Perform a **reduced** acceptance test.



Reduced acceptance after component replacement and firmware change  
(Page 397)

- You have replaced the Control Unit and transferred the safety function settings from the Operator Panel to the new Control Unit.

### 8.1.3 Replacing the Control Unit without the safety functions enabled

#### Replacing a Control Unit with data backup on a memory card

If you use a memory card with firmware, after the replacement, you obtain a precise copy (firmware and settings) of the replaced Control Unit.

##### Precondition

You have a memory card with the actual settings of the Control unit to be replaced.

##### Procedure



To replace the Control Unit, proceed as follows:

1. Disconnect the line voltage to the Power Module and (if installed) the external 24 V supply or the voltage for the digital outputs of the Control Unit.
2. Remove the signal cables from the Control Unit.
3. Remove the defective Control Unit.
4. Mount the new Control Unit on the Power Module. The new Control Unit must have the same article number and the same or higher firmware version as the Control Unit that was replaced.
5. Remove the memory card from the old Control Unit and insert it in the new Control Unit.
6. Reconnect the signal cables of the Control Unit.
7. Connect up the line voltage again.
8. The inverter loads the settings from the memory card.
9. After loading, check whether the inverter outputs alarm A01028.
  - Alarm A01028:  
The loaded settings are not compatible with the inverter.  
Clear the alarm with p0971 = 1, and recommission the drive.
  - No alarm A01028:  
The inverter accepts the settings that have been loaded.

- You have successfully replaced the Control Unit.

## Replacing a Control Unit with data backup in the PC

### Precondition

You have backed up the actual settings of the Control Unit to be replaced to a PC using STARTER.

### Procedure



To replace the Control Unit, proceed as follows:

1. Disconnect the line voltage to the Power Module and (if installed) the external 24 V supply or the voltage for the digital outputs of the Control Unit.
2. Remove the signal cables of the Control Unit.
3. Remove the defective Control Unit.
4. Mount the new Control Unit on the Power Module.
5. Reconnect the signal cables of the Control Unit.
6. Connect up the line voltage again.
7. Open the right project for the drive in STARTER.
8. Go online and transfer the settings from the PC to the inverter by pressing the  button. The inverter signals faults after the download. Ignore these faults, as they will be automatically acknowledged by the following steps.
9. Save your settings (copy RAM to ROM).

You have successfully replaced the Control Unit.

## Replacing the Control Unit with data backup in the operator Panel

### Precondition

You have backed up the actual settings of the Control Unit to be replaced to an operator panel.

### Procedure



To replace the Control Unit, proceed as follows:

1. Disconnect the line voltage to the Power Module and (if installed) the external 24 V supply or the voltage for the digital outputs of the Control Unit.
2. Remove the signal cables of the Control Unit.
3. Remove the defective Control Unit.
4. Mount the new Control Unit on the Power Module.
5. Reconnect the signal cables of the Control Unit.
6. Connect up the line voltage again.
7. Plug the Operator Panel into the Control Unit or connect the Operator Panel handheld device with the inverter.
8. Transfer the settings from the Operator Panel to the inverter.
9. Wait until the transfer is complete.
10. After loading, check whether the inverter outputs alarm A01028.
  - Alarm A01028:  
The loaded settings are not compatible with the inverter.  
Clear the alarm with p0971 = 1 and recommission the drive.
  - No alarm A01028: Proceed with the next step.
11. Back up the settings so they are not lost when the power fails:
  - BOP-2 in the menu "EXTRAS" - "RAM-ROM".
  - IOP in the menu "SAVE RAM TO ROM".

- You have replaced the Control Unit and transferred the safety function settings from the operator panel to the new Control Unit.

### 8.1.4 Replacing the Control Unit without data backup

If you do not backup the settings, then you must recommission the drive after replacing the Control Unit.

#### Procedure



To replace the Control Unit without backed-up settings, proceed as follows:

1. Disconnect the line voltage to the Power Module and (if installed) the external 24 V supply or the voltage for the digital outputs of the Control Unit.
2. Remove the signal cables of the Control Unit.
3. Remove the defective Control Unit.
4. Mount the new Control Unit on the Power Module.
5. Reconnect the signal cables of the Control Unit.
6. Switch on the line voltage again.
7. Recommission the drive.



The Control Unit replacement has been completed after the drive has been successfully commissioned.

## 8.1.5 Replacing a Control Unit with active know-how protection

### Replacing devices with know-how protection without copy protection

In the case of know-how protection without copy protection, the inverter settings can be transferred to another inverter using a memory card.



Saving setting on memory card (Page 353)



Transferring the setting from the memory card (Page 357)

### Replacing devices with know-how protection with copy protection



The know-how protection with copy protection hides the inverter settings and also prevents the duplication of the inverter settings.

If the inverter settings can neither be copied nor forwarded, a recommissioning is required after inverter replacement.

To avoid the recommissioning, you must use a Siemens memory card, and the machine manufacturer must have an identical prototype machine that it uses as sample.

There are two options for replacing the device:



#### Option 1: The machine manufacturer only knows the serial number of the new inverter

1. The end customer provides the machine manufacturer with the following information:
  - For which machine must the inverter be replaced?
  - What is the serial number (r7758) of the new inverter?
2. The machine manufacturer performs the following steps online on the prototype machine:
  - Deactivating know-how protection
    -  Settings for know-how protection (Page 373)
  - Enter the serial number of the new inverter in p7759.
  - Enter the serial number of the inserted memory card as reference serial number in p7769.
  - Activate know-how protection with copy protection. "Copy RAM to ROM" must be activated.
    -  Settings for know-how protection (Page 373)
  - Write the configuration with p0971 = 1 to the memory card.
  - Send the memory card to the end customer.
3. The end customer inserts the memory card and switches on the power supply for the inverter.

When powering up, the inverter checks the serial numbers of the card and when there is a match, the inverter goes into the "ready to start" state.

If the numbers do not match, then the inverter signals fault F13100 (no valid memory card).

**Option 2: The machine manufacturer knows the serial number of the new inverter and the serial number of the memory card**

1. The end customer provides the machine manufacturer with the following information:
  - For which machine must the inverter be replaced?
  - What is the serial number (r7758) of the new inverter?
  - What is the serial number of the memory card?
2. The machine manufacturer performs the following steps online on the prototype machine:
  - Deactivating know-how protection
    -  Settings for know-how protection (Page 373)
  - Enter the serial number of the new inverter in p7759.
  - Enter the serial number of the customer's memory card as reference serial number in p7769.
  - Activate know-how protection with copy protection. "Copy RAM to ROM" must be activated.
    -  Settings for know-how protection (Page 373)
  - Write the configuration with p0971 = 1 to the memory card.
  - Copy the encrypted project from the card to the associated PC.
  - Send the encrypted project to the end customer, e.g. via e-mail.
3. The end customer copies the project to the Siemens memory card that belongs to the machine, inserts it in the inverter and switches on the power supply for the inverter.

When powering up, the inverter checks the serial numbers of the card and when there is a match, the inverter goes into the "ready to start" state.

If the numbers do not match, then the inverter signals fault F13100 (no valid memory card).



## 8.1.6 Replacing a Power Module with enabled safety function



### DANGER

#### Danger from touching energized Power Module connections

After switching off the line voltage, it will take up to 5 minutes until the capacitors in the Power Module are sufficiently discharged for the residual voltage to be safe. Death or serious injury will result if energized parts are touched.

- Check the safe isolation of the Power Module connections before carrying out installation work.

### NOTICE

#### Material damage from swapping the motor's connection lines

The direction in which the motor rotates switches if you swap the two phases of the motor line. A motor running backwards may damage the machine or installation.

- Connect the three phases of the motor lines in the right order.
- After replacing the Power Module, check the direction of motor rotation.

### Procedure



To replace the Power Module, proceed as follows:

1. Switch off the line voltage of the Power Module.  
You can leave any external 24 V supply to the Control Unit switched on.
2. Remove the connecting cables of the Power module.
3. Remove the Control Unit from the Power Module.
4. Replace the Power Module.
5. Mount the Control Unit onto the new Power Module.
6. Connect up the new Power Module using the connecting cables.
7. Switch on the line supply and, if necessary, the 24 V supply for the Control Unit.
8. The inverter reports F01641.
9. Perform a reduced acceptance test.



Reduced acceptance after component replacement and firmware change  
(Page 397)



You have successfully replaced the Power Module.

### 8.1.7 Replacing a Power Module without the safety function being enabled

#### Procedure



Proceed as follows to exchange a Power Module:

1. Switch off the supply voltage to the Power Module.  
You do not have to switch off an external 24 V power supply for the Control Unit if one is being used.



<b>! DANGER</b>
<b>Danger to life from hazardous voltage at the inverter terminals</b>
After the power supply has been switched off, it takes up to 5 min. until the capacitors in the inverter have discharged so that the remaining voltage is non-hazardous.
<ul style="list-style-type: none"><li>• Check the voltage at the inverter connections, before removing the connection cables.</li></ul>

2. Remove the connecting cables of the Power Module.
3. Remove the Control Unit from the Power Module.
4. Replace the old Power Module with the new Power Module.
5. Mount the Control Unit onto the new Power Module.
6. Connect up the new Power Module using the connecting cables.

<b>NOTICE</b>
<b>Material damage when interchanging the motor connecting cables</b>
The direction in which the motor rotates switches if you exchange the two phases of the motor line.
<ul style="list-style-type: none"><li>• Connect the three phases of the motor lines in the right order.</li><li>• After exchanging the power module check the direction in which the motor rotates.</li></ul>

7. Switch on the line supply and, if being used, the 24 V supply of the Control Unit.



You have successfully replaced the Power Module.

## 8.2 Firmware upgrade and downgrade

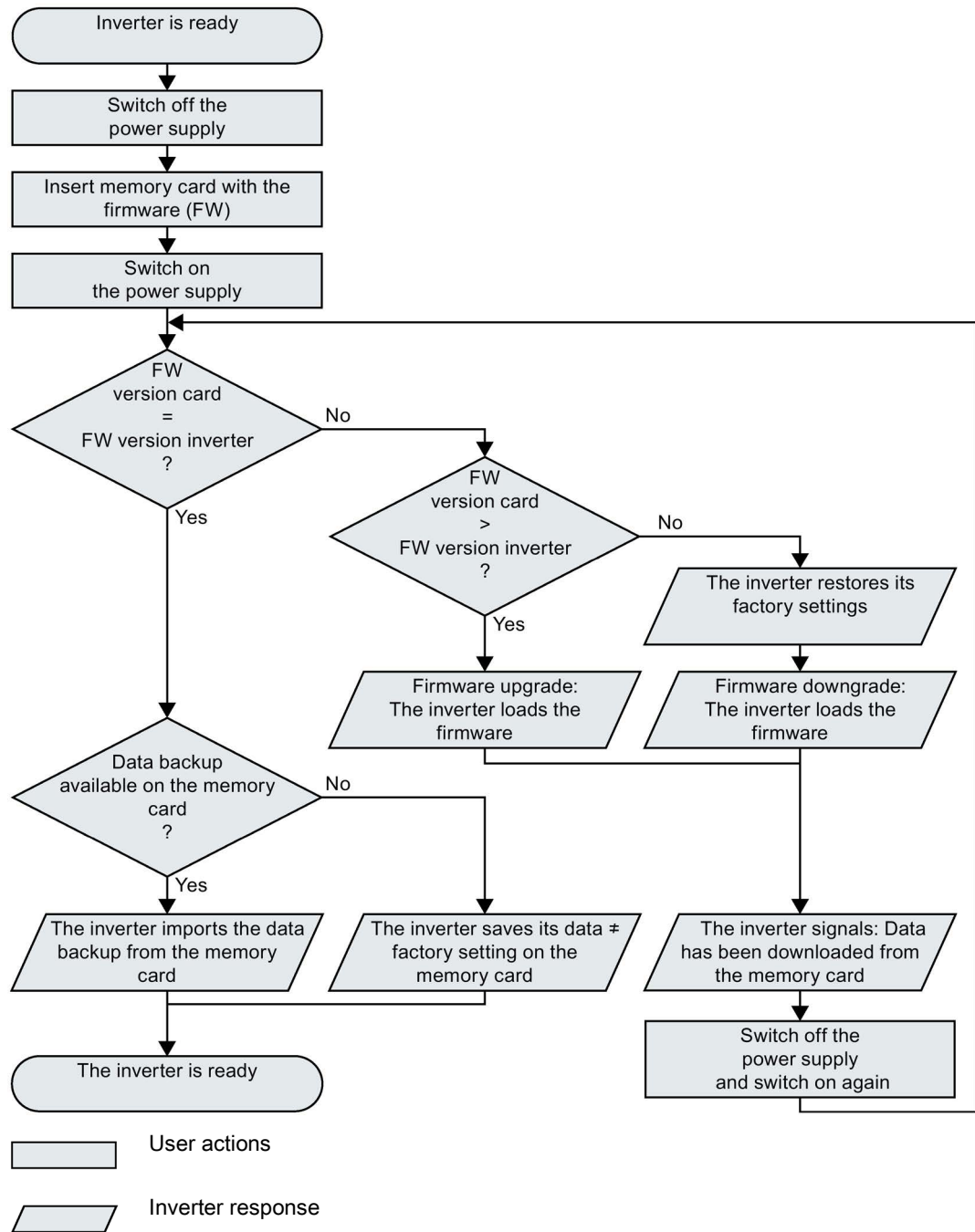

Image 8-1 Overview of the firmware upgrade and firmware downgrade



Further information is provided in the Internet: Download  
<https://support.industry.siemens.com/cs/ww/en/view/67364620>

### 8.2.1 Upgrading the firmware

When upgrading the firmware, you replace the inverter firmware by a later version. Only update the firmware to a later version if you require the expanded functional scope of the newer version.

#### Precondition

- The firmware version of your inverter is at least V4.5.
- Inverter and memory card have different firmware versions.

#### Procedure



Proceed as follows to upgrade the inverter firmware to a later version:

1. Switch off the inverter power supply.
2. Wait until all LEDs on the inverter are dark.

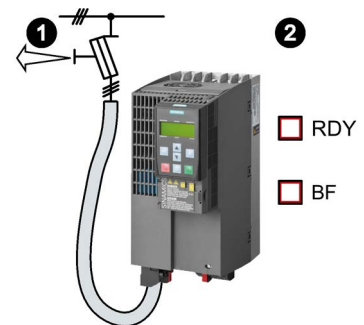

3. Insert the card with the matching firmware into the inverter slot until it latches into place.

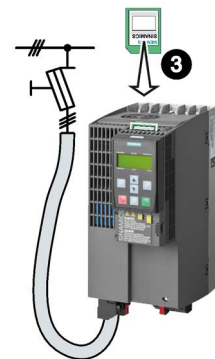

4. Switch on the inverter power supply again.
5. The inverter transfers the firmware from the memory card into its memory.  
The transfer takes approximately 5 ... 10 minutes.  
While data is being transferred, the LED RDY on the inverter stays red. The LED BF flashes orange with a variable frequency.

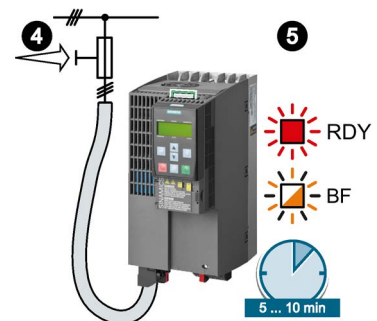

6. At the end of the transfer, the LED RDY and BF slowly flash red (0.5 Hz).

#### Power supply failure during transfer

The inverter firmware will be incomplete if the power supply fails during the transfer.

- Start again with step 1 of the instructions.

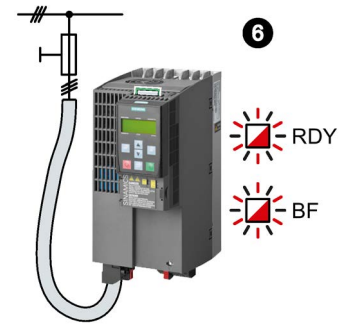

7. Switch off the inverter power supply.  
8. Wait until all LEDs on the inverter are dark.

Decide whether you will withdraw the memory card from the inverter:

- You leave the memory card in the inverter:
  - ⇒ If the memory card still does not have a data backup of the inverter settings, in step 9 the inverter writes its settings to the memory card.
  - ⇒ If the memory card already includes a data backup, the inverter imports the settings from the memory card in step 9.
- You remove the memory card: ⇒ The inverter retains its settings.

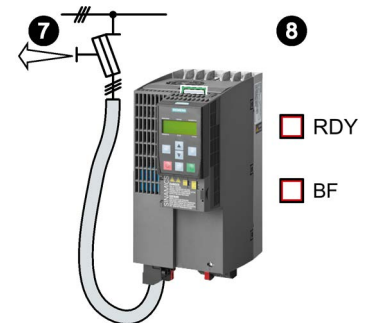

9. Switch on the inverter power supply again.  
10. If the firmware upgrade was successful, after several seconds the inverter LED RDY turns green.

If the memory card is still inserted, depending on the previous content of the memory card, one of the two following cases has occurred:

- The memory card contains a data backup: ⇒ The inverter has taken the settings from the memory card.
- There was no data back up on the memory card: ⇒ The inverter has written its settings to the memory card.

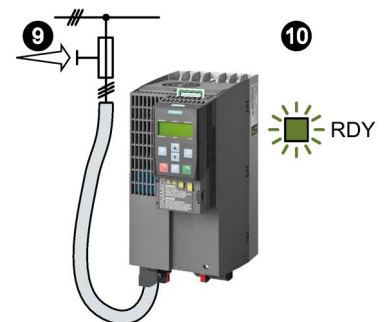

■ You have upgraded the inverter firmware.

### 8.2.2 Firmware downgrade

When downgrading the firmware, you replace the inverter firmware by an older version. Only downgrade the firmware to an older version if, after replacing an inverter, you require the same firmware in all of your inverters.

#### Precondition

- The firmware version of your inverter is at least V4.6.
- Inverter and memory card have different firmware versions.
- You have backed up your settings on the memory card, in an Operator Panel or in a PC.

#### Procedure



Proceed as follows to downgrade the inverter firmware to an older version:

1. Switch off the inverter power supply.
2. Wait until all LEDs on the inverter are dark.

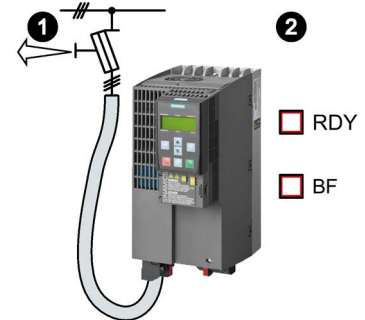

3. Insert the card with the matching firmware into the inverter slot until it latches into place.

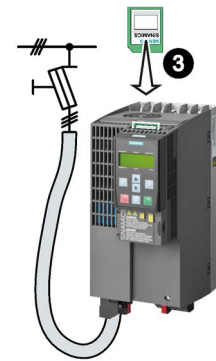

4. Switch on the inverter power supply again.
5. The inverter transfers the firmware from the memory card into its memory.

The transfer takes approximately 5 ... 10 minutes.

While data is being transferred, the LED RDY on the inverter stays red. The LED BF flashes orange with a variable frequency.

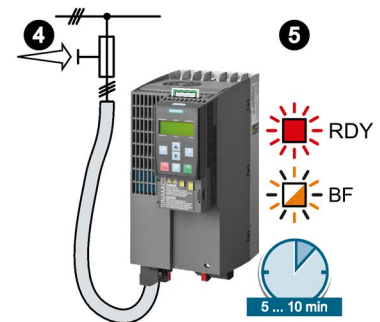

6. At the end of the transfer, the LED RDY and BF slowly flash red (0.5 Hz).

**Power supply failure during transfer**

The inverter firmware will be incomplete if the power supply fails during the transfer.

- Start again with Step 1 of these instructions.

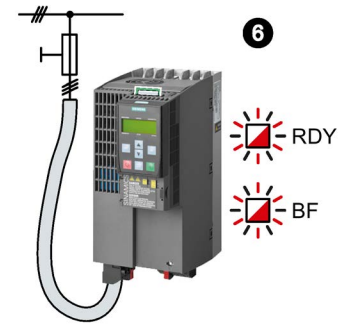

7. Switch off the inverter power supply.  
8. Wait until all LEDs on the inverter are dark.

Decide whether you want to withdraw the memory card from the inverter:

- The memory card contains a data backup: ⇒ The inverter has taken the settings from the memory card.
- There was no data backup on the memory card: ⇒ The inverter has the factory settings.

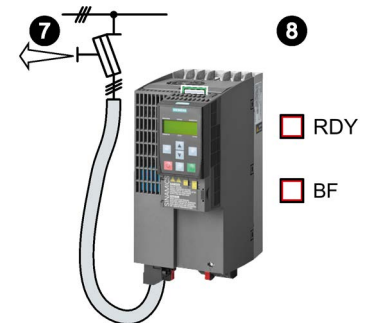

9. Switch on the inverter power supply again.  
10. If the firmware downgrade was successful, after several seconds the inverter LED RDY turns green.

If the memory card is still inserted, depending on the previous content of the memory card, one of the two following cases has occurred:

- The memory card contains a data backup: ⇒ The inverter has taken the settings from the memory card.
- There was no data backup on the memory card: ⇒ The inverter has the factory settings.

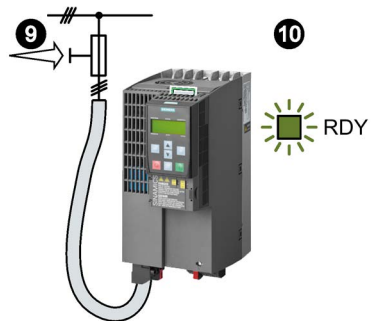

11. If the memory card did not contain a data backup of the inverter settings, then you must transfer your settings to the inverter from another data backup.

 Backing up data and series commissioning (Page 351)

-  You have replaced the inverter's firmware by an older version.

### 8.2.3 Correcting an unsuccessful firmware upgrade or downgrade

How does the inverter signal an unsuccessful upgrade or downgrade?



The inverter signals an unsuccessful firmware upgrade or downgrade by a quickly flashing LED RDY and the lit LED BF.

#### Correcting an unsuccessful upgrade or downgrade

You can check the following to correct an unsuccessful firmware upgrade or downgrade:

- Does the firmware version of your inverter fulfill the preconditions?
  - For an upgrade, as a minimum V4.5.
  - For a downgrade, as a minimum V4.6.
- Have you correctly inserted the card?
- Does the card contain the correct firmware?
- Repeat the appropriate procedure.



## 8.3 Reduced acceptance after component replacement and firmware change

After a component has been replaced or the firmware updated, a reduced acceptance test of the safety functions must be performed.

Measure	Acceptance test	
	Acceptance test	Documentation
Replacing the Control Unit.	No. Only check the direction of rotation of the motor.	<ul style="list-style-type: none"> <li>• Supplement inverter data</li> <li>• Log the new checksums</li> <li>• Countersignature</li> </ul>
Replacing the Power Module.		Supplement the hardware version in the inverter data
Replace the motor with an identical pole pair number		No change.
Replace the gearbox with an identical ratio		No change.
Replacing safety-related peripherals (e.g. Emergency Stop switch).	No. Only check the control of the safety functions that are influenced by the components that have been replaced.	No change.
Inverter firmware update.	No.	<ul style="list-style-type: none"> <li>• Supplement firmware version in the inverter data</li> <li>• Log the new checksums</li> <li>• Countersignature.</li> </ul>

## 8.4 If the converter no longer responds

### If the inverter no longer responds

For example, when loading an incorrect file from the memory card, the inverter can go into a state where it can no longer respond to commands from the operator panel or from a higher-level control system. In this case, you must reset the inverter to its factory setting and recommission it. This inverter state is manifested in two different ways:

#### Case 1

- The motor is switched off.
- You cannot communicate with the inverter, either via the operator panel or other interfaces.
- The LEDs flicker and after 3 minutes the inverter has still not powered up.

#### Procedure



Proceed as follows to restore the inverter factory settings:

1. Remove the memory card if one is inserted in the inverter.
2. Switch off the inverter power supply.
3. Wait until all LEDs on the inverter go dark. Then switch on the inverter power supply again.
4. Repeat steps 2 and 3 as often as required until the inverter outputs fault F01018:
5. Set p0971 = 1.
6. Switch off the inverter power supply.
7. Wait until all LEDs on the inverter go dark. Then switch on the inverter power supply again.

The inverter now powers up with the factory settings.

8. Recommission the inverter.



You have restored the inverter factory settings.

**Case 2**

- The motor is switched off.
- You cannot communicate with the inverter, either via the operator panel or other interfaces.
- The LEDs flash and are dark - this process is continually repeated.

**Procedure**

Proceed as follows to restore the inverter factory settings:

1. Remove the memory card if one is inserted in the inverter.
2. Switch off the inverter power supply.
3. Wait until all LEDs on the inverter go dark. Then switch on the inverter power supply again.
4. Wait until the LEDs flash orange.
5. Repeat steps 2 and 3 as often as required until the inverter outputs fault F01018.
6. Now set p0971 = 1.
7. Switch off the inverter power supply.
8. Wait until all LEDs on the inverter go dark. Then switch on the inverter power supply again.

The inverter now powers up with the factory settings.

9. Recommission the inverter.

You have restored the inverter factory settings.

**The motor cannot be switched-on**

If the motor cannot be switched-on, then check the following:

- Is a fault present?  
If there is, then remove the fault cause and acknowledge the fault.
- Has the inverter been completely commissioned p0010 = 0?  
If not, the inverter is e.g. still in a commissioning state.
- Is the inverter reporting the "ready to start" status (r0052.0 = 1)?
- Is the inverter missing some enable signals (r0046)?
- How does the inverter receive its setpoint and commands?  
Digital inputs, analog inputs or fieldbus?



# Alarms, faults and system messages

The converter has the following diagnostic types:

- LED

The LED at the front of the converter immediately informs you about the most important converter states.

- Alarms and faults

The converter signals alarms and faults via

- the fieldbus
- the terminal strip with the appropriate setting
- a connected operator panel, or
- STARTER

Alarms and faults have a unique number.

- Identification & maintenance data (I&M)

If requested, the converter sends data to the higher-level control via PROFIBUS or PROFINET:

- Converter-specific data
- Plant-specific data

## 9.1 Operating states indicated on LEDs

The LED RDY (Ready) is temporarily orange after the power supply voltage is switched-on. As soon as the color of the LED RDY changes to either red or green, the LEDs signal the inverter state.

### Signal states of the LED

In addition to the signal states "on" and "off" there are two different flashing frequencies:

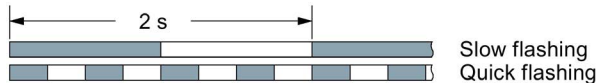

Table 9- 1 Inverter diagnostics

LED		Explanation
RDY	BF	
GREEN - on	Not relevant	There is presently no fault
GREEN - slow		Commissioning or reset to factory settings
RED - on	YELLOW - variable frequency	Firmware update in progress
RED - slow	RED - slow	Inverter waits until the power supply is switched off and switched on again after a firmware update
RED - fast	Not relevant	There is presently a fault
RED - fast	RED - fast	Incorrect memory card or unsuccessful firmware update

Table 9- 2 Diagnostics of the safety functions

SAFE LED	Meaning
YELLOW - on	One or more safety functions are enabled, but not active.
YELLOW - slow	One or more safety functions are active; no safety function faults have occurred.
YELLOW - rapid	The converter has detected a safety function fault and initiated a STOP response.

Table 9- 3 Communication diagnostics via PROFINET

LNK LED	Explanation
GREEN - on	The communication via PROFINET is in order.
GREEN - slow	Device naming is active.
Off	No communication via PROFINET.

Table 9- 4 Communication diagnostics via RS485

LED		Explanation
BF	RDY	
off	Not relevant	Data exchange between the inverter and control system is active
RED - slow	RED - slow	Inverter waits until the power supply is switched off and switched on again after a firmware update
	All other states	The bus is active, however the inverter is not receiving any process data
RED - fast	RED - fast	Incorrect parameterization, incorrect memory card or firmware update unsuccessful
	All other states	No bus connection available
YELLOW - variable frequency	RED - on	Firmware update in progress

**Communication via Modbus or USS:**

If the fieldbus monitoring is deactivated with p2040 = 0, the BF-LED remains dark, independent of the communication state.

Table 9- 5 Communication diagnostics via PROFIBUS DP

LED		Explanation
BF	RDY	
GREEN - on	Not relevant	Data exchange between the inverter and control system is active
off		PROFIBUS interface is not being used.
RED - slow	RED - slow	Inverter waits until the power supply is switched off and switched on again after a firmware update
	All other states	Bus fault - configuration fault
RED - fast	RED - fast	Incorrect memory card or unsuccessful firmware update
	All other states	Bus error - no data exchange - inverter searches for baud rate - no connection
YELLOW - variable frequency	RED - on	Firmware update in progress

## 9.2 System runtime

By evaluating the system runtime of the inverter, you can decide whether you must replace components subject to wear such as fans, motors and gear units.

### Principle of operation

The inverter starts the system runtime as soon as the inverter is supplied with power. The system runtime stops when the inverter is switched off.

The system runtime comprises r2114[0] (milliseconds) and r2114[1] (days):

System runtime = r2114[1] × days + r2114[0] × milliseconds

If r2114[0] has reached a value of 86,400,000 ms (24 hours), the inverter sets r2114[0] the value 0 and increases the value of r2114[1] by 1.

Using system runtime, you can track the chronological sequence of faults and alarms over time. When a corresponding message is triggered, the inverter transfers the parameter values r2114 to the corresponding parameters of the alarm or fault buffer.

Parameters	Description
r2114[0]	System runtime (ms)
r2114[1]	System runtime (days)

You cannot reset the system runtime.



## 9.3 Alarms

Alarms have the following properties:

- They do not have a direct effect in the inverter and disappear once the cause has been removed
- They do not need have to be acknowledged
- They are signaled as follows
  - Status display via bit 7 in status word 1 (r0052)
  - on the Operator Panel with a Axxxxx
  - Via STARTER, if you click on TAB  at the bottom left of the STARTER screen

In order to pinpoint the cause of an alarm, there is a unique alarm code and also a value for each alarm.

### Alarm buffer

For each incoming alarm, the inverter saves the alarm, alarm value and the time that the alarm was received.

	Alarm code	Alarm value		Alarm time received		Alarm time removed	
1. Alarm	r2122[0]	r2124[0]	r2134[0]	r2145[0]	r2123[0]	r2146[0]	r2125[0]
		l32	Float	Days	ms	Days	ms

Image 9-1 Saving the first alarm in the alarm buffer

r2124 and r2134 contain the alarm value (important for diagnostics) as "fixed point" or "floating point" number.

The alarm times are displayed in r2145 and r2146 (in complete days) as well as in r2123 and r2125 (in milliseconds referred to the day of the alarm). The inverter uses its internal time calculation to save the alarm times.

 System runtime (Page 404)

As soon as the alarm has been removed, the inverter writes the associated instant in time into parameters r2125 and r2146. The alarm remains in the alarm buffer even if the alarm has been removed.

If an additional alarm is received, then this is also saved. The first alarm is still saved. The alarms that have occurred are counted in p2111.

	Alarm code	Alarm value		Alarm time received		Alarm time, resolved	
1st alarm	r2122[0]	r2124[0]	r2134[0]	r2145[0]	r2123[0]	r2146[0]	r2125[0]
2nd alarm	[1]	[1]	[1]	[1]	[1]	[1]	[1]

Image 9-2 Saving the second alarm in the alarm buffer

9.3 Alarms

The alarm buffer can contain up to eight alarms. If an additional alarm is received after the eighth alarm - and none of the last eight alarms have been removed - then the next to last alarm is overwritten.

	Alarm code	Alarm value		Alarm time received		Alarm time, resolved	
1st alarm	r2122[0]	r2124[0]	r2134[0]	r2145[0]	r2123[0]	r2146[0]	r2125[0]
2nd alarm	[1]	[1]	[1]	[1]	[1]	[1]	[1]
3rd alarm	[2]	[2]	[2]	[2]	[2]	[2]	[2]
4th alarm	[3]	[3]	[3]	[3]	[3]	[3]	[3]
5th alarm	[4]	[4]	[4]	[4]	[4]	[4]	[4]
6th alarm	[5]	[5]	[5]	[5]	[5]	[5]	[5]
7th alarm	[6]	[6]	[6]	[6]	[6]	[6]	[6]
Last alarm	[7]	[7]	[7]	[7]	[7]	[7]	[7]

Image 9-3 Complete alarm buffer

Emptying the alarm buffer: Alarm history

The alarm history traces up to 56 alarms.

The alarm history only takes alarms that have been removed from the alarm buffer. If the alarm buffer is completely filled - and an additional alarm occurs - then the inverter shifts all alarms that have been removed from the alarm buffer into the alarm history. In the alarm history, alarms are also sorted according to the "alarm time received", however, when compared to the alarm buffer, in the inverse sequence:

- The youngest alarm is in index 8
- The second youngest alarm is in index 9
- etc.

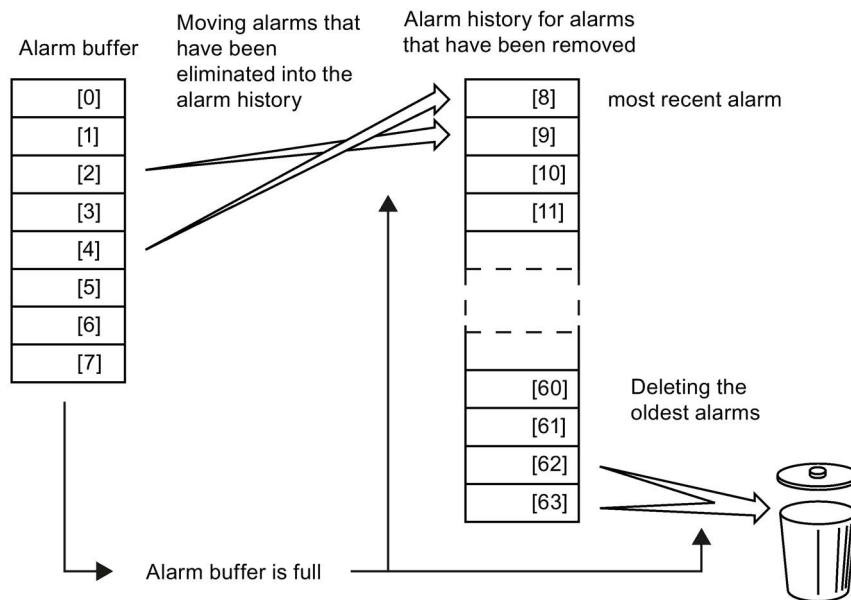

Image 9-4 Shifting alarms that have been removed into the alarm history

Any alarms that have not been removed remain in the alarm buffer. The inverter sorts the alarms and closes gaps between the alarms.

If the alarm history is filled up to index 63, each time a new alarm is accepted in the alarm history, the oldest alarm is deleted.

### Parameters of the alarm buffer and the alarm history

Parameter	Description
r2122	<b>Alarm code</b> Displays the numbers of alarms that have occurred
r2123	<b>Alarm time received in milliseconds</b> Displays the time in milliseconds when the alarm occurred
r2124	<b>Alarm value</b> Displays additional information about the alarm
r2125	<b>Alarm time removed in milliseconds</b> Displays the time in milliseconds when the alarm was removed
p2111	<b>Alarm counter</b> Number of alarms that have occurred after the last reset When setting p2111 = 0, all of the alarms that have been removed from the alarm buffer [0...7] are transferred to the alarm history [8...63]
r2145	<b>Alarm time received in days</b> Displays the time in days when the alarm occurred
r2132	<b>Actual alarm code</b> Displays the code of the alarm that last occurred
r2134	<b>Alarm value for float values</b> Displays additional information about the alarm that occurred for float values
r2146	<b>Alarm time removed in days</b> Displays the time in days when the alarm was removed

### Extended settings for alarms

Parameter	Description
You can change up to 20 different alarms into a fault or suppress alarms:	
p2118	<b>Setting the message number for the message type</b> Selection of the alarms for which the message type should be changed
p2119	<b>Setting the message type</b> Setting the message type for the selected alarm 1: Fault 2: Alarm 3: No message

You will find details in function diagram 8075 and in the parameter description of the List Manual.

## 9.4 Faults

A fault indicates a severe fault during inverter operation.

The inverter signals a fault as follows:

- At the Operator Panel with Fxxxx
- At the inverter using the red LED RDY
- In bit 3 of status word 1 (r0052)
- Via STARTER

To delete a message, you must resolve the cause of the fault and acknowledge the fault.

Every fault has a unique fault code and also a fault value. You need this information to determine the cause of the fault.

### Fault buffer of actual values

The inverter saves the time, fault code and fault value for every fault it receives.

	Fault code	Fault value	Fault time received	Fault time removed
1st fault	r0945[0]	r0949[0] r2133[0]  32 Float	r2130[0] r0948[0] Days ms	r2136[0] r2109[0] Days ms

Image 9-5 Saving the first fault in the fault buffer

r0949 and r2133 contain the fault value (important for diagnostics) as "fixed point" or "floating point" number.

The "fault time received" is in parameter r2130 (in complete days) as well as in parameter r0948 (in milliseconds referred to the day of the fault). The "fault time removed" is written to parameters r2109 and r2136 when the fault has been acknowledged. The inverter uses its internal time calculation to save the fault times.

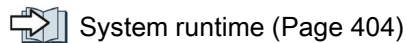

System runtime (Page 404)

If an additional fault occurs before the first fault has been acknowledged, then this is also saved. The first alarm remains saved. The fault cases that have occurred are counted in p0952. A fault case can contain one or several faults.

	Fault code	Fault value	Fault time received	Fault time removed
1st fault	r0945[0]	r0949[0] r2133[0]	r2130[0] r0948[0]	r2136[0] r2109[0]
2nd fault	[1]	[1] [1]	[1] [1]	[1] [1]

Image 9-6 Saving the second fault in the fault buffer

The fault buffer can accept up to eight actual faults. The next to last fault is overwritten if an additional fault occurs after the eighth fault.

	Fault code	Fault value		Fault time received		Fault time removed	
1st fault	r0945[0]	r0949[0]	r2133[0]	r2130[0]	r0948[0]	r2136[0]	r2109[0]
2nd fault	[1]	[1]	[1]	[1]	[1]	[1]	[1]
3rd fault	[2]	[2]	[2]	[2]	[2]	[2]	[2]
4th fault	[3]	[3]	[3]	[3]	[3]	[3]	[3]
5th fault	[4]	[4]	[4]	[4]	[4]	[4]	[4]
6th fault	[5]	[5]	[5]	[5]	[5]	[5]	[5]
7th fault	[6]	[6]	[6]	[6]	[6]	[6]	[6]
Last fault	[7]	[7]	[7]	[7]	[7]	[7]	[7]

Image 9-7 Complete fault buffer

## Acknowledgement

You have multiple options to acknowledge a fault, e.g.:

- PROFIdrive control word 1, bit 7 (r2090.7)
- Acknowledge via the Operator Panel
- Switch-off the inverter power supply and switch-on again.

Faults detected during the inverter-internal monitoring of hardware and firmware can be acknowledged only by switching the supply voltage off and on again. The list of faults in the List Manual contains a note on this limited acknowledgement possibility.

## Emptying the fault buffer: Fault history

The fault history can contain up to 56 faults.

The acknowledgement has no effect as long as none of the causes for the faults in the buffer have been removed. If at least one of the faults in the fault buffer has been removed (the cause of the fault has been removed) and you acknowledge the faults, then the following happens:

1. The inverter accepts all faults from the fault buffer in the first eight memory locations of the fault history (indexes 8 ... 15).
2. The inverter deletes the faults that have been removed from the fault buffer.
3. The inverter writes the time of acknowledgement of the faults that have been removed into parameters r2136 and r2109 (fault time removed).

9.4 Faults

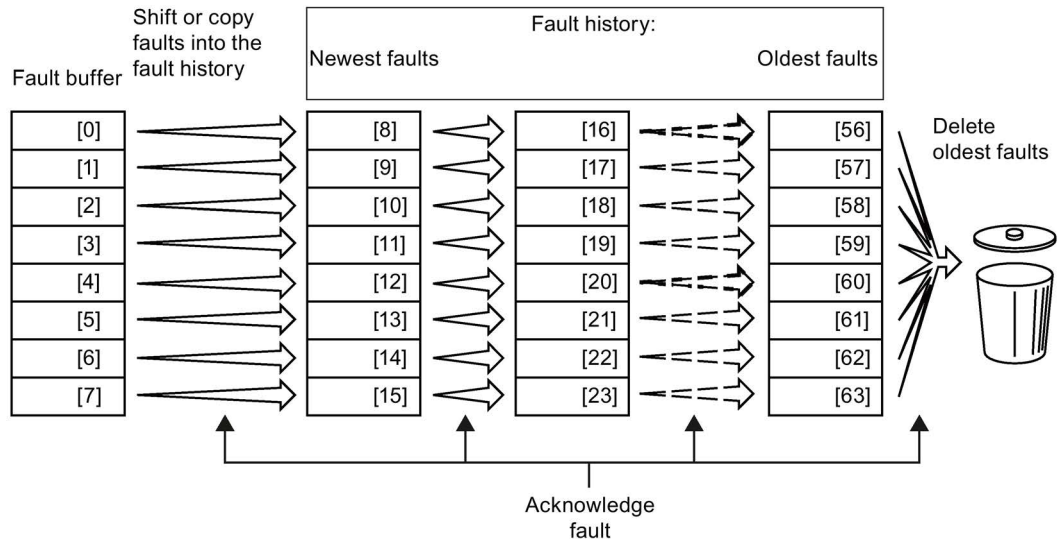

Image 9-8 Fault history after acknowledging the faults

After acknowledgement, the faults that have not been removed are located in the fault buffer as well as in the fault history. For these faults, the "fault time coming" remains unchanged and the "fault time removed" remains empty.

If less than eight faults were shifted or copied into the fault history, the memory locations with the higher indexes remain empty.

The inverter shifts the values previously saved in the fault history by eight indexes. Faults, which were saved in indexes 56 ... 63 before the acknowledgement, are deleted.

**Deleting the fault history**

If you wish to delete all faults from the fault history, set parameter p0952 to zero.

## Parameters of the fault buffer and the fault history

Parameter	Description
r0945	<b>Fault code</b> Displays the numbers of faults that have occurred
r0948	<b>Fault time received in milliseconds</b> Displays the time in milliseconds when the fault occurred
r0949	<b>Fault value</b> Displays additional information about the fault
p0952	<b>Fault cases, counter</b> Number of fault cases that have occurred since the last acknowledgement. The fault buffer is deleted with p0952 = 0.
r2109	<b>Fault time removed in milliseconds</b> Displays the time in milliseconds when the fault occurred
r2130	<b>Fault time received in days</b> Displays the time in days when the fault occurred
r2131	<b>Actual fault code</b> Displays the code of the oldest fault that is still active
r2133	<b>Fault value for float values</b> Displays additional information about the fault that occurred for float values
r2136	<b>Fault time removed in days</b> Displays the time in days when the fault was removed

## Extended settings for faults

Parameter	Description
You can modify the motor fault response for up to 20 different fault codes:	
p2100	<b>Setting the fault number for fault response</b> Selecting the faults for which the fault response should be changed
p2101	<b>Setting, fault response</b> Setting the fault response for the selected fault
You can modify the acknowledgement type for up to 20 different fault codes:	
p2126	<b>Setting the fault number for the acknowledgement mode</b> Selection of the faults for which the acknowledgement type should be changed
p2127	<b>Setting, acknowledgement mode</b> Setting the acknowledgement type for the selected fault 1: Can only be acknowledged using POWER ON 2: IMMEDIATE acknowledgement after removing the fault cause
You can change up to 20 different faults into an alarm, or suppress faults:	
p2118	<b>Setting the message number for the message type</b> Selection of the message for which the message type should be changed
p2119	<b>Setting the message type</b> Setting the message type for the selected fault 1: Fault 2: Alarm 3: No message

You will find details in function diagram 8075 and in the parameter description of the List Manual.



## 9.5 List of alarms and faults

Axxxxx Alarm

Fyyyyy: Fault

Table 9- 6 The most important alarms and faults of the safety functions

Number	Cause	Remedy
F01600	STOP A Triggered	STO Select and then deselect again.
F01650	Acceptance test required	Carry out acceptance test and create test certificate. Switch the Control Unit off and then on again.
F01659	Write task for parameter rejected	Cause: The converter should be reset to the factory setting. The resetting of the safety functions is, however, not allowed, because the safety functions are currently enabled.
		Remedy with operator panel:
		p0010 = 30      Parameter reset
		p9761 = ...      Enter password for the safety functions.
		p0970 = 5      Reset Start Safety Parameter. The converter sets p0970 = 5 if it has reset the parameters.
Then reset the converter to the factory setting again.		
A01666	Static 1 signal at F-DI for safe acknowledgment	F-DI to a logical 0 signal.
A01698	Commissioning mode active for safety functions	This message is withdrawn after the Safety commissioning has ended.
A01699	Shutdown path test required	After the next time that the "STO" function is deselected, the message is withdrawn and the monitoring time is reset.
F30600	STOP A Triggered	STO Select and then deselect again.

## 9.5 List of alarms and faults

Table 9- 7 Faults, which can only be acknowledged by switching the inverter off and on again

Number	Cause	Remedy
F01000	Software fault in CU	Replace CU.
F01001	Floating Point Exception	Switch CU off and on again.
F01015	Software fault in CU	Upgrade firmware or contact technical support.
F01018	Power-up aborted more than once	After this fault is output, the inverter powers up with the factory settings. Remedy: Back up factory setting with p0971=1. Switch CU off and on again. Recommission the inverter.
F01040	Parameters must be saved	Save parameters (p0971). Switch CU off and on again.
F01044	Loading of memory data card defective	Replace memory card or CU.
F01105	CU: Insufficient memory	Reduce number of data records.
F01205	CU: Time slice overflow	Contact technical support.
F01250	CU hardware fault	Replace CU.
F01512	An attempt has been made to establish an conversion factor for scaling which is not present	Create scaling or check transfer value.
F01662	CU hardware fault	Switch CU off and on again, upgrade firmware, or contact technical support.
F30022	Power Module: Monitoring $U_{CE}$	Check or replace the Power Module.
F30052	Incorrect Power Module data	Replace Power Module or upgrade CU firmware.
F30053	Error in FPGA data	Replace the Power Module.
F30662	CU hardware fault	Switch CU off and on again, upgrade firmware, or contact technical support.
F30664	CU power up aborted	Switch CU off and on again, upgrade firmware, or contact technical support.
F30850	Software fault in Power Module	Replace Power Module or contact technical support.

Table 9- 8 The most important alarms and faults

Number	Cause	Remedy
F01018	Power-up aborted more than once	<ol style="list-style-type: none"> <li>1. Switch the module off and on again.</li> <li>2. After this fault has been output, the module is booted with the factory settings.</li> <li>3. Recommission the inverter.</li> </ol>
A01028	Configuration error	<p>Explanation: Parameterization on the memory card has been created with a different type of module (Article number, MLFB).</p> <p>Check the module parameters and recommission if necessary.</p>
F01033	Switching over units: Reference parameter value invalid	Set the value of the reference parameter not equal to 0.0 (p0304, p0305, p0310, p0596, p2000, p2001, p2002, p2003, r2004).
F01034	Switching over units: Calculation of the parameter values after reference value change unsuccessful	Select the value of the reference parameter so that the parameters involved can be calculated in the per unit notation (p0304, p0305, p0310, p0596, p2000, p2001, p2002, p2003, r2004).
A01053	System overload measured	<p>The maximum computing power of the Control Unit was exceeded. The following measures reduce the load on the Control Unit:</p> <ul style="list-style-type: none"> <li>• Use only one data record (CDS and DDS)</li> <li>• Only use the safety features of the basic functions</li> <li>• Deactivate the technology controller</li> <li>• Use the simple ramp-function generator rather than the extended ramp-function generator</li> <li>• Do not use any free function components</li> <li>• Reduce the sampling time of the free function blocks</li> </ul>
F01054	System limit exceeded	
F01122	Frequency at the probe input too high	Reduce the frequency of the pulses at the probe input.
A01590	Motor maintenance interval elapsed	Carry out maintenance and reset the maintenance interval (p0651).
A01900	PROFIBUS: Configuration telegram faulty	<p>Explanation: A PROFIBUS master is attempting to establish a connection with a faulty configuration telegram.</p> <p>Check the bus configuration on the master and slave side.</p>
A01910 F01910	Setpoint timeout	<p>The alarm is generated when p2040 <math>\neq</math> 0 ms and one of the following causes is present:</p> <ul style="list-style-type: none"> <li>• The bus connection is interrupted</li> <li>• The Modbus master is switched off</li> <li>• Communications error (CRC, parity bit, logical error)</li> <li>• An excessively low value for the fieldbus monitoring time (p2040)</li> </ul>
A01920	PROFIBUS: Cyclic connection interrupt	<p>Explanation: The cyclic connection to PROFIBUS master is interrupted.</p> <p>Establish the PROFIBUS connection and activate the PROFIBUS master with cyclic operation.</p>
F03505	Analog input, wire-break	<p>Check the wiring for interruptions.</p> <p>Check the level of the injected signal.</p> <p>The input current measured by the analog input can be read out in r0752.</p>
A03520	Temperature sensor fault	Check that the sensor is connected correctly.

9.5 List of alarms and faults

Number	Cause	Remedy
A05000 A05001 A05002 A05004 A05006	Power Module overtemperature	Check the following: - Is the ambient temperature within the defined limit values? - Are the load conditions and duty cycle configured accordingly? - Has the cooling failed?
F06310	Supply voltage (p0210) incorrectly set	Check the set supply voltage and if required change (p0210). Check the line voltage.
F07011	Motor overtemperature	Reduce the motor load. Check the ambient temperature. Check the wiring and connection of the sensor.
A07012	I2t Motor Module overtemperature	Check and if necessary reduce the motor load. Check the motor's ambient temperature. Check the thermal time constant p0611. Check the overtemperature fault threshold p0605.
A07015	Motor temperature sensor alarm	Check that the sensor is connected correctly. Check the parameter assignment (p0601).
F07016	Motor temperature sensor fault	Make sure that the sensor is connected correctly. Check the parameterization (p0601). Deactivate the motor temperature sensor fault evaluation (p0607 = 0).
F07086 F07088	Switching over units: Parameter limit violation	Check the adapted parameter values and if required correct.
F07320	Automatic restart aborted	Increase the number of restart attempts (p1211). The actual number of start attempts is shown in r1214. Increase the wait time in p1212 and/or monitoring time in p1213. Connect an ON command (p0840). Increase the monitoring time of the power unit or switch off (p0857). Reduce the wait time for resetting the fault counter p1213[1] so that fewer faults are registered in the time interval.
A07321	Automatic restart active	Explanation: The automatic restart (AR) is active. During voltage recovery and/or when remedying the causes of pending faults, the drive is automatically switched back on.
F07330	Search current measured too low	Increase the search current (p1202), check the motor connection.
A07400	DC-link voltage maximum controller active	If it is not desirable that the controller intervenes: <ul style="list-style-type: none"> <li>• Increase the ramp-down times.</li> <li>• Deactivate the Vdc_max control (p1240 = 0 for vector control, p1280 = 0 for V/f control).</li> </ul>
A07409	V/f control, current limiting controller active	The alarm automatically disappears after one of the following measures: <ul style="list-style-type: none"> <li>• Increase the current limit (p0640).</li> <li>• Reduce the load.</li> <li>• Slow down the ramp-ups for the setpoint speed.</li> </ul>
F07426	Technology controller actual value limited	<ul style="list-style-type: none"> <li>• Adapt the limits to the signal level (p2267, p2268).</li> <li>• Check the actual value scaling (p2264).</li> </ul>
A07444	PID autotuning is activated	Automatic setting of the PID controller (autotuning) is active (p2350 > 0). The alarm disappears automatically after completion of the autotuning.

Number	Cause	Remedy
F07445	PID autotuning canceled	The inverter has canceled the automatic setting of the PID controller (autotuning) because of a fault. Remedy: Increase p2355 and restart autotuning.
F07801	Motor overcurrent	Check the current limits (p0640). Vector control: Check the current controller (p1715, p1717). V/f control: Check the current limiting controller (p1340 ... p1346). Increase the acceleration ramp (p1120) or reduce the load. Check the motor and motor cables for short-circuit and ground fault. Check the motor regarding the star/delta connection and rating plate parameterization. Check the power unit / motor combination. Select the flying restart function (p1200) if switched to rotating motor.
A07805	Drive: Power unit overload I2t	<ul style="list-style-type: none"> <li>Reduce the continuous load.</li> <li>Adapt the load cycle.</li> <li>Check the assignment of rated currents of the motor and power unit.</li> </ul>
F07806	Regenerative power limit exceeded	Increase the deceleration ramp. Reduce the driving load. Use a power unit with higher energy recovery capability. For vector control, the regenerative power limit in p1531 can be reduced until the fault is no longer activated.
F07807	Short-circuit detected	<ul style="list-style-type: none"> <li>Check the inverter connection on the motor side for any phase-phase short-circuit.</li> <li>Rule out that line and motor cables have been interchanged.</li> </ul>
A07850 A07851 A07852	External alarm 1 ... 3	The signal for "external alarm 1" has been triggered. Parameters p2112, p2116 and p2117 determine the signal sources for the external alarm 1... 3. Remedy: Remove the causes of these alarms.
F07860 F07861 F07862	External fault 1 ... 3	Remove the external causes for these faults.
F07900	Motor blocked	Check that the motor can run freely. Check the torque limits (r1538 and r1539). Check the parameters of the "Motor blocked" message (p2175, p2177).
F07901	Motor overspeed	Activate the precontrol for the speed limiting controller (p1401 bit 7 = 1). Increase the hysteresis for overspeed signal p2162.
F07902	Motor stalled	Check whether the motor data has been set correctly and perform a motor identification. Check the current limits (p0640, r0067, r0289). If the current limits are too low, the drive cannot be magnetized. Check whether motor cables are disconnected during operation.
A07903	Motor speed deviation	Increase p2163 and/or p2166. Increase the torque, current and power limits.

9.5 List of alarms and faults

Number	Cause	Remedy
A07910	Motor overtemperature	Check the motor load. Check the motor's ambient temperature. Check the KTY84 or PT1000 sensor. Check the overtemperatures of the thermal model (p0626 ... p0628).
A07920	Torque/speed too low	The torque deviates from the torque/speed envelope curve. <ul style="list-style-type: none"> <li>• Check the connection between the motor and the load.</li> <li>• Adapt the parameterization corresponding to the load.</li> </ul>
A07921	Torque/speed too high	
A07922	Torque/speed out of tolerance	
F07923	Torque/speed too low	<ul style="list-style-type: none"> <li>• Check the connection between the motor and the load.</li> <li>• Adapt the parameterization corresponding to the load.</li> </ul>
F07924	Torque/speed too high	
A07927	DC braking active	Not required
A07980	Rotary measurement activated	Not required
A07981	No enabling for rotary measurement	Acknowledge pending faults. Establish missing enables (see r00002, r0046).
A07991	Motor identification activated	Switch on the motor and identify the motor data.
F08501	Setpoint timeout	<ul style="list-style-type: none"> <li>• Check the PROFINET connection.</li> <li>• Set the control into the RUN mode.</li> <li>• If the fault occurs repeatedly, check the monitoring time set p2044.</li> </ul>
F08502	Monitoring time, sign-of-life expired	<ul style="list-style-type: none"> <li>• Check the PROFINET connection.</li> </ul>
F08510	Send configuration data not valid	<ul style="list-style-type: none"> <li>• Check the PROFINET configuration</li> </ul>
A08511	Receive configuration data not valid	
A08526	No cyclic connection	<ul style="list-style-type: none"> <li>• Activate the control with cyclic operation.</li> <li>• Check the parameters "Name of Station" and "IP of Station" (r61000, r61001).</li> </ul>
A08565	Consistency error affecting adjustable parameters	Check the following: <ul style="list-style-type: none"> <li>• IP address, subnet mask or default gateway is not correct.</li> <li>• IP address or station name used twice in the network.</li> <li>• Station name contains invalid characters.</li> </ul>
F08700	Communications error	A CAN communications error has occurred. Check the following: <ul style="list-style-type: none"> <li>• Bus cable</li> <li>• Baud rate (p8622)</li> <li>• Bit timing (p8623)</li> <li>• Master</li> </ul> Start the CAN controller manually with p8608 = 1 after the cause of the fault has been resolved!
F13100	Know-how protection: Copy protection error	The know-how protection and the copy protection for the memory card are active. An error occurred when checking the memory card. <ul style="list-style-type: none"> <li>• Insert a suitable memory card and switch the inverter power supply temporarily off and then on again (POWER ON).</li> <li>• Deactivate the copy protection (p7765).</li> </ul>

Number	Cause	Remedy
F13101	Know-how protection: Copy protection cannot be activated	Insert a valid memory card.
F30001	Overcurrent	<p>Check the following:</p> <ul style="list-style-type: none"> <li>• Motor data, if required, carry out commissioning</li> <li>• Motor connection method (Y / <math>\Delta</math>)</li> <li>• V/f operation: Assignment of rated currents of motor and Power Module</li> <li>• Line quality</li> <li>• Make sure that the line commutating reactor is connected properly</li> <li>• Power cable connections</li> <li>• Power cables for short-circuit or ground fault</li> <li>• Power cable length</li> <li>• Line phases</li> </ul> <p>If this doesn't help:</p> <ul style="list-style-type: none"> <li>• V/f operation: Increase the acceleration ramp</li> <li>• Reduce the load</li> <li>• Replace the power unit</li> </ul>
F30002	DC-link voltage overvoltage	<p>Increase the ramp-down time (p1121).  Set the rounding times (p1130, p1136).  Activate the DC-link voltage controller (p1240, p1280).  Check the line voltage (p0210).  Check the line phases.</p>
F30003	DC-link voltage undervoltage	Check the line voltage (p0210).
F30004	Inverter overtemperature	<p>Check whether the inverter fan is running.  Check whether the ambient temperature is in the permissible range.  Check whether the motor is overloaded.  Reduce the pulse frequency.</p>
F30005	I <sub>2t</sub> inverter overload	<p>Check the rated currents of the motor and Power Module.  Reduce the current limit p0640.  When operating with V/f characteristic: Reduce p1341.</p>
F30011	Line phase failure	<p>Check the inverter's input fuses.  Check the motor feeder cables.</p>
F30015	Motor cable phase failure	<p>Check the motor cables.  Increase the ramp-up or ramp-down time (p1120).</p>
F30021	Ground fault	<ul style="list-style-type: none"> <li>• Check the power cable connections.</li> <li>• Check the motor.</li> <li>• Check the current transformer.</li> <li>• Check the cables and contacts of the brake connection (a wire might be broken).</li> </ul>
F30027	Time monitoring for DC-link pre-charging	<p>Check the line voltage at the input terminals.  Check the line voltage setting (p0210).</p>
F30035	Overtemperature, intake air	<ul style="list-style-type: none"> <li>• Check whether the fan is running.</li> </ul>

9.5 List of alarms and faults

Number	Cause	Remedy
F30036	Overtemperature, inside area	<ul style="list-style-type: none"> <li>• Check the fan filter elements.</li> <li>• Check whether the ambient temperature is in the permissible range.</li> </ul>
F30037	Rectifier overtemperature	See F30035 and, in addition: <ul style="list-style-type: none"> <li>• Check the motor load.</li> <li>• Check the line phases</li> </ul>
A30049	Internal fan defective	Check the internal fan and if required replace.
F30059	Internal fan defective	Check the internal fan and if required replace.
A30502	DC-link overvoltage	<ul style="list-style-type: none"> <li>• Check the unit supply voltage (p0210).</li> <li>• Check the dimensioning of the line reactor.</li> </ul>
A30920	Temperature sensor fault	Check that the sensor is connected correctly.
A50001	PROFINET configuration error	A PROFINET control is attempting to establish a connection with an incorrect configuration telegram. Check whether "Shared Device" is activated (p8929 = 2).
A50010	PROFINET name of station invalid	Correct the name of station (p8920) and activate (p8925 = 2).
A50020	PROFINET: Second control missing	"Shared Device" is activated (p8929 = 2). However, only the connection to a PROFINET control is available.
For further information, please refer to the List Manual.		

For further information, please refer to the List Manual.



Overview of the manuals (Page 507)



## 9.6 Identification & maintenance data (I&M)

### I&M data

The inverter supports the following identification and maintenance (I&M) data.

I&M data	Format	Explanation	Associated parameters	Example for the content
I&M0	u8[64] PROFIBUS u8[54] PROFINET	Inverter-specific data, read only	-	See below
I&M1	Visible String [32]	Plant/system identifier	p8806[0 ... 31]	"ak12- ne.bo2=fu1"
	Visible String [22]	Location code	p8806[32 ... 53]	"sc2+or45"
I&M2	Visible String [16]	Date	p8807[0 ... 15]	"2013-01-21 16:15"
I&M3	Visible String [54]	Any comment	p8808[0 ... 53]	-
I&M4	Octet String[54]	Check signature to track changes for Safety Integrated. This value can be changed by the user. The test signature is reset to the value generated by the machine is p8805 = 0 is used.	p8809[0 ... 53]	Values of r9781[0] and r9782[0]

When requested, the inverter transfers its I&M data to a higher-level control or to a PC/PG with installed STEP 7, STARTER or TIA-Portal.

### I&M0

Designation	Format	Example for the content	Valid for PROFINET	Valid for PROFIBUS
Manufacturer-specific	u8[10]	00 ... 00 hex	---	✓
MANUFACTURER_ID	u16	42d hex (=Siemens)	✓	✓
ORDER_ID	Visible String [20]	„6SL3246-0BA22-1FA0“	✓	✓
SERIAL_NUMBER	Visible String [16]	„T-R32015957“	✓	✓
HARDWARE_REVISION	u16	0001 hex	✓	✓
SOFTWARE_REVISION	char, u8[3]	„V“ 04.70.19	✓	✓
REVISION_COUNTER	u16	0000 hex	✓	✓
PROFILE_ID	u16	3A00 hex	✓	✓
PROFILE_SPECIFIC_TYPE	u16	0000 hex	✓	✓
IM_VERSION	u8[2]	01.02	✓	✓
IM_SUPPORTED	bit[16]	001E hex	✓	✓



## Technical data

### 10.1 Technical data, CU240B-2 Control Unit

Feature	Data
Fieldbus interface	<p>CU240B-2 With RS485 interface for the following protocols:</p> <ul style="list-style-type: none"> <li>• USS</li> <li>• Modbus RTU</li> </ul> <p>Article numbers:   Overview of Control Units (Page 29)</p> <hr/> <p>CU240B-2 DP With PROFIBUS interface</p>
Operating voltage	<p>You have two options for the Control Unit power supply:</p> <ul style="list-style-type: none"> <li>• Supply from the Power Module</li> <li>• External supply via terminals 31 and 32 with 20.4 ... 28.8 VDC. Use a power supply with protective extra low voltage (PELV according to EN 61800-5-1), Class 2. The 0 V of the power supply must be connected to the PE of the plant/system through a low-ohmic connection.</li> </ul> <hr/> <p>The power supply is electrically isolated from the control terminals.</p>
Current consumption	max 0.5 A
Power loss	5.0 W Plus power loss of the output voltages.
Output voltages	<p>+24 V out (terminal 9), 18 V ... 28.8 V, max. 100 mA</p> <hr/> <p>+10 V out (terminals 1 and 35), 9.5 V ... 10.5 V, max. 10 mA</p>
Setpoint resolution	0.01 Hz
Digital inputs	<p>4 (DI 0 ... DI 3)</p> <ul style="list-style-type: none"> <li>• Low &lt; 5 V, high &gt; 11 V</li> <li>• Electrically isolated</li> <li>• 30 V maximum input voltage</li> <li>• 5.5 mA current consumption</li> <li>• SIMATIC-compatible</li> <li>• PNP/NPN switchable</li> <li>• 10 ms response time for debounce time p0724 = 0.</li> </ul>
Analog input	<p>1 (AI 0)</p> <ul style="list-style-type: none"> <li>• Differential input</li> <li>• 12-bit resolution</li> <li>• 13 ms ± 1 ms response time</li> <li>• Switchable: <ul style="list-style-type: none"> <li>– 0 V ... 10 V or -10 V ... +10 V (voltage &lt; 35 V)</li> <li>– 0 mA ... 20 mA (120 Ω input resistance, voltage &lt; 10 V, current &lt; 80 mA)</li> </ul> </li> <li>• If AI 0 has been configured as additional digital input: Voltage &lt; 35 V, low &lt; 1.6 V, high &gt; 4.0 V, 13 ms ± 1 ms response time for debounce time p0724 = 0.</li> </ul>



Technical data

10.1 Technical data, CU240B-2 Control Unit

Feature	Data
Digital output	<p>1 (DO 0)</p> <ul style="list-style-type: none"> <li>Relay output, 30 V DC / max. 0.5 A for ohmic loads</li> <li>Update time 2 ms</li> </ul> <p>For applications which require UL certification, the voltage at DO 0 must not exceed 30 VDC referred to ground potential and must be supplied via a grounded class 2 power supply.</p>
Analog output	<p>1 (AO 0)</p> <ul style="list-style-type: none"> <li>0 V ... 10 V or 0 mA ... 20 mA</li> <li>Reference potential: "GND"</li> <li>16-bit resolution</li> <li>4 ms update time</li> </ul>
Temperature sensor	<p>PTC</p> <ul style="list-style-type: none"> <li>Short-circuit monitoring 22 Ω</li> <li>Switching threshold 1650 Ω</li> </ul> <hr/> <p>KTY84</p> <ul style="list-style-type: none"> <li>Short-circuit monitoring &lt; 50 Ω</li> <li>Wire-break &gt; 2120 Ω</li> </ul> <hr/> <p>PT1000</p> <ul style="list-style-type: none"> <li>Short-circuit monitoring &lt; 603 Ω</li> <li>Wire-break &gt; 2120 Ω</li> </ul> <p>Temperature switch with isolated contact.</p>
USB interface	Mini-B
Dimensions (WxHxD)	73 mm × 199 mm × 39 mm The depth specification is valid when mounting on the Power Module.
Weight	0.49 kg
Memory cards	<p>Slot for SD or MMC memory cards</p> <p> Overview of Control Units (Page 29)</p>
Operating temperature	<p>-10° C ... 55° C Without inserted Operator Panel</p> <p>0° C ... 50° C With inserted BOP-2 or IOP Operator Panel</p> <p>Observe any possible restrictions regarding the operating temperature as a result of the Power Module.</p>
Storage temperature	- 40° C ... 70° C
Relative humidity	< 95% Condensation is not permissible.

## 10.2 Technical data, CU240E-2 Control Unit

Feature	Data
Fieldbus interface	CU240E-2, CU240E-2 F With RS485 interface for the following protocols: <ul style="list-style-type: none"> <li>• USS</li> <li>• Modbus RTU</li> </ul>
	CU240E-2 DP, CU240E-2 DP-F With PROFIBUS interface
	CU240E-2 PN, CU240E-2 PN-F With PROFINET interface
Operating voltage	<p>You have two options for the Control Unit power supply:</p> <ul style="list-style-type: none"> <li>• Supply from the Power Module</li> <li>• External supply via terminals 31 and 32 with 20.4 ... 28.8 VDC. Use a power supply with protective extra low voltage (PELV according to EN 61800-5-1), Class 2. The 0 V of the power supply must be connected to the PE of the plant/system through a low-ohmic connection.</li> </ul> <p>The power supply is electrically isolated from the control terminals.</p>
Current consumption	max 0.5 A
Power loss	5.0 W Plus power loss of the output voltages.
Output voltages	+24 V out (terminal 9), 18 V ... 28.8 V, max. 100 mA
	+10 V out (terminals 1 and 35), 9.5 V ... 10.5 V, max. 10 mA
Setpoint resolution	0.01 Hz
Digital inputs	6 (DI 0 ... DI 5) <ul style="list-style-type: none"> <li>• Low &lt; 5 V, high &gt; 11 V</li> <li>• Electrically isolated</li> <li>• 30 V maximum input voltage</li> <li>• 5.5 mA current consumption</li> <li>• SIMATIC-compatible</li> <li>• PNP/NPN switchable</li> <li>• 10 ms response time for debounce time p0724 = 0.</li> </ul>
Pulse input	1 (DI 3) Maximum frequency 32 kHz
Analog inputs	2 (AI 0, AI 1) <ul style="list-style-type: none"> <li>• Differential input</li> <li>• 12-bit resolution</li> <li>• 13 ms ± 1 ms response time</li> <li>• AI 0 and AI 1 can be switched over: <ul style="list-style-type: none"> <li>– 0 V ... 10 V or -10 V ... +10 V (voltage &lt; 35 V)</li> <li>– 0 mA ... 20 mA (120 Ω input resistance, voltage &lt; 10 V, current &lt; 80 mA)</li> </ul> </li> <li>• If AI 0 and AI 1 are configured as supplementary digital inputs: Voltage &lt; 35 V, low &lt; 1.6 V, high &gt; 4.0 V, 13 ms ± 1 ms response time for debounce time p0724 = 0.</li> </ul>

Feature	Data
Digital outputs	<p>3 (DO 0 ... DO 2)</p> <ul style="list-style-type: none"> <li>• DO 0: Relay output, 30 VDC / max. 0.5 A with resistive load</li> <li>• DO 1: Transistor output, 30 VDC / max. 0.5 A with resistive load, protection against incorrect voltage polarity.</li> <li>• DO 2: Relay output, 30 VDC / max. 0.5 A with resistive load.</li> <li>• 2 ms update time</li> </ul> <p>For applications which require UL certification, the voltage at DO 0 must not exceed 30 VDC referred to ground potential and must be supplied via a grounded class 2 power supply.</p>
Analog outputs	<p>2 (AO 0, AO 1)</p> <ul style="list-style-type: none"> <li>• 0 V ... 10 V or 0 mA ... 20 mA</li> <li>• Reference potential: "GND"</li> <li>• 16-bit resolution</li> <li>• 4 ms update time</li> </ul>
Temperature sensor	<p>PTC</p> <ul style="list-style-type: none"> <li>• Short-circuit monitoring 22 Ω</li> <li>• Switching threshold 1650 Ω</li> </ul> <hr/> <p>KTY84</p> <ul style="list-style-type: none"> <li>• Short-circuit monitoring &lt; 50 Ω</li> <li>• Wire-break &gt; 2120 Ω</li> </ul> <hr/> <p>PT1000</p> <ul style="list-style-type: none"> <li>• Short-circuit monitoring &lt; 603 Ω</li> <li>• Wire-break &gt; 2120 Ω</li> </ul> <p>Temperature switch with isolated contact.</p>
Fail-safe digital input	<p>1 (DI 4 and DI 5)</p> <ul style="list-style-type: none"> <li>• If you have enabled the basic functions of the safety functions, DI 4 and DI 5 form the fail-safe digital input.</li> <li>• Maximum input voltage 30 V, 5.5 mA</li> <li>• Response time: <ul style="list-style-type: none"> <li>– Typical: 5 ms + debounce time p9651</li> <li>– Typical, if debounce time = 0: 6 ms</li> <li>– Worst-case scenario: 15 ms + debounce time</li> <li>– Worst case, if debounce time = 0: 16 ms</li> </ul> </li> </ul> <p>Extended safety function data be found in the "Safety Integrated" function manual.</p> <p> Overview of the manuals (Page 507)</p>
PFH	<p>5 × 10E-8</p> <p>Probability of failure of the safety functions (Probability of Failure per Hour)</p>
USB interface	Mini-B
Dimensions (WxHxD)	<p>73 mm × 199 mm × 39 mm</p> <p>The depth specification is valid when mounting on the Power Module.</p>
Weight	0.49 kg
Memory cards	<p>Slot for SD or MMC memory cards,</p> <p> Overview of Control Units (Page 29)</p>
Operating temperature	<p>-10° C ... 55° C</p> <p>CU240E-2, CU240E-2 F, CU240E-2 DP, CU240E-2 DP-F</p> <p>Without inserted Operator Panel</p> <hr/> <p>-10° C ... 53° C</p> <p>CU240E-2 PN, CU240E-2 PN-F</p> <p>Without inserted Operator Panel</p>

Feature	Data
	0° C ... 50° C      With inserted BOP-2 or IOP Operator Panel
	Observe any possible restrictions regarding the operating temperature as a result of the Power Module.
Storage temperature	- 40° C ... 70° C
Relative humidity	< 95%      Condensation is not permissible.

**Note**

**Short-term voltage dips in the external 24 V supply ( $\leq 3$  ms and  $\leq 95\%$  of the rated voltage)**

When the mains voltage of the inverter is switched off, the inverter responds to short-term voltage dips in the external 24 V supply with fault F30074. Communication via fieldbus, however, remains in effect in this case.

## 10.3 Technical data, Power Modules

Overload capability is the property of the inverter to temporarily supply a current that is higher than the rated current to accelerate a load. Two typical load cycles are defined to clearly demonstrate the overload capability: "Low Overload" and "High Overload"

### Definitions

#### Base load

Constant load between the accelerating phases of the drive

#### Low Overload

- **LO base load input current**  
Permissible input current for a "Low Overload" load cycle
- **LO base load output current**  
Permissible output current for a "Low Overload" load cycle
- **LO base load power**  
Rated power based on the LO base load output current

#### High Overload

- **HO base load input current**  
Permissible input current for a "High Overload" load cycle
- **HO base load output current**  
Permissible output current for a "High Overload" load cycle
- **HO base load power**  
Rated power based on the HO base load output current

If not specified otherwise, the power and current data in the technical data always refer to a load cycle according to Low Overload.

We recommend the "SIZER" engineering software to select the inverter.



You will find additional information about SIZER on the Internet: Download SIZER (<http://support.automation.siemens.com/WW/view/en/10804987/130000>).

### Load cycles and typical applications:

#### "Low Overload" load cycle

The "Low Overload" load cycle assumes a uniform base load with low requirements placed on brief accelerating phases. Typical applications when designing according to "Low Overload" include:

- Pumps, fans and compressors
- Wet or dry blasting technology
- Mills, mixers, kneaders, crushers, agitators
- Basic spindles
- Rotary kilns
- Extruders

#### "High Overload" load cycle

The "High Overload" load cycle permits, for reduced base load, dynamic accelerating phases. Typical applications when designing according to "High Overload" include:

- Horizontal and vertical conveyor technology (conveyor belts, roller conveyors, chain conveyors)
- Centrifuges
- Escalators/moving stairways
- Lifters/Lowerers
- Elevators
- Gantry cranes
- Cable railways
- Storage and retrieval machines



### 10.3.1 Technical data, PM240-2

#### 10.3.1.1 High overload - low overload PM240-2

#### Typical inverter load cycles

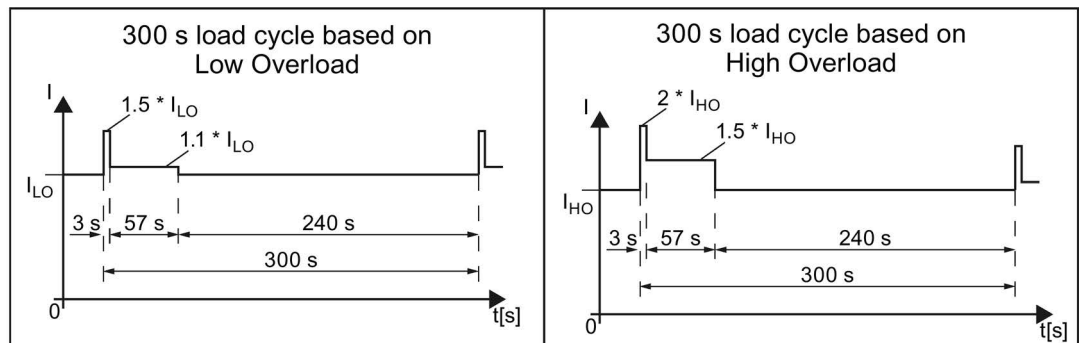





Image 10-1 "Low Overload" and "High Overload" load cycles

10.3.1.2 General data, PM240-2 - 200 V

Property	Version
Line voltage	FSA ... FSC 200 V ... 240 V 1-ph. AC $\pm 10\%$ for LO base load power 0.55 kW ... 4 kW for HO base load power 0.37 kW ... 3 kW
	200 V ... 240 V 3-ph. AC $\pm 10\%$ for LO base load power 0.55 kW ... 7.5 kW for HO base load power 0.37 kW ... 5.5 kW
	FSD ... FSF 200 V ... 240 V 3-ph. AC -20 % / + 10 %
Output voltage	3 AC 0 V ... 0.95 x input voltage (max.)
Input frequency	50 Hz ... 60 Hz, $\pm 3$ Hz
Output frequency	0 ... 550 Hz, depending on the control mode
Line impedance	FSA ... FSC $U_k \geq 2\%$ , for lower values, we recommend a line reactor, or a Power Module with the next higher power rating.
	FSD ... FSF Line reactor not required
Power factor $\lambda$	FSA ... FSC 0.7 without line reactor for $U_k \geq 2\%$ 0.85 with line reactor for $U_k < 2\%$
	FSD ... FSF 0.95 line reactor not required
Inrush current	< LO base load input current
Overvoltage category acc. to EN 60664-1	The inverter insulation is designed for surge voltages according to overvoltage Category III.
Pulse frequency	4 kHz (factory setting), Adjustable as follows in 2 kHz steps: • 4 kHz ... 16 kHz for devices from 0.55 kW ... 30 kW. • 4 kHz ... 8 kHz for devices 36 kW and higher
	If you increase the pulse frequency, the inverter reduces the maximum output current.
Short-circuit current rating (SCCR)	FSA ... FSC $\leq 100$ kA rms
	FSD ... FSF $\leq 65$ kA rms
	 Branch protection and short-circuit strength according to UL and IEC <a href="https://support.industry.siemens.com/cs/ww/en/view/109479152">https://support.industry.siemens.com/cs/ww/en/view/109479152</a>
Electromagnetic compatibility according to IEC/EN 61800-3	Devices with integrated filter are suitable for Category C2 environments.
Braking methods	DC braking, compound braking, dynamic braking with integrated braking chopper
Degree of protection according to EN 60529	Chassis devices IP20 Must be installed in a control cabinet
	PT devices IP20, IP54 Must be installed in a control cabinet at the control cabinet panel
Ambient temperature	FSA ... FSC:
	LO base load power without derating: -10 °C ... +40 °C
	HO base load power without derating: -10 °C ... +50 °C
	LO/HO base load power with derating: -10 °C ... + 60° C
	FSD ... FSF:
	LO base load power without derating: -20 °C ... +40 °C
HO base load power without derating: -20 °C ... +50 °C	
LO/HO base load power with derating: -20 °C ... + 60° C	
	 Restrictions for special ambient conditions (Page 475) For the maximum permissible ambient temperature, also observe the permissible ambient temperatures for the Control Unit and possibly operator panel (IOP or BOP-2) .

Property	Version	
Ambient conditions according to EN 60721-3-3	FSA ... FSC	Protected against damaging chemical substance, according to environmental Class 3C2
	FSD ... FSF	Protected against damaging chemical substance, according to environmental Class 3C3
Temperature during storage according to EN 60721-3-3	-40 °C ... +70 °C	
Cooling air	clean and dry air	
Relative humidity	< 95%	
Pollution according to EN 61800-5-1	suitable for environments with degree of pollution 2, condensation not permissible	
Shocks and vibration according to EN 60721-3-1	<ul style="list-style-type: none"> <li>• Long-term storage in the transport packaging according to Class 1M2</li> <li>• Transport in the transport packaging according to Class 2M3</li> <li>• Vibration in operation according to Class 3M2</li> </ul>	
Installation altitude	without derating	up to 1000 m above sea level
	with derating	up to 4000 m above sea level
	 Restrictions for special ambient conditions (Page 475)	
Approvals	FSA ... FSC	cULus, CE, C-tick, KCC
	FSD ... FSF	cULus, CE, C-tick, SEMI F47, KCC, WEEE, RoHS, EAC

### 10.3.1.3 Power-dependent data, PM240-2 - 200 V

The fuses listed in the following tables are examples of suitable fuses.

Additional components for branch protection:  Branch protection and short-circuit strength according to UL and IEC

(<https://support.industry.siemens.com/cs/ww/en/view/109479152>)

Table 10- 1 PM240-2, IP20, frame sizes A, 1 AC / 3 AC 200 V ... 240 V

Article No. - without filter	6SL3210...	...1PB13-0UL0	...1PB13-8UL0
Article No. - with filter	6SL3210...	...1PB13-0AL0	...1PB13-8AL0
LO base load power		0.55 kW	0.75 kW
LO base load input current 1 AC		7.5 A	9.6 A
LO base load input current 3 AC		4.2 A	5.5 A
LO base load output current		3.2 A	4.2 A
HO base load power		0.37 kW	0.55 kW
HO base load input current 1 AC		6.6 A	8.4 A
HO base load input current 3 AC		3.0 A	4.2 A
HO base load output current		2.3 A	3.2 A
Fuse according to IEC		3NA3 803 (10 A)	3NA3 805 (16 A)
Fuse according to UL		15 A Class J	15 A Class J
Power losses without filter		0.04 kW	0.04 kW
Power losses with filter		0.04 kW	0.04 kW
Required cooling air flow		5 l/s	5 l/s
Weight without filter		1.4 kg	1.4 kg
Weight with filter		1.6 kg	1.6 kg

Table 10- 2 PM240-2, PT, frame sizes A, 1 AC / 3 AC 200 V ... 240 V

Article No. - without filter	6SL3211...	...1PB13-8UL0
Article No. - with filter	6SL3211...	...1PB13-8AL0
LO base load power		0.75 kW
LO base load input current 1 AC		9.6 A
LO base load input current 3 AC		5.5 A
LO base load output current		4.2 A
HO base load power		0.55 kW
HO base load input current 1 AC		8.4 A
HO base load input current 3 AC		4.2 A
HO base load output current		3.2 A
Fuse according to IEC		3NA3 805 (16 A)
Fuse according to UL		15 A Class J
Power losses without filter		0.04 kW
Power losses with filter		0.04 kW
Required cooling air flow		5 l/s
Weight without filter		1.8 kg
Weight with filter		2.0 kg

Table 10- 3 PM240-2, IP20, frame sizes B, 1 AC / 3 AC 200 V ... 240 V

Article No. - without filter	6SL3210...	...1PB15-5UL0	...1PB17-4UL0	...1PB21-0UL0
Article No. - with filter	6SL3210...	...1PB15-5AL0	...1PB17-4AL0	...1PB21-0AL0
LO base load power		1.1 kW	1.5 kW	2.2 kW
LO base load input current 1 AC		13.5 A	18.1 A	24.0 A
LO base load input current 3 AC		7.8 A	9.7 A	13.6 A
LO base load output current		6 A	7.4 A	10.4 A
HO base load power		0.75 kW	1.1 kW	1.5 kW
HO base load input current 1 AC		11.8 A	15.8 A	20.9 A
HO base load input current 3 AC		5.5 A	7.8 A	9.7 A
HO base load output current		4.2 A	6 A	7.4 A
Fuse according to IEC		3NE 1814-0 (20 A)	3NE 1815-0 (25 A)	3NE 1803-0 (35 A)
Fuse according to UL		35 A Class J	35 A Class J	35 A Class J
Power losses without filter		0.05 kW	0.07 kW	0.12 kW
Power losses with filter		0.05 kW	0.07 kW	0.12 kW
Required cooling air flow		9.2 l/s	9.2 l/s	9.2 l/s
Weight without filter		2.8 kg	2.8 kg	2.8 kg
Weight with filter		3.1 kg	3.1 kg	3.1 kg

Table 10- 4 PM240-2, PT, frame sizes B, 1 AC / 3 AC 200 V ... 240 V

Article No. - without filter	6SL3211...	...1PB21-0UL0
Article No. - with filter	6SL3211...	...-1PB21-0AL0
LO base load power		2.2 kW
LO base load input current 1 AC		24.0 A
LO base load input current 3 AC		13.6 A
LO base load output current		10.4 A
HO base load power		1.5 kW
HO base load input current 1 AC		20.9 A
HO base load input current 3 AC		9.7 A
HO base load output current		7.4 A
Fuse according to IEC		3NE 1803-0 (35 A)
Fuse according to UL		35 A Class J
Power losses without filter		0.12 kW <sup>1)</sup>
Power losses with filter		0.12 kW <sup>1)</sup>
Required cooling air flow		9.2 l/s
Weight without filter		3.4 kg
Weight with filter		3.7 kg

1) approx. 0.08 through the heatsink

10.3 Technical data, Power Modules

Table 10- 5 PM240-2, IP 20, frame sizes C, 1 AC / 3 AC 200 V ... 240 V

<b>Article No. - without filter</b>	<b>6SL3210...</b>	<b>...1PB21-4UL0</b>	<b>...1PB21-8UL0</b>
<b>Article No. - with filter</b>	<b>6SL3210...</b>	<b>...1PB21-4AL0</b>	<b>...1PB21-8AL0</b>
LO base load power		3 kW	4 kW
LO base load input current 1 AC		35.9 A	43.0 A
LO base load input current 3 AC		17.7 A	22.8 A
LO base load output current		13.6 A	17.5 A
HO base load power		2.2 kW	3 kW
HO base load input current 1 AC		31.3 A	37.5 A
HO base load input current 3 AC		13.6 A	17.7 A
HO base load output current		10.4 A	13.6 A
Fuse according to IEC		3NE 1817-0 (50 A)	3NE 1818-0 (63 A)
Fuse according to UL		50 A Class J	50 A Class J
Power losses without filter		0.14 kW	0.18 kW
Power losses with filter		0.14 kW	0.18 kW
Required cooling air flow		18.5 l/s	18.5 l/s
Weight without filter		5.0 kg	5.0 kg
Weight with filter		5.2 kg	5.2 kg

Table 10- 6 PM240-2, PT, frame sizes C, 1 AC / 3 AC 200 V ... 240 V

<b>Article No. - without filter</b>	<b>6SL3211...</b>	<b>...1PB21-8UL0</b>
<b>Article No. - with filter</b>	<b>6SL3211...</b>	<b>...1PB21-8AL0</b>
LO base load power		4 kW
LO base load input current 1 AC		43.0 A
LO base load input current 3 AC		22.8 A
LO base load output current		17.5 A
HO base load power		3 kW
HO base load input current 1 AC		37.5 A
HO base load input current 3 AC		17.7 A
HO base load output current		13.6 A
Fuse according to IEC		3NE 1818-0 (63 A)
Fuse according to UL		50 A Class J
Power losses without filter		0.18 kW <sup>1)</sup>
Power losses with filter		0.18 kW <sup>1)</sup>
Required cooling air flow		18.5 l/s
Weight without filter		5.9 kg
Weight with filter		6.2 kg

1) approx. 0.09 through the heatsink

Table 10- 7 PM240-2, IP 20, frame sizes C, 3 AC 200 V ... 240 V

Article No. - without filter	6SL3210...	...1PC22-2UL0	...1PC22-8UL0
Article No. - with filter	6SL3210...	...1PC22-2AL0	...1PC22-8AL0
LO base load power		5.5 kW	7.5 kW
LO base load input current		28.6 A	36.4 A
LO base load output current		22.0 A	28.0 A
HO base load power		4 kW	5.5 kW
HO base load input current		22.8 A	28.6 A
HO base load output current		17.5 A	22.0 A
Fuse according to IEC		3NE 1802-0 (40 A)	3NE 1817-0 (50 A)
Fuse according to UL		50 A Class J	50 A Class J
Power losses without filter		0.2 kW	0.26 kW
Power losses with filter		0.2 kW	0.26 kW
Required cooling air flow		18.5 l/s	18.5 l/s
Weight without filter		5.0 kg	5.0 kg
Weight with filter		5.2 kg	5.2 kg

Table 10- 8 PM240-2, IP20, FSD, 3 AC 200 V ... 240 V

Article No. - without filter	6SL3210-...	...1PC24-2UL0	...1PC25-4UL0	...1PC26-8UL0
LO base load power		11 kW	15 kW	18.5 kW
LO base load input current		40 A	51 A	64 A
LO base load output current		42 A	54 A	68 A
HO base load power		7.5 kW	11 kW	15 kW
HO base load input current		36 A	43 A	56 A
HO base load output current		35 A	42 A	54 A
Siemens fuse according to IEC/UL		3NE1818-0 / 63A	3NE1 820-0 / 80A	3NE1 021-0 / 100A
Fuse according to IEC/UL, Class J		60 A	70 A	90 A
Power loss		0.42 kW	0.57 kW	0.76 kW
Required cooling air flow		55 l/s	55 l/s	55 l/s
Weight		17 kg	17 kg	17 kg

Technical data

10.3 Technical data, Power Modules

Table 10- 9 PM240-2, IP20, FSE, 3 AC 200 V ... 240 V

Article No. - without filter	6SL3210-...	...1PC28-8UL0	...1PC31-1UL0
LO base load power		22 kW	30 kW
LO base load input current		76 A	98 A
LO base load output current		80 A	104 A
HO base load power		18.5 kW	22 kW
HO base load input current		71 A	83 A
HO base load output current		68 A	80 A
Siemens fuse according to IEC/UL		3 NE1 021-0 / 100A	3 NE1 224-0 / 160A
Fuse according to IEC/UL, Class J		100 A	150 A
Power loss		0.85 kW	1.20 kW
Required cooling air flow		83 l/s	83 l/s
Weight		26 kg	26 kg

Table 10- 10 PM240-2, IP20, FSF, 3 AC 200 V ... 240 V



Article No. - without filter	6SL3210-...	...1PC31-3UL0	...1PC31-6UL0	...1PC31-8UL0
LO base load power		37 kW	45 kW	55 kW
LO base load input current		126 A	149 A	172 A
LO base load output current		130 A	154 A	178 A
HO base load power		30 kW	37 kW	45 kW
HO base load input current		110 A	138 A	164 A
HO base load output current		104 A	130 A	154 A
Siemens fuse according to IEC/UL		3 NE1 225-0 / 200A	3 NE1 225 -0 / 200A	3 NE1 227-0 / 250A
Fuse according to IEC/UL, Class J		175 A	200 A	225 A
Power loss		1.44 kW	1.79 kW	2.18 kW
Required cooling air flow		153 l/s	153 l/s	153 l/s
Weight		57 kg	57 kg	57 kg



Article number	LO base load output current for a pulse frequency of ... [A]						
	2 kHz / 4 kHz	6 kHz	8 kHz	10 kHz	12 kHz	14 kHz	16 kHz
6SL3210-1PB13-0□L0	<b>3.2</b>	2.6	2.1	1.8	1.5	1.4	1.2
6SL321□-1PB13-8□L0	<b>4.2</b>	3.3	2.7	2.3	2.0	1.8	1.6
6SL3211-1PB15-5□L0	<b>6.0</b>	4.7	3.9	3.3	2.8	2.5	2.2
6SL3210-1PB17-4□L0	<b>7.4</b>	6.3	5.2	4.4	3.7	3.3	3.0
6SL321□-1PB21-0□L0	<b>10.4</b>	8.8	7.3	6.2	5.2	4.7	4.2
6SL3210-1PB21-4□L0	<b>13.6</b>	11.6	9.5	8.2	6.8	6.1	5.4
6SL321□-1PB21-8□L0	<b>17.5</b>	14.9	12.3	10.5	8.8	7.9	7.0
6SL3210-1PC22-2□L0	<b>22.0</b>	18.7	15.4	13.2	11.0	9.9	8.8
6SL3210-1PC22-8□L0	<b>28.0</b>	23.8	19.6	16.8	14.0	12.6	11.2
6SL3210-1PC24-2□L0	<b>42</b>	35.7	29.4	25.2	21.0	18.9	16.8
6SL3210-1PC25-4□L0	<b>54</b>	45.9	37.8	32.4	27.0	24.3	21.6
6SL3210-1PC26-8□L0	<b>68</b>	57.8	47.6	40.8	34.0	30.6	27.2
6SL3210-1PC28-8□L0	<b>80</b>	68.0	56.0	48.0	40.0	36.0	32.0
6SL3210-1PC31-1□L0	<b>104</b>	88.4	72.8	62.4	52.0	46.8	41.6
6SL3210-1PC31-3□L0	<b>130</b>	110.5	91.0	---	---	---	---
6SL3210-1PC31-6□L0	<b>154</b>	130.9	107.8	---	---	---	---
6SL3210-1PC31-8□L0	<b>178</b>	151.3	124.6	---	---	---	---

The permissible motor cable length depends on the particular cable type and the pulse frequency that has been selected

10.3.1.4 General data, PM240-2 - 400 V

Property	Version
Line voltage	FSA ... FSC 380 V ... 480 V 3-ph. AC $\pm$ 10 %
	FSD ... FSF 3 AC 380 V ... 480 V -20 %, +10 %
Output voltage	3 AC 0 V ... 0.95 x input voltage (max.)
Input frequency	50 Hz ... 60 Hz, $\pm$ 3 Hz
Output frequency	0 ... 550 Hz, depending on the control mode
Line impedance	FSA ... FSC $U_k \geq 1\%$ , for lower values, we recommend a line reactor, or a Power Module with the next higher power rating.
	FSD ... FSF Line reactor not required
Power factor $\lambda$	FSA ... FSC 0.7 without line reactor for $U_k \geq 1\%$ 0.85 with line reactor for $U_k < 1\%$
	FSD ... FSF 0.95 line reactor not required
Inrush current	< LO base load input current
Overvoltage category acc. to EN 60664-1	The inverter insulation is designed for surge voltages according to overvoltage Category III.
Pulse frequency	Factory setting
	<ul style="list-style-type: none"> <li>4 kHz for devices with an LO base load power &lt; 75 kW</li> <li>2 kHz for devices with an LO base load power <math>\geq</math> 75 kW</li> </ul> Can be adjusted in 2 kHz steps as follows: <ul style="list-style-type: none"> <li>2 kHz ... 16 kHz for devices with an LO base load power &lt; 55 kW</li> <li>2 kHz ... 8 kHz for devices with an LO base load power <math>\geq</math> 55 kW</li> </ul> If you increase the pulse frequency, the inverter reduces the maximum output current.
Short-circuit current rating (SCCR)	FSA ... FSC $\leq$ 100 kA rms
	FSD ... FSF $\leq$ 65 kA rms
	 Branch protection and short-circuit strength according to UL and IEC ( <a href="https://support.industry.siemens.com/cs/ww/en/view/109479152">https://support.industry.siemens.com/cs/ww/en/view/109479152</a> )
Electromagnetic compatibility according to IEC/EN 61800-3	Devices with integrated filter are suitable for Category C2 environments.
Braking methods	DC braking, compound braking, dynamic braking with integrated braking chopper
Degree of protection according to EN 60529	Chassis devices IP20 Must be installed in a control cabinet
	IP20, Must be installed in a control cabinet
	PT devices IP54 at the control cabinet panel
Ambient temperature	FSA ... FSC:
	LO base load power without derating: -10 °C ... +40 °C
	HO base load power without derating: -10 °C ... +50 °C
	LO/HO base load power with derating: -10 °C ... + 60° C
	FSD ... FSF:
	LO base load power without derating: -20 °C ... +40 °C
HO base load power without derating: -20 °C ... +50 °C	
LO/HO base load power with derating: -20 °C ... + 60° C	
	 Power-dependent data, PM240-2 - 600 V (Page 448)
	For the maximum permissible ambient temperature, also observe the permissible ambient temperatures for the Control Unit and possibly operator panel (IOP or BOP-2) .

Property	Version
Ambient conditions according to EN 60721-3-3	FSA ... FSC: Protected against damaging chemical substance, according to environmental Class 3C2
	FSD ... FSF Protected against damaging chemical substance, according to environmental Class 3C3
Temperature during storage according to EN 60721-3-3	-40 °C ... +70 °C
Cooling air	clean and dry air
Relative humidity	< 95%
Pollution according to EN 61800-5-1	suitable for environments with degree of pollution 2, condensation not permissible
Shocks and vibration according to EN 60721-3-1	<ul style="list-style-type: none"> <li>• Long-term storage in the transport packaging according to Class 1M2</li> <li>• Transport in the transport packaging according to Class 2M3</li> <li>• Vibration in operation according to Class 3M2</li> </ul>
Installation altitude	without derating: up to 1000 m above sea level
	with derating: up to 4000 m above sea level
	 Restrictions for special ambient conditions (Page 475)
Approvals	FSA ... FSC cULus, CE, C-tick, KCC
	FSD ... FSF cULus, CE, C-tick, SEMI F47, KCC, WEEE, RoHS, EAC

### 10.3.1.5 Power-dependent data, PM240-2 - 400 V

The fuses listed in the following tables are examples of suitable fuses.

Additional components for branch protection:  Branch protection and short-circuit strength according to UL and IEC

(<https://support.industry.siemens.com/cs/ww/en/view/109479152>)

Table 10- 11 PM240-2, IP20, frame sizes A, 3-phase 380 ... 480 VAC

Article no. - without filter	6SL3210...	...1PE11-8UL1	...1PE12-3UL1	...1PE13-2UL1
Article no. - with filter	6SL3210...	...1PE11-8AL1	...1PE12-3AL1	...1PE13-2AL1
LO base load power		0.55 kW	0.75 kW	1.1 kW
LO base load input current		2.3 A	2.9 A	4.1 A
LO base load output current		1.7 A	2.2 A	3.1 A
HO base load power		0.37 kW	0.55 kW	0.75 kW
HO base load input current		2.0 A	2.6 A	3.3 A
HO base load output current		1.3 A	1.7 A	2.2 A
Fuse according to IEC		3NA3 804 (4 A)	3NA3 804 (4 A)	3NA3 801 (6 A)
Fuse according to UL		10 A Class J	10 A Class J	15 A Class J
Power loss		0.04 kW	0.04 kW	0.04 kW
Required cooling air flow		5 l/s	5 l/s	5 l/s
Weight without filter		1.3 kg	1.3 kg	1.3 kg
Weight with filter		1.5 kg	1.5 kg	1.5 kg

Table 10- 12 PM240-2, IP20, frame sizes A, 3-phase 380 ... 480 VAC

Article no. - without filter	6SL3210...	...1PE14-3UL1	...1PE16-1UL1	...1PE18-0UL1
Article no. - with filter	6SL3210...	...1PE14-3AL1	...1PE16-1AL1	...1PE18-0AL1
LO base load power		1.5 kW	2.2 kW	3.0 kW
LO base load input current		5.5 A	7.7 A	10.1 A
LO base load output current		4.1 A	5.9 A	7.7 A
HO base load power		1.1 kW	1.5 kW	2.2 kW
HO base load input current		4.7 A	6.1 A	8.8 A
HO base load output current		3.1 A	4.1 A	5.9 A
Fuse according to IEC		3NA3 803 (10 A)	3NA3 803 (10 A)	3NA3 805 (16 A)
Fuse according to UL		20 A Class J	30 A Class J	30 A Class J
Power loss		0.07 kW	0.1 kW	0.12 kW
Required cooling air flow		5 l/s	5 l/s	5 l/s
Weight without filter		1.4 kg	1.4 kg	1.4 kg
Weight with filter		1.6 kg	1.6 kg	1.6 kg

Table 10- 13 PM240-2, PT, frame sizes A, 3-phase 380 ... 480 VAC

<b>Article no. - without filter</b>	<b>6SL3211...</b>	<b>...1PE18-0UL1</b>
<b>Article no. - with filter</b>	<b>6SL3211...</b>	<b>...1PE18-0AL1</b>
LO base load power		3.0 kW
LO base load input current		10.1 A
LO base load output current		7.7 A
HO base load power		2.2 kW
HO base load input current		8.8 A
HO base load output current		5.9 A
Fuse according to IEC		3NA3 805 (16 A)
Fuse according to UL		30 A Class J
Power loss without filter		0.12 kW <sup>1)</sup>
Required cooling air flow		7 l/s
Weight without filter		1.8 kg
Weight with filter		2.0 kg

1) approx. 0.1 kW through the heatsink

Table 10- 14 PM240-2, IP20, frame sizes B, 3-phase 380 ... 480 VAC

<b>Article no. - without filter</b>	<b>6SL3210...</b>	<b>...1PE21-1UL0</b>	<b>...1PE21-4UL0</b>	<b>...1PE21-8UL0</b>
<b>Article no. - with filter</b>	<b>6SL3210...</b>	<b>...1PE21-1AL0</b>	<b>...1PE21-4AL0</b>	<b>...1PE21-8AL0</b>
LO base load power		4.0 kW	5.5 kW	7.5 kW
LO base load input current		13.3 A	17.2 A	22.2 A
LO base load output current		10.2 A	13.2 A	18.0 A
HO base load power		3.0 kW	4.0 kW	5.5 kW
HO base load input current		11.6 A	15.3 A	19.8 A
HO base load output current		7.7 A	10.2 A	13.2 A
Fuse according to IEC		3NE 1814-0 (20 A)	3NE 1815-0 (25 A)	3NE 1803-0 (35 A)
Fuse according to UL		35 A Class J	35 A Class J	35 A Class J
Power loss		0.11 kW	0.15 kW	0.2 kW
Required cooling air flow		9.2 l/s	9.2 l/s	9.2 l/s
Weight without filter		2.9 kg	2.9 kg	3.0 kg
Weight with filter		3.1 kg	3.1 kg	3.2 kg

Technical data

10.3 Technical data, Power Modules

Table 10- 15 PM240-2, PT, frame sizes B, 3-phase 380 ... 480 VAC

Article no. - without filter	6SL3211...	...1PE21-8UL0
Article no. - with filter	6SL3211...	...1PE21-8AL0
LO base load power		7.5 kW
LO base load input current		22.2 A
LO base load output current		18.0 A
HO base load power		5.5 kW
HO base load input current		19.8 A
HO base load output current		13.7 A
Fuse according to IEC		3NE 1803-0 (35 A)
Fuse according to UL		35 A Class J
Power loss		0.2 kW <sup>1)</sup>
Required cooling air flow		9.2 l/s
Weight without filter		3.6 kg
Weight with filter		3.9 kg

1) approx. 0.16 kW through the heatsink;

Table 10- 16 PM240-2, IP20, frame sizes C, 3-phase 380 ... 480 VAC

Article no. - without filter	6SL3210...	...1PE22-7UL0	...1PE23-3UL0
Article no. - with filter	6SL3210...	...1PE22-7AL0	...1PE23-3AL0
LO base load power		11.0 kW	15.0 kW
LO base load input current		32.6 A	39.9 A
LO base load output current		26.0 A	32.0 A
HO base load power		7.5 kW	11.0 kW
HO base load input current		27.0 A	36.0 A
HO base load output current		18.0 A	26.0 A
Fuse according to IEC		3NE 1817-0 (50 A)	3NE 1817-0 (50 A)
Fuse according to UL		50 A Class J	50 A Class J
Power loss		0.3 kW	0.37 kW
Required cooling air flow		18.5 l/s	18.5 l/s
Weight without filter		4.7 kg	4.8 kg
Weight with filter		5.3 kg	5.4 kg

Table 10- 17 PM240-2, PT, frame sizes C, 3-phase 380 ... 480 VAC

Article no. - without filter	6SL3211...	...1PE23-3UL0
Article no. - with filter	6SL3211...	...1PE23-3AL0
LO base load power		15.0 kW
LO base load input current		39.9 A
LO base load output current		32.0 A
HO base load power		11.0 kW
HO base load input current		36.0 A
HO base load output current		26.0 A
Fuse according to IEC		3NE 1817-0 (50 A)
Fuse according to UL		50 A Class J
Power loss		0.37 kW <sup>1)</sup>
Required cooling air flow		18.5 l/s
Weight without filter		5.8 kg
Weight with filter		6.3 kg

1) approx. 0.3 kW through the heatsink;

Table 10- 18 PM240-2, IP20, FSD, 3 AC 380 V ... 480 V

Article No. - without filter	6SL3210-...	...1PE23-8UL0	...1PE24-5UL0	...1PE26-0UL0
Article No. - with filter	6SL3210-...	...1PE23-8AL0	...1PE24-5AL0	...1PE26-0AL0
LO base load power		18.5 kW	22 kW	30 kW
LO base load input current		36 A	42 A	57 A
LO base load output current		38 A	45 A	60 A
HO base load power		15 kW	18.5 kW	22 kW
HO base load input current		33 A	38 A	47 A
HO base load output current		32 A	38 A	45 A
Siemens fuse according to IEC/UL		3NE1 818-0 / 63 A	3NE1 820-0 / 80 A	3NE1 021-0 / 100A
Fuse according to IEC/UL, Class J		60 A	70 A	90 A
Power loss without filter		0.55 kW	0.68 kW	0.76 kW
Power loss with filter		0.56 kW	0.68 kW	0.77 kW
Required cooling air flow		55 l/s	55 l/s	55 l/s
Weight without filter		16 kg	16 kg	17 kg
Weight with filter		17.5 kg	17.5 kg	18.5 kg

10.3 Technical data, Power Modules

Table 10- 19 PM240-2, IP20, FSD, 3 AC 380 V ... 480 V

Article No. - without filter	6SL3210-...	...1PE27-5UL0
Article No. - with filter	6SL3210-...	...1PE27-5AL0
LO base load power		37 kW
LO base load input current		70 A
LO base load output current		75 A
HO base load power		30 kW
HO base load input current		62 A
HO base load output current		60 A
Siemens fuse according to IEC/UL	3NE1 021-0 / 100 A	
Fuse according to IEC/UL, Class J	100 A	
Power loss without filter		1.01 kW
Power loss with filter		1.02 kW
Required cooling air flow		55 l/s
Weight without filter		17 kg
Weight with filter		18.5 kg

Table 10- 20 PM240-2, IP20, FSE, 3 AC 380 V ... 480 V

Article No. - without filter	6SL3210-...	...1PE28-8UL0	...1PE31-1UL0
Article No. - with filter	6SL3210-...	...1PE28-8AL0	...1PE31-1AL0
LO base load power		45 kW	55 kW
LO base load input current		86 A	104 A
LO base load output current		90 A	110 A
HO base load power		37 kW	45 kW
HO base load input current		78 A	94 A
HO base load output current		75 A	90 A
Siemens fuse according to IEC/UL	3NE1 022-0 / 125A	3NE1 224-0 / 160A	
Fuse according to IEC/UL, Class J	125 A	150 A	
Power losses without filter		1.19 kW	1.54 kW
Power losses with filter		1.2 kW	1.55 kW
Required cooling air flow		83 l/s	83 l/s
Weight without filter		26kg	26 kg
Weight with filter		28 kg	28 kg



Table 10- 21 PM240-2, IP20, FSF, 3 AC 380 V ... 480 V

Article No. - without filter	6SL3210-...	...1PE31-5UL0	...1PE31-8UL0	...1PE32-1UL0
Article No. - with filter	6SL3210-...	...1PE31-5AL0	...1PE31-8AL0	...1PE32-1AL0
LO base load power		75 kW	90 kW	110 kW
LO base load input current		140 A	172 A	198 A
LO base load output current		145 A	178 A	205 A
HO base load power		55 kW	75 kW	90 kW
HO base load input current		117 A	154	189 A
HO base load output current		110 A	145 A	178 A
Siemens fuse according to IEC/UL		3NE1 225-0 / 200 A	3NE1 227-0 / 250 A	3NE1 230-0 / 315 A
Fuse according to IEC/UL, Class J		200 A	250 A	300 A
Power loss without filter		1.95 kW	2.54 kW	2.36 kW
Power loss with filter		1.97 kW	2.56 kW	2.38 kW
Required cooling air flow		153 l/s	153 l/s	153 l/s
Weight without filter		57 kg	57 kg	61 kg
Weight with filter		63 kg	63 kg	65 kg



Table 10- 22 PM240-2, IP20, FSF, 3 AC 380 V ... 480 V

Article No. - without filter	6SL3210-...	...1PE32-5UL0
Article No. - with filter	6SL3210-...	...1PE32-5AL0
LO base load power		132 kW
LO base load input current		242 A
LO base load output current		250 A
HO base load power		110 kW
HO base load input current		218 A
HO base load output current		205 A
Siemens fuse according to IEC/UL		3NE1 331-0 / 350 A
Fuse according to IEC/UL, Class J		350 A
Power loss without filter		3.09 kW
Power loss with filter		3.12 kW
Required cooling air flow		153 l/s
Weight without filter		61 kg
Weight with filter		65 kg

Article number	LO base load output current for a pulse frequency of ... [A]						
	2 KHz / 4 kHz	6 kHz	8 kHz	10 kHz	12 kHz	14 kHz	16 kHz
6SL3210-1PE11-8□L1	<b>1.7</b>	1.4	1.2	1	0.9	0.8	0.7
6SL3210-1PE12-3□L1	<b>2.2</b>	1,9	1.5	1.3	1.1	1	0.9
6SL3211-1PE13-2□L1	<b>3.1</b>	2.6	2.2	1,9	1.6	1.4	1.2
6SL3210-1PE14-3□L1	<b>4.1</b>	3.5	2.9	2.5	2.1	1.8	1.6
6SL3210-1PE16-1□L1	<b>5.9</b>	5	4.1	3.5	3	2.7	2.4
6SL321□-1PE18-0□L1	<b>7.7</b>	6.5	5.4	4.6	3.9	3.5	3.1
6SL3210-1PE21-1□L0	<b>10.2</b>	8.7	7.1	6.1	5.1	4.6	4.1
6SL3210-1PE21-4□L0	<b>13.2</b>	11.2	9.2	7.9	6.6	5.9	5.3
6SL321□-1PE21-8□L0	<b>18</b>	15.3	12.6	10.8	9	8.1	7.2
6SL3210-1PE22-7□L0	<b>26</b>	22.1	18.2	15.6	13	11.7	10.4
6SL321□-1PE23-3□L0	<b>32</b>	27.2	22.4	19.2	16	14.4	12.8
6SL3210-1PE23-8□L0	<b>38</b>	32.3	26.6	22.8	19	17.1	15.2
6SL3210-1PE24-5□L0	<b>45</b>	38.3	31.5	27	22.5	20.3	18
6SL3210-1PE26-0□L0	<b>60</b>	51	42	36	30	27	24
6SL3210-1PE27-5□L0	<b>75</b>	63.8	52.5	45	37.5	33.8	30
6SL3210-1PE28-8□L0	<b>90</b>	76.5	63	54	45	40.5	36
6SL3210-1PE31-1□L0	<b>110</b>	93.5	77	66	55	49.5	44
6SL3210-1PE31-5□L0	<b>145</b>	123.25	108.75	---	---	---	---
6SL3210-1PE31-8□L0	<b>178</b>	151.3	133.5	---	---	---	---
6SL3210-1PE32-1□L0	<b>205</b>	---	---	---	---	---	---
6SL3210-1PE32-5□L0	<b>250</b>	---	---	---	---	---	---

The permissible motor cable length depends on the particular cable type and the pulse frequency that has been selected

### 10.3.1.6 General data, PM240-2 - 600 V

Property	Version
Line voltage	3 AC 500 V ... 690 V - 20 % ... +10 % (with fuses, Class J maximum 600 V)
Output voltage	3 AC 0 V ... 0.95 × input voltage (max.)
Input frequency	50 Hz ... 60 Hz, ± 3 Hz
Output frequency	0 ... 550 Hz, depending on the control mode
Power factor λ	> 0.9 line reactor not required
Inrush current	< LO base load input current
Overvoltage category acc. to EN 60664-1	The inverter insulation is designed for surge voltages according to overvoltage Category III.
Pulse frequency	2 kHz (factory setting), can be adjusted to 4 kHz If you increase the pulse frequency, the inverter reduces the maximum output current.
Short-circuit current rating (SCCR)	≤ 65 kA rms  Branch protection and short-circuit strength according to UL and IEC ( <a href="https://support.industry.siemens.com/cs/ww/en/view/109479152">https://support.industry.siemens.com/cs/ww/en/view/109479152</a> )
Electromagnetic compatibility according to IEC/EN 61800-3	Devices with integrated filter are suitable for Category C2 environments.
Braking methods	DC braking, compound braking, dynamic braking with integrated braking chopper
Degree of protection according to EN 60529	IP20; must be installed in a control cabinet
Ambient temperature	LO base load power without derating: -20 °C ... +40 °C HO base load power without derating: -20 °C ... +50 °C LO/HO base load power with derating: -20 °C ... +60 °C  Restrictions for special ambient conditions (Page 475) For the maximum permissible ambient temperature, also observe the permissible ambient temperatures for the Control Unit and possibly operator panel (IOP or BOP-2) .
Ambient conditions according to EN 60721-3-3	Protected against damaging chemical substance, according to environmental Class 3C3
Temperature during storage according to EN 60721-3-3	-40 °C ... +70 °C
Cooling air	clean and dry air
Relative humidity	< 95%
Pollution according to EN 61800-5-1	suitable for environments with degree of pollution 2, condensation not permissible
Shocks and vibration according to EN 60721-3-1	<ul style="list-style-type: none"> <li>• Long-term storage in the transport packaging according to Class 1M2</li> <li>• Transport in the transport packaging according to Class 2M3</li> <li>• Vibration in operation according to Class 3M2</li> </ul>
Installation altitude	without derating: up to 1000 m above sea level with derating: up to 4000 m above sea level  Restrictions for special ambient conditions (Page 475)
Approvals	cULus, CE, C-tick, SEMI F47, KCC, WEEE, RoHS, EAC

### 10.3.1.7 Power-dependent data, PM240-2 - 600 V

The fuses listed in the following tables are examples of suitable fuses.

Additional components for branch protection:  Branch protection and short-circuit strength according to UL and IEC

(<https://support.industry.siemens.com/cs/ww/en/view/109479152>)

Table 10- 23 PM240-2, IP20, FSD, 3 AC 500 V ... 690 V

Article No. - without filter	6SL3210-...	...1PH21-4UL0	...1PH22-0UL0	...1PH22-3UL0
Article No. - with filter	6SL3210-...	...1PH21-4AL0	...1PH22 -0AL0	...1PH22 -3AL0
LO base load power		11 kW	15 kW	18.5 kW
LO base load input current		14 A	18 A	22 A
LO base load output current		14 A	19 A	23 A
HO base load power		7.5 kW	11 kW	15 kW
HO base load input current		11 A	14 A	20 A
HO base load output current		11 A	14 A	19 A
Siemens fuse according to IEC/UL		3NE1 815-0 / 25 A	3NE1 815-0 / 25 A	3NE1 803-0 / 35 A
Fuse according to IEC/UL, Class J		20 A	25 A	30 A
Power loss without filter		0.32 kW	0.41 kW	0.48 kW
Power loss with filter		0.32 kW	0.41 kW	0.48 kW
Required cooling air flow		55 l/s	55 l/s	55 l/s
Weight without filter		17 kg	17 kg	17 kg
Weight with filter		18.5 kg	18.5 kg	18.5 kg

Table 10- 24 PM240-2, IP20, FSD, 3 AC 500 V ... 690 V

Article No. - without filter	6SL3210-...	...1PH22-7UL0	...1PH23-5UL0	...1PH24-2UL0
Article No. - with filter	6SL3210-...	...1PH22 -7AL0	...1PH23 -5AL0	...1PH24 -2AL0
LO base load power		22 kW	30 kW	37 kW
LO base load input current		25 A	33 A	40 A
LO base load output current		27A	35 A	42 A
HO base load power		18.5 kW	22 kW	30 kW
HO base load input current		24 A	28 A	36 A
HO base load output current		23 A	27 A	35 A
Siemens fuse according to IEC/UL		3NE1 803-0 / 35 A	3NE1 817-0 / 50 A	3NE1 818-0 / 63 A
Fuse according to IEC/UL, Class J		35 A	45 A	60 A
Power loss without filter		0.56 kW	0.72 kW	0.88kW
Power loss with filter		0.56 kW	0.73kW	0.88 kW
Required cooling air flow		55 l/s	55 l/s	55 l/s
Weight without filter		17 kg	17 kg	17 kg
Weight with filter		18.5 kg	18.5 kg	18.5 kg

Table 10- 25 PM240-2, IP20, FSE, 3 AC 500 V ... 690 V

Article No. - without filter	6SL3210-...	...1PH25-2UL0	...1PH26-2UL0
Article No. - with filter	6SL3210-...	...1PH25-2AL0	...1PH26 -2AL0
LO base load power		45 kW	55 kW
LO base load input current		50 A	59 A
LO base load output current		52 A	62A
HO base load power		37 kW	45 kW
HO base load input current		44 A	54 A
HO base load output current		42 A	52 A
Siemens fuse according to IEC/UL		3NA1 820-0 / 80A	3NE1 820-0 / 80A
Fuse according to IEC/UL, Class J		80 A	80 A
Power loss without filter		1.00 kW	1.21 kW
Power loss with filter		1.00 kW	1.22 kW
Required cooling air flow		83 l/s	83 l/s
Weight without filter		26 kg	26 kg
Weight with filter		28 kg	28 kg

Table 10- 26 PM240-2, IP20, FSF, 3 AC 500 V ... 690 V

Article No. - without filter	6SL3210-...	...1PH28-0UL0	...1PH31-0UL0	...1PH31-2UL0
Article No. - with filter	6SL3210-...	...1PH28-0AL0	...1PH31-0AL0	...1PH31-2AL0
LO base load power		75 kW	90 kW	110 kW
LO base load input current		78 A	97 A	111 A
LO base load output current		80 A	100 A	115 A
HO base load power		55 kW	75 kW	90 kW
HO base load input current		66 A	85 A	106 A
HO base load output current		62 A	80 A	100 A
Siemens fuse according to IEC/UL		3NE1 021-0 / 100 A	3NE1 022-0 / 125 A	3NE1 224-0 / 160 A
Fuse according to IEC/UL, Class J		100 A	125 A	150 A
Power loss without filter		1.34 kW	1.71 kW	2 kW
Power loss with filter		1.35 kW	1.72 kW	2.02 kW
Required cooling air flow		153 l/s	153 l/s	153 l/s
Weight without filter		60 kg	60 kg	60 kg
Weight with filter		64 kg	64 kg	64 kg

Table 10- 27 PM240-2, IP20, FSF, 3 AC 500 V ... 690 V

<b>Article No. - without filter</b>	<b>6SL3210-... ..1PH31-4UL0</b>
<b>Article No. - with filter</b>	<b>6SL3210-... ..1PH31 4AL0</b>
LO base load power	132 kW
LO base load input current	137 A
LO base load output current	142 A
HO base load power	110 kW
HO base load input current	122 A
HO base load output current	115 A
Siemens fuse according to IEC/UL	3NE1 225-0 / 200 A
Fuse according to IEC/UL, Class J	200 A
Power loss without filter	2.56 kW
Power loss with filter	2.59 kW
Required cooling air flow	153 l/s
Weight without filter	60 kg
Weight with filter	64 kg

Article number	LO base load output current for a pulse frequency of ...	
	[A]	
	2 kHz	4 kHz
6SL3210-1PH21-4□L0	14	8.4
6SL3210-1PH22-0□L0	19	11.4
6SL3210-1PH22-3□L0	23	13.8
6SL3210-1PH22-7□L0	27	16.2
6SL3210-1PH23-5□L0	35	21
6SL3210-1PH24-2□L0	42	25.2
6SL3210-1PH25-2□L0	52	31.2
6SL3210-1PH26-2□L0	62	37.2
6SL3210-1PH28-0UL0	80	48
6SL3210-1PH31-0□L0	100	60
6SL3210-1PH31-2□L0	115	69
6SL3210-1PH31-4□L0	142	85.2

The permissible motor cable length depends on the particular cable type and the pulse frequency that has been selected

### 10.3.2 Technical data, PM240

#### Typical inverter load cycles

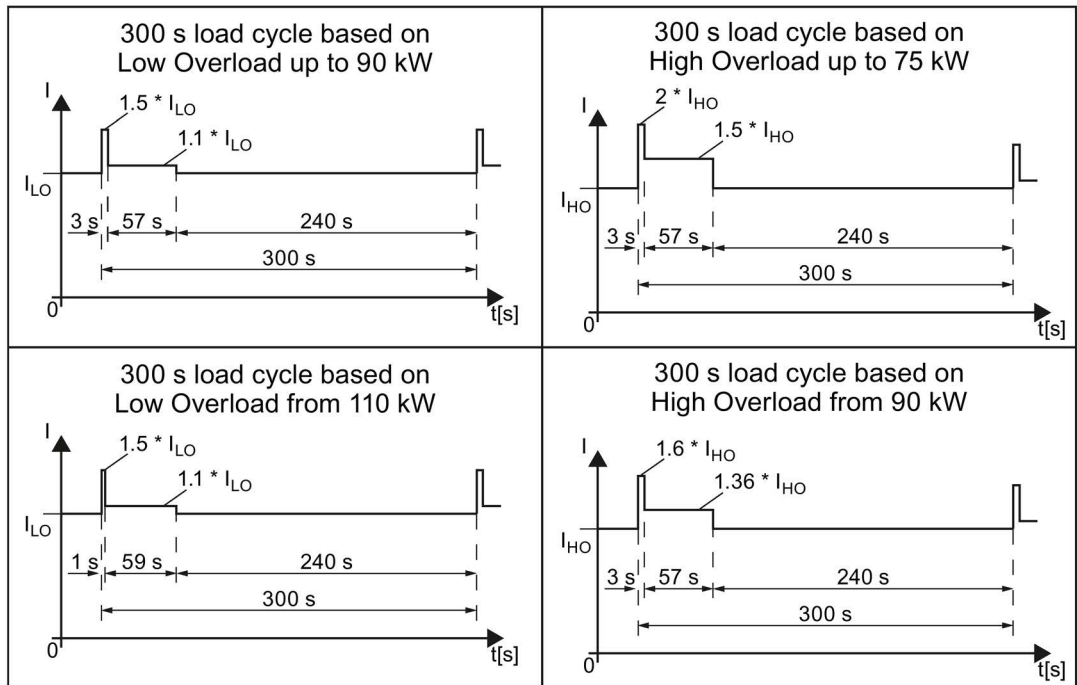



Image 10-2 "High Overload" and "Low Overload" load cycles

10.3.2.1 General data, PM240

Property	Version
Line voltage	3-phase 380 ... 480 VAC ± 10%
Output voltage	3-phase 0 VAC ... input voltage x 0.95 (max.)
Input frequency	50 Hz ... 60 Hz, ± 3 Hz
Output frequency	0 Hz ... 550 Hz, depending on the control mode
Power factor λ	0.7 ... 0.85
Inrush current	< LO base load input current
Overvoltage category according to EN 60664-1	The inverter insulation is designed for surge voltages according to overvoltage Category III.
Short-circuit current rating (SCCR)	≤ 65 kA rms
Pulse frequency (factory setting)	<ul style="list-style-type: none"> <li>• 4 kHz for devices with an LO base load power ≤ 90 kW</li> <li>• 2 kHz for devices with an LO base load power &gt; 90 kW</li> </ul> <p>Can be set in 2 kHz steps in the range 2 kHz ... 16 kHz. If you increase the pulse frequency, the inverter reduces the maximum output current.</p>  Current derating depending on the pulse frequency (Page 459)
Electromagnetic compatibility	The devices are suitable for environments of categories C1 and C2 according to IEC/EN 61800-3.
Braking methods	DC braking, compound braking, dynamic braking with integrated braking chopper
Degree of protection according to EN 60529	IP20      Installation in a control cabinet required
<b>Environmental conditions for transport in the transport packaging</b>	
Climatic environmental conditions	The device is suitable for temperatures that conform with 2K4 according to EN 60721-3-2 in the range -40° ... +70° C
Mechanical environmental conditions (shocks and vibrations)	The device is suitable for operation in mechanical environmental conditions that conform with 2M3 according to EN 60721-3-2
Protection against chemical substances	The device is protected against damaging chemical substances that conform with 2C2 according to EN 60721-3-2
Biological environmental conditions	The device is suitable for operation in biological environmental conditions that conform with 2B2 according to EN 60721-3-2
<b>Environmental conditions for long-term storage in the product packaging</b>	
Climatic environmental conditions	The device is suitable for temperatures that conform with 1K4 according to EN 60721-3-1 in the range -25° ... +55° C
Mechanical environmental conditions (shocks and vibrations)	The device is suitable for operation in mechanical environmental conditions that conform with 1M2 according to EN 60721-3-1
Protection against chemical substances	The device is protected against damaging chemical substances that conform with 1C2 according to EN 60721-3-1
Biological environmental conditions	The device is suitable for operation in biological environmental conditions that conform with 1B2 according to EN 60721-3-1



Property	Version
<b>Environmental conditions during operation</b>	
Installation altitude	<ul style="list-style-type: none"> <li>• LO base load power 0.37 kW ... 132 kW: up to 1000 m above sea level</li> </ul>
 Restrictions for special ambient conditions (Page 475)	<ul style="list-style-type: none"> <li>• HO base load power: 160 kW ... 250 kW: up to 2000 m above sea level</li> <li>• HO base load power: 132 kW ... 200 kW: up to 4000 m above sea level</li> </ul>
Climatic environmental conditions	<p>Better than 3K3 according to EN 60721-3-3</p> <ul style="list-style-type: none"> <li>• Temperature range without derating <sup>1)</sup> <ul style="list-style-type: none"> <li>– LO base load power 0.37 kW ... 250 kW: -10° C ... +40° C</li> <li>– HO base load power: 0.37 kW ... 110 kW: -10° C ... +50° C</li> <li>– HO base load power: 132 kW ... 200 kW: -10° C ... +40° C</li> </ul> </li> <li>• Temperature range with derating <sup>1)</sup> <ul style="list-style-type: none"> <li>– LO/HO base load power: -10° C ... +60° C</li> </ul> </li> </ul> <p> Restrictions for special ambient conditions (Page 475)</p> <ul style="list-style-type: none"> <li>• Relative humidity: 5 ... 95%, condensation not permitted</li> <li>• Oil mist, salt mist, ice formation, condensation, dripping water, spraying water, splashing water and water jets are not permitted</li> </ul>
Mechanical environmental conditions (shocks and vibrations)	<p>The device is suitable for operation in mechanical environmental conditions that conform with 3M1 according to EN 60721-3-3</p> <ul style="list-style-type: none"> <li>• Vibration test according to IEC 60068-2-6 with ten vibration cycles per axis <ul style="list-style-type: none"> <li>– in the range 10 Hz ... 57Hz with a deflection of 0.075 mm</li> <li>– in the range 57 Hz ... 150Hz with an acceleration of 1 g</li> </ul> </li> <li>• Shock resistance according to IEC 60068-2-27 with three impulses per axis in both directions <ul style="list-style-type: none"> <li>– Peak acceleration: 5 g</li> <li>– Duration: 30 ms</li> </ul> </li> </ul>
Protection against chemical substances	protected against damaging chemical substances that conform with 3C2 according to EN 60721-3-3
Biological environmental conditions	suitable for operation in biological environmental conditions that conform with 3C2 according to EN 60721-3-3
Cooling air	clean and dry air
Contamination	suitable for environments with degree of pollution 2 according to EN 61800-5-1, condensation not permitted
<b>Approvals</b>	
UL <sup>2)</sup> , cUL <sup>2)</sup> , CE, C-tick, SEMI F47	

<sup>1)</sup> : Also observe the permissible ambient temperatures for the Control Unit and any Operator Panel (IOP or BOP-2).

<sup>2)</sup> Use UL-certified fuses in order to satisfy the UL requirements.

### 10.3.2.2 Power-dependent data, PM240

**Note**

The given input currents are valid for operation without a line reactor for a line voltage of 400 V with  $V_k = 1\%$  referred to the rated power of the inverter. If a line reactor is used, the specified values are reduced by a few percent.

**Note**

The values for Low Overload (LO) are identical with those of the rated values.

Table 10- 28 PM240, IP20, frame sizes A, 3-phase 380 ... 480 VAC

Article no. - without filter	6SL3224-...	...0BE13-7UA0	...0BE15-5UA0	...0BE17-5UA0
LO base load power		0.37 kW	0.55 kW	0.75 kW
LO base load input current		1.6 A	2.0 A	2.5 A
LO base load output current		1.3 A	1.7 A	2.2 A
HO base load power		0.37 kW	0.55 kW	0.75 kW
HO base load input current		1.6 A	2.0 A	2.5 A
HO base load output current		1.3 A	1.7 A	2.2 A
Fuse according to UL (from SIEMENS)		3NE1813-0, 16 A	3NE1813-0, 16 A	3NE1813-0, 16 A
Fuse according to UL (Class J, K-1 or K-5)		10 A	10 A	10 A
Power loss		0.097 kW	0.099 kW	0.102 kW
Required cooling air flow		4.8 l/s	4.8 l/s	4.8 l/s
Weight		1.2 kg	1.2 kg	1.2 kg

Table 10- 29 PM240, IP20, frame sizes A, 3-phase 380 ... 480 VAC

Article no. - without filter	6SL3224-...	...0BE21-1UA0	...0BE21-5UA0
LO base load power		1.1 kW	1.5 kW
LO base load input current		3.9 A	4.9 A
LO base load output current		3.1 A	4.1 A
HO base load power		1.1 kW	1.5 kW
HO base load input current		3.8 A	4.8 A
HO base load output current		3.1 A	4.1 A
Fuse according to UL (from SIEMENS)		3NE1813-0, 16 A	3NE1813-0, 16 A
Fuse according to UL (Class J, K-1 or K-5)		10 A	10 A
Power loss		0.108 kW	0.114 kW
Required cooling air flow		4.8 l/s	4.8 l/s
Weight		1.1 kg	1.1 kg

Table 10- 30 PM240, IP20, frame sizes B, 3-phase 380 ... 480 VAC

Article no. - without filter	6SL3224-...	...0BE22-2UA0	...0BE23-0UA0	...0BE24-0UA0
Article no. - with filter	6SL3224-...	...0BE22-2AA0	...0BE23-0AA0	...0BE24-0AA0
LO base load power		2.2 kW	3 kW	4 kW
LO base load input current		7.6 A	10.2 A	13.4 A
LO base load output current		5.9 A	7.7 A	10.2 A
HO base load power		2.2 kW	3 kW	4 kW
HO base load input current		7.6 A	10.2 A	13.4 A
HO base load output current		5.9 A	7.7 A	10.2 A
Fuse according to UL (from SIEMENS)		3NE1813-0, 16 A	3NE1813-0, 16 A	3NE1814-0, 20 A
Fuse according to UL (Class J, K-1 or K-5)		16 A	16 A	20 A
Power loss		0.139 kW	0.158 kW	0.183 kW
Required cooling air flow		24 l/s	24 l/s	24 l/s
Weight		4.3 kg	4.3 kg	4.3 kg

Table 10- 31 PM240, IP20, frame sizes C, 3-phase 380 ... 480 VAC

Article no. - without filter	6SL3224-...	...0BE25-5UA0	...0BE27-5UA0	...0BE31-1UA0
Article no. - with filter	6SL3224-...	...0BE25-5AA0	...0BE27-5AA0	...0BE31-1AA0
LO base load power		7.5 kW	11 kW	15 kW
LO base load input current		21.9 A	31.5 A	39.4 A
LO base load output current		18 A	25 A	32 A
HO base load power		5.5 kW	7.5 kW	11 kW
HO base load input current		16.7 A	23.7 A	32.7 A
HO base load output current		13.2 A	19 A	26 A
Fuse according to UL (from SIEMENS)		3NE1814-0, 20 A	3NE1814-0, 20 A	3NE1803-0, 35 A
Fuse according to UL (Class J, K-1 or K-5)		20 A	20 A	35 A
Power loss		0.240 kW	0.297 kW	0.396 kW
Required cooling air flow		55 l/s	55 l/s	55 l/s
Weight without filter		6.5 kg	6.5 kg	6.5 kg
Weight with filter		7 kg	7 kg	7 kg

10.3 Technical data, Power Modules

Table 10- 32 PM240, IP20, frame sizes D, 3-phase 380 ... 480 VAC

Article no. - without filter	6SL3224-...	...0BE31-5UA0	...0BE31-8UA0	...0BE32-2UA0
Article no. - with filter	6SL3224-...	...0BE31-5AA0	...0BE31-8AA0	...0BE32-2AA0
LO base load power		18.5 kW	22 kW	30 kW
LO base load input current		46 A	53 A	72 A
LO base load output current		38 A	45 A	60 A
HO base load power		15 kW	18.5 kW	22 kW
HO base load input current		40 A	46 A	56 A
HO base load output current		32 A	38 A	45 A
Fuse according to UL (SIEMENS)		3NE1817-0	3NE1818-0	3NE1820-0
Fuse according to UL (Class J)		---	---	---
Power loss		0.44 kW	0.55 kW	0.72 kW
		0.42 kW	0.52 kW	0.69 kW
Required cooling air flow		22 l/s	22 l/s	39 l/s
Weight without filter		13 kg	13 kg	13 kg
Weight with filter		16 kg	16 kg	16 kg

Table 10- 33 PM240, IP20, frame sizes E, 3-phase 380 ... 480 VAC

Article no. - without filter	6SL3224-...	...0BE33-0UA0	...0BE33-7UA0
Article no. - with filter	6SL3224-...	...0BE33-0AA0	...0BE33-7AA0
LO base load power		37 kW	45 kW
LO base load input current		88 A	105 A
LO base load output current		75 A	90 A
HO base load power		30 kW	37 kW
HO base load input current		73 A	90 A
HO base load output current		60 A	75 A
Fuse according to UL (SIEMENS)		3NE1021-0	3NE1022-0
Fuse according to UL (Class J)		---	---
Power losses without filter		0.99 kW	1.2 kW
Power losses with filter		1.04 kW	1.2 kW
Required cooling air flow		22 l/s	39 l/s
Weight without filter		16 kg	16 kg
Weight with filter		23 kg	23 kg

Table 10- 34 PM240, IP20, frame sizes F, 3-phase 380 ... 480 VAC

Article no. - without filter	6SL3224-...	...0BE34-5UA0	...0BE35-5UA0	...0BE37-5UA0
Article no. - with filter	6SL3224-...	...0BE34-5AA0	...0BE35-5AA0	...0BE37-5AA0
LO base load power		55 kW	75 kW	90 kW
LO base load input current		129 A	168 A	204 A
LO base load output current		110 A A	145 A	178 A
HO base load power		45 kW	55 kW	75 kW
HO base load input current		108 A	132 A	169 A
HO base load output current		90 A	110 A	145 A
Fuse according to UL (SIEMENS)		3NE1224-0	3NE1225-0	3NE1227-0
Fuse according to UL (Class J)		150 A, 600 V	200 A, 600 V	250 A, 600 V
Power losses without filter		1.4 kW	1.9 kW	2.3 kW
Power losses with filter		1.5 kW	2.0 kW	2.4 kW
Required cooling air flow		94 l/s	94 l/s	117 l/s
Weight without filter		36 kg	36 kg	36 kg
Weight with filter		52 kg	52 kg	52 kg

Table 10- 35 PM240, IP20, frame sizes F, 3-phase 380 ... 480 VAC

Article no. - without filter	6SL3224-...	...0BE38-8UA0	...0BE41-1UA0
LO base load power		110 kW	132 kW
LO base load input current		234 A	284 A
LO base load output current		205 A	250 A
HO base load power		90 kW	110 kW
HO base load input current		205 A	235 A
HO base load output current		178 A	205 A
Fuse according to UL (SIEMENS)		3NE1227-0	3NE1230-0
Fuse according to UL (Class J)		300 A, 600 V	400 A, 600 V
Power loss		2.4 kW	2.5 kW
Required cooling air flow		117 l/s	117 l/s
Cross section of line and motor cables		95 ... 120 mm <sup>2</sup> 3/0 ... 4/0 AWG	95 ... 120 mm <sup>2</sup> 3/0 ... 4/0 AWG
Tightening torque for line and motor cables		13 Nm / 115 lbf in	13 Nm / 115 lbf in
Weight		39 kg	39 kg

10.3 Technical data, Power Modules

Table 10- 36 PM240 frame sizes GX, 3-phase 380 ... 480 VAC

Article no. - without filter	6SL3224-...	...0XE41-3UA0	...0XE41-6UA0	...0XE42-0UA0
LO base load power		160 kW	200 kW	240 kW
LO base load input current		297 A	354 A	442 A
LO base load output current		302 A	370 A	477 A
HO base load power		132 kW	160 kW	200 kW
HO base load input current		245 A	297 A	354 A
HO base load output current		250 A	302 A	370 A
Fuse according to UL (SIEMENS)		3NE1333-2	3NE1333-2	3NE1436-2
Fuse according to UL (Class J)		---	---	---
Power loss,		3.9 kW	4.4 kW	5.5 kW
Required cooling air flow		360 l/s	360 l/s	360 l/s
Weight		176 kg	176 kg	176 kg

Current derating depending on the pulse frequency

MLFB	LO base load	Output base-load current for a pulse frequency of							
		2 kHz	4 kHz	6 kHz	8 kHz	10 kHz	12 kHz	14 kHz	16 kHz
6SL3224-...	kW	A	A	A	A	A	A	A	A
...0BE13-7UA0	0.37	--	<b>1.30</b>	1.11	0.91	0.78	0.65	0.59	0.52
...0BE15-5UA0	0.55	--	<b>1.70</b>	1.45	1.19	1.02	0.85	0.77	0.68
...0BE17-5UA0	0.75	--	<b>2.20</b>	1.87	1.54	1.32	1.10	0.99	0.88
...0BE21-1UA0	1.1	--	<b>3.10</b>	2.64	2.17	1.86	1.55	1.40	1.24
...0BE21-5UA0	1.5	--	<b>4.10</b>	3.49	2.87	2.46	2.05	1.85	1.64
...0BE22-2□A0	2.2	--	<b>5.90</b>	5.02	4.13	3.54	2.95	2.66	2.36
...0BE23-0□A0	3.0	--	<b>7.70</b>	6.55	5.39	4.62	3.85	3.47	3.08
...0BE24-0□A0	4.0	--	<b>10.20</b>	8.67	7.14	6.12	5.10	4.59	4.08
...0BE25-5□A0	7.5	--	<b>18.00</b>	16.20	13.30	11.40	9.50	8.60	7.60
...0BE27-5□A0	11.0	--	<b>25.00</b>	22.10	18.20	15.60	13.00	11.70	10.40
...0BE31-1□A0	15.0	--	<b>32.00</b>	27.20	22.40	19.20	16.00	14.40	12.80
...0BE31-5□A0	18.5	--	<b>38.00</b>	32.30	26.60	22.80	19.00	17.10	15.20
...0BE31-8□A0	22	--	<b>45.00</b>	38.25	31.50	27.00	22.50	20.25	18.00
...0BE32-2□A0	30	--	<b>60.00</b>	52.70	43.40	37.20	31.00	27.90	24.80
...0BE33-0□A0	37	--	<b>75.00</b>	63.75	52.50	45.00	37.50	33.75	30.00
...0BE33-7□A0	45	--	<b>90.00</b>	76.50	63.00	54.00	45.00	40.50	36.00
...0BE34-5□A0	55	--	<b>110.0</b>	93.50	77.00	--	--	--	--
...0BE35-5□A0	75	--	<b>145.0</b>	123.3	101.5	--	--	--	--
...0BE37-5□A0	90	--	<b>178.0</b>	151.3	124.6	--	--	--	--
...0BE38-8UA0	110	<b>205.0</b>	178.0	--	--	--	--	--	--
...0BE41-1UA0	132	<b>250.0</b>	205.0	--	--	--	--	--	--
...0XE41-3UA0	160	<b>302.0</b>	250.0	--	--	--	--	--	--
...0XE41-6UA0	200	<b>370.0</b>	302.0	--	--	--	--	--	--
...0XE42-0UA0	250	<b>477.0</b>	370.0	--	--	--	--	--	--

□: A inverter with integrated filter, U inverter without filter

The permissible motor cable length depends on the particular cable type and the pulse frequency that has been selected

10.3.3 Technical data, PM230 IP20

Typical inverter load cycles

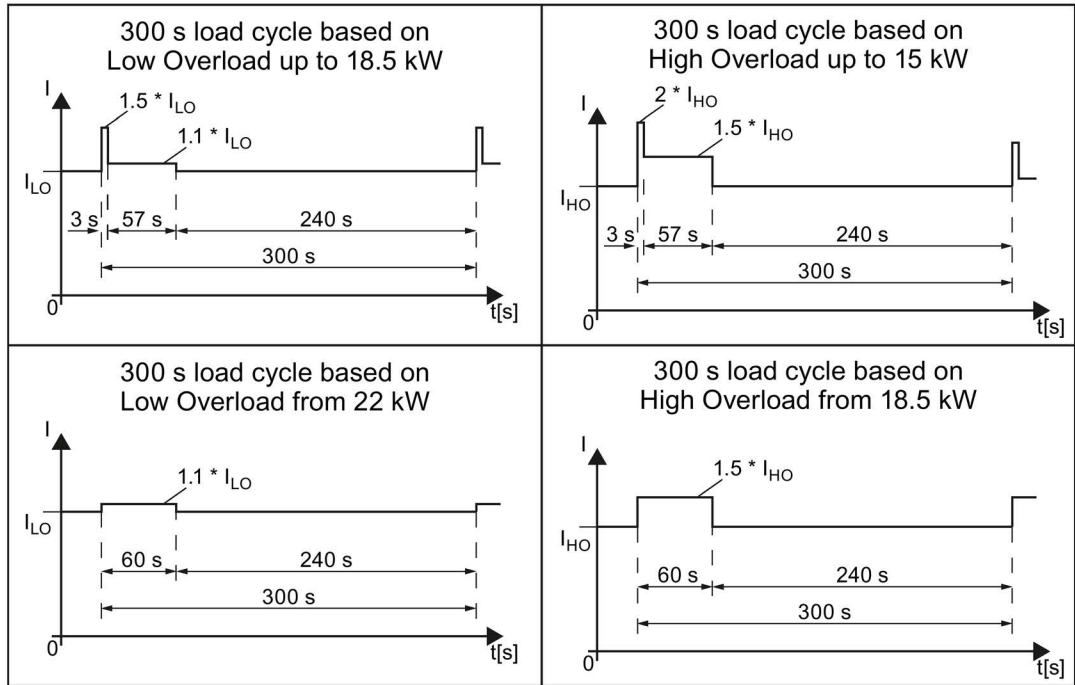

Image 10-3 Duty cycles, "High Overload" and "Low Overload"



### 10.3.3.1 General data, PM230 - IP20

Property	Version
Line voltage	3-phase 380 ... 480 VAC $\pm$ 10%
Output voltage	3-phase 0 VAC ... input voltage x 0.95 (max.)
Input frequency	50 Hz ... 60 Hz, $\pm$ 3 Hz
Output frequency	0 Hz ... 550 Hz, depending on the control mode
Power factor $\lambda$	0.9
Line impedance	$U_k \leq 1\%$ , line reactor not permissible
Inrush current	< LO base load input current
Pulse frequency (factory setting)	4 kHz The pulse frequency can be increased in 2 kHz steps up to 16 kHz (up to 8 kHz for 55 kW and 75 kW). An increase in the pulse frequency results in a lower output current.
Electromagnetic compatibility	Devices with filters in compliance with EN 61800-3: 2004 are suitable for Category C2 environments.
Braking methods	DC braking
Degree of protection	IP20 built-in units      IP20 when mounted in a control cabinet PT devices                      IP54 on the control cabinet wall
Operating temperature at	LO base load power without derating      0° C ... +40° C
	HO base load power without derating      0° C ... +50° C
	LO/HO base load power with derating:      Up to 60° C
	 Restrictions for special ambient conditions (Page 475)
Storage temperature	-40° C ... +70° C
Relative humidity	< 95% - condensation not permissible
Pollution	Protected according to pollution degree 2 according to EN 61800-5-1: 2007
Environmental requirements	Protected against damaging chemical substances according to environmental class 3C2 according to EN 60721-3-3: 1995
Shock and vibration	<ul style="list-style-type: none"> <li>• Long-term storage in the transport packaging according to Class 1M2 according to EN 60721-3-1: 1997</li> <li>• Transport in the transport packaging according to Class 2M3 according to EN 60721-3-2: 1997</li> <li>• Vibration during operation according to Class 3M2 according to EN 60721-3-3: 1995</li> </ul>
Installation altitude	without derating: up to 1000 m above sea level with derating: up to 4000 m above sea level  Restrictions for special ambient conditions (Page 475)
Permissible short-circuit current	Frame size D ... F: 65 kA <sup>1)</sup>
Overvoltage category	Supply circuits:              Overvoltage category III Non-supply circuits:        Overvoltage category II
Standards	UL <sup>1),2)</sup> , CE, C-tick The drive only satisfies the UL requirements when UL-certified fuses are used.

1) If fuse-protected with a listed Class J or 3NE1 fuse, rated voltage 600 VAC with the rated current of the specific inverter.

2) UL available soon for frame sizes D ... F

10.3.3.2 Power-dependent data, PM230, IP20

**Note**

The values for Low Overload (LO) are identical with those of the rated values.

Table 10- 37 PM230, IP20, frame sizes A, 3 AC 380 V ... 480 V

Article No. - without filter	6SL3210...	...1NE11-3UL1	...1NE11-7UL1	...1NE12-2UL1
Article No. - with filter	6SL3210...	...1NE11-3AL1	...1NE11-7AL1	...1NE12-2AL1
LO base load power		0.37 kW	0.55 kW	0.75 kW
LO base load input current		1.3 A	1.8 A	2.3 A
LO base load output current		1.3 A	1.7 A	2.2 A
HO base load power		0.25 kW	0.37 kW	0.55 kW
HO base load input current		0.9 A	1.3 A	1.8 A
HO base load output current		0.9 A	1.3 A	1.7 A
Fuse according to IEC		3NE1 813-0	3NE1 813-0	3NE1 813-0
Fuse according to UL		AJT2 / 3NE1 813-0	AJT4 / 3NE1 813-0	AJT4 / 3NE1 813-0
Power loss		0.04 kW	0.04 kW	0.05 kW
Required cooling air flow		1.5 l/s	1.5 l/s	4.5 l/s
Cross section of line and motor cables		1 ... 2.5 mm <sup>2</sup> 18 ... 14 AWG	1 ... 2.5 mm <sup>2</sup> 18 ... 14 AWG	1 ... 2.5 mm <sup>2</sup> 18 ... 14 AWG
Tightening torque for line and motor cables		0.5 Nm / 4 lbf in	0.5 Nm / 4 lbf in	0.5 Nm / 4 lbf in
Weight without filter		1.4 kg	1.4 kg	1.4 kg
Weight with filter		1.6 kg	1.6 kg	1.6 kg

Table 10- 38 PM230, IP20, frame sizes A, 3 AC 380 V ... 480 V

Article No. - without filter	6SL3210...	...1NE13-1UL1	...1NE14-1UL1	...-1NE15-8UL1
Article No. - with filter	6SL3210...	...1NE13-1AL10	...1NE14-1AL1	...-1NE15-8AL1
LO base load power		1.1 kW	1.5 kW	2.2 kW
LO base load input current		3.2 A	4.2 A	6.1 A
LO base load output current		3.1 A	4.1 A	5.9 A
HO base load power		0.75 kW	1.1 kW	1.5 kW
HO base load input current		2.3 A	3.2 A	4.2 A
HO base load output current		2.2 A	3.1 A	4.1 A
Fuse according to IEC		3NE1 813-0	3NE1 813-0	3NE1 813-0
Fuse according to UL		AJT6 / 3NE1 813-0	AJT6 / 3NE1 813-0	AJT10 / 3NE1 813-0
Power loss		0.06 kW	0.07 kW	0.08 kW
Required cooling air flow		4.5 l/s	4.5 l/s	4.5 l/s
Cross section of line and motor cables		1 ... 2.5 mm <sup>2</sup> 18 ... 14 AWG	1 ... 2.5 mm <sup>2</sup> 18 ... 14 AWG	1.5 ... 2.5 mm <sup>2</sup> 16 ... 14 AWG
Tightening torque for line and motor cables		0.5 Nm / 4 lbf in	0.5 Nm / 4 lbf in	0.5 Nm / 4 lbf in
Weight without filter		1.4 kg	1.4 kg	1.4 kg
Weight with filter		1.6 kg	1.6 kg	1.6 kg

Table 10- 39 PM230, IP20, frame sizes A, 3 AC 380 V ... 480 V

<b>Article No. - without filter</b>	<b>6SL3210...</b>	<b>...1NE17-7UL1</b>
<b>Article No. - with filter</b>	<b>6SL3210...</b>	<b>...1NE17-7AL1</b>
LO base load power		3 kW
LO base load input current		8.0 A
LO base load output current		7.7 A
HO base load power		2.2 kW
HO base load input current		6.1 A
HO base load output current		5.9 A
Fuse according to IEC		3NE1 813-0
Fuse according to UL		AJT10 / 3NE1 813-0
Power loss		0.11 kW
Required cooling air flow		4.5 l/s
Cross section of line and motor cables		1.5 ... 2.5 mm <sup>2</sup> 16 ... 14 AWG
Tightening torque for line and motor cables		0.5 Nm / 4 lbf in
Weight without filter		1.4 kg
Weight with filter		1.6 kg

Table 10- 40 PM230, PT, frame sizes A, 3 AC 380 V ... 480 V

<b>Article No. - without filter</b>	<b>6SL3211...</b>	<b>...1NE17-7UL1</b>
<b>Article No. - with filter</b>	<b>6SL3211...</b>	<b>...1NE17-7AL1</b>
LO base load power		3 kW
LO base load input current		8.0 A
LO base load output current		7.7 A
HO base load power		2.2 kW
HO base load input current		6.1 A
HO base load output current		5.9 A
Fuse according to IEC		3NE1 813-0
Fuse according to UL		AJT10 / 3NE1 813-0
Power loss		0.11 kW
Required cooling air flow		4.5 l/s
Cross section of line and motor cables		1.5 ... 2.5 mm <sup>2</sup> 16 ... 14 AWG
Tightening torque for line and motor cables		0.5 Nm / 4 lbf in
Weight without filter		1.7 kg
Weight with filter		1.9 kg

Technical data

10.3 Technical data, Power Modules

Table 10- 41 PM230, IP20, frame sizes B, 3-ph. 380 V AC... 480 V

Article No. - without filter	6SL3210...	...1NE21-0UL1	...1NE21-3UL1	...1NE21-8UL1
Article No. - with filter	6SL3210...	...1NE21-0AL1	...1NE21-3AL1	...1NE21-8AL1
LO base load power		4 kW	5.5 kW	7.5 kW
LO base load input current		10.5 A	13.6 A	18.6 A
LO base load output current		10.2 A	13.2 A	18 A
HO base load power		3 kW	4 kW	5.5 kW
HO base load input current		8.0 A	10.5 A	13.6 A
HO base load output current		7.7 A	10.2 A	13.2 A
Fuse according to IEC		3NE1 813-0	3NE1 814-0	3NE1 815-0
Fuse according to UL		AJT15 / 3NE1 813-0	AJT20 / 3NE1 814-0	AJT25 / 3NE1 815-0
Power loss		0.12 kW	0.15 kW	0.22 kW
Required cooling air flow		9.2 l/s	9.2 l/s	9.2 l/s
Cross section of line and motor cables		1.5 ... 6 mm <sup>2</sup> 16 ... 10 AWG	1.5 ... 6 mm <sup>2</sup> 16 ... 10 AWG	1.5 ... 6 mm <sup>2</sup> 16 ... 10 AWG
Tightening torque for line and motor cables		0.6 Nm / 5 lbf in	0.6 Nm / 5 lbf in	0.6 Nm / 5 lbf in
Weight without filter		2.8 kg	2.8 kg	2.8 kg
Weight with filter		3 kg	3 kg	3 kg

Table 10- 42 PM230, PT, frame sizes B, 3-ph. 380 V AC... 480 V

Article No. - without filter	6SL3211...	...1NE21-8UL1
Article No. - with filter	6SL3211...	...1NE21-8AL1
LO base load power		7.5 kW
LO base load input current		18.6 A
LO base load output current		18 A
HO base load power		5.5 kW
HO base load input current		13.6 A
HO base load output current		13.2 A
Fuse according to IEC		3NE1 815-0
Fuse according to UL		AJT25 / 3NE1 815-0
Power loss		0.22 kW
Required cooling air flow		9.2 l/s
Cross section of line and motor cables		1.5 ... 6 mm <sup>2</sup> 16 ... 10 AWG
Tightening torque for line and motor cables		0.6 Nm / 5 lbf in
Weight without filter		3.4 kg
Weight with filter		3.6 kg

Table 10- 43 PM230, IP20, frame sizes C, 3 AC 380 V ... 480 V

Article No. - without filter	6SL3210...	...1NE22-6UL1	...1NE23-2UL1	...1NE23-8UL1
Article No. - with filter	6SL3210...	...1NE22-6AL1	...1NE23-2AL1	...1NE23-8AL1
LO base load power		11 kW	15 kW	18.5 kW
LO base load input current		26.9 A	33.1 A	39.2 A
LO base load output current		26 A	32 A	38 A
HO base load power		7.5 kW	11 kW	15 kW
HO base load input current		18.6 A	26.9 A	33.1 A
HO base load output current		18 A	26 A	32 A
Fuse according to IEC		3NE1 803-0	3NE1 817-0	3NE1 817-0
Fuse according to UL		AJT35 / 3NE1 803-0	AJT45 / 3NE1 817-0	AJT50 / 3NE1 817-0
Power loss		0.3 kW	0.35 kW	0.45 kW
Required cooling air flow		18.5 l/s	18.5 l/s	18.5 l/s
Cross section of line and motor cables		6 ... 16 mm <sup>2</sup> 10 ... 6 AWG	6 ... 16 mm <sup>2</sup> 10 ... 6 AWG	6 ... 16 mm <sup>2</sup> 10 ... 6 AWG
Tightening torque for line and motor cables		1.5 Nm / 13 lbf in	1.5 Nm / 13 lbf in	1.5 Nm / 13 lbf in
Weight without filter		4.5 kg	4.5 kg	4.5 kg
Weight with filter		5.1 kg	5.1 kg	5.1 kg

Table 10- 44 PM230, PT, frame sizes C, 3 AC 380 V ... 480 V

Article No. - without filter	6SL3211...	...1NE23-8UL1
Article No. - with filter	6SL3211...	...1NE23-8AL1
LO base load power		18.5 kW
LO base load input current		39.2 A
LO base load output current		38 A
HO base load power		15 kW
HO base load input current		33.1 A
HO base load output current		32 A
Fuse according to IEC		3NE1 817-0
Fuse according to UL		AJT50 / 3NE1 817-0
Power loss		0.45 kW
Required cooling air flow		18.5 l/s
Cross section of line and motor cables		6 ... 16 mm <sup>2</sup> 10 ... 6 AWG
Tightening torque for line and motor cables		1.5 Nm / 13 lbf in
Weight without filter		5.4 kg
Weight with filter		6 kg

Technical data

10.3 Technical data, Power Modules

Table 10- 45 PM230, IP20, frame sizes D, 3 AC 380 V ... 480 V

Article No. - without filter	6SL3210...	...1NE24-5UL0	...1NE26-0UL0
Article No. - with filter	6SL3210...	...1NE24-5AL0	...1NE26-0AL0
LO base load power		22 kW	30 kW
LO base load input current		42 A	56 A
LO base load output current		45 A	60 A
HO base load power		18.5 kW	22 kW
HO base load input current		36 A	42 A
HO base load output current		38 A	45 A
Fuse according to IEC		3NE1818-0	3NE1820-0
Fuse according to UL		3NE1818-0	3NE1820-0
Power loss		0.52 kW	0.68 kW
Required cooling air flow		80 l/s	80 l/s
Cross section of line and motor cables		16 ... 35 mm <sup>2</sup> 5 ... 2 AWG	16 ... 35 mm <sup>2</sup> 5 ... 2 AWG
Tightening torque for line and motor cables		6 Nm / 53 lbf in	6 Nm / 53 lbf in
Weight without filter		11 kg	11 kg
Weight with filter		14 kg	14 kg

Table 10- 46 PM230, IP20, frame sizes E, 3 AC 380 V ... 480 V

Article No. - without filter	6SL3210...	...1NE27-5UL0	...1NE28-8UL0
Article No. - with filter	6SL3210...	...1NE27-5AL0	...1NE28-8AL0
LO base load power		37 kW	45 kW
LO base load input current		70 A	84 A
LO base load output current		75 A	90 A
HO base load power		30 kW	37 kW
HO base load input current		56 A	70 A
HO base load output current		60 A	75 A
Fuse according to IEC		3NE1021-0	3NE1022-0
Fuse according to UL		3NE1021-0	3NE1022-0
Power loss		0.99 kW	1.2 kW
Required cooling air flow		80 l/s	80 l/s
Cross section of line and motor cables		25 ... 50 mm <sup>2</sup> 3 ... 1-1/0 AWG	25 ... 50 mm <sup>2</sup> 3 ... 1-1/0 AWG
Tightening torque for line and motor cables		6 Nm / 53 lbf in	6 Nm / 53 lbf in
Weight without filter		15 kg	15 kg
Weight with filter		22 kg	22 kg

Table 10- 47 PM230, IP20, frame sizes F, 3 AC 380 V ... 480 V

<b>Article No. - without filter</b>	<b>6SL3210...</b>	<b>...1NE31-1UL0</b>	<b>...1NE31-5UL0</b>
<b>Article No. - with filter</b>	<b>6SL3210...</b>	<b>...1NE31-1AL0</b>	<b>...1NE31-5AL0</b>
LO base load power		55 kW	75 kW
LO base load input current		102 A	135 A
LO base load output current		110 A	145 A
HO base load power		45 kW	55 kW
HO base load input current		84 A	102 A
HO base load output current		90 A	110 A
Fuse according to IEC		3NE1224-0	3NE1225-0
Fuse according to UL		3NE1224-0	3NE1225-0
Power loss		1.4 kW	1.9 kW
Required cooling air flow		150 l/s	150 l/s
Cross section of line and motor cables		35 ... 120 mm <sup>2</sup> 2 ... 4/0 AWG	35 ... 120 mm <sup>2</sup> 2 ... 4/0 AWG
Tightening torque for line and motor cables		13 Nm / 115 lbf in	13 Nm / 115 lbf in
Weight without filter		33 kg	33 kg
Weight with filter		48 kg	48 kg

**Current reduction depending on pulse frequency**

Table 10- 48 Current reduction depending on the pulse frequency<sup>1)</sup>

LO base load	Output base-load current at a pulse frequency of							
	2 kHz	4 kHz	6 kHz	8 kHz	10 kHz	12 kHz	14 kHz	16 kHz
kW	A	A	A	A	A	A	A	A
0.37	--	1.30	1.11	0.91	0.78	0.65	0.59	0.52
0.55	--	1.70	1.45	1.19	1.02	0.85	0.77	0.68
0.75	--	2.20	1.87	1.54	1.32	1.10	0.99	0.88
1.1	--	3.10	2.64	2.17	1.86	1.55	1.40	1.24
1.5	--	4.10	3.49	2.87	2.46	2.05	1.85	1.64
2.2	--	5.90	5.02	4.13	3.54	2.95	2.66	2.36
3.0	--	7.70	6.55	5.39	4.62	3.85	3.47	3.08
4.0	--	10.20	8.67	7.14	6.12	5.10	4.59	4.08
5.5	--	13.20	11.22	9.24	7.92	6.60	5.94	5.28
7.5	--	18.00	15.30	12.60	10.80	9.00	8.10	7.20
11.0	--	26.00	22.10	18.20	15.60	13.00	11.70	10.40
15.0	--	32.00	27.20	22.40	19.20	16.00	14.40	12.80
18.5	--	38.00	32.30	26.60	22.80	19.00	17.10	15.20
22	--	45.00	38.25	31.50	27.00	22.50	20.25	18.00
30	--	60.00	51.00	42.00	36.00	30.00	27.00	24.00
37	--	75.00	63.75	52.50	45.00	37.50	33.75	30.00
45	--	90.00	76.50	63.00	54.00	45.00	40.50	36.00
55	--	110.0	93.50	77.00	66.00	55.00	49.50	44.00
75	--	145.0	123.3	101.5	--	--	--	--

<sup>1)</sup> The permissible motor cable length also depends on the cable type and the selected pulse frequency.



### 10.3.4 Technical data, PM250

#### 10.3.4.1 High Overload - Low Overload

##### Typical inverter load cycles

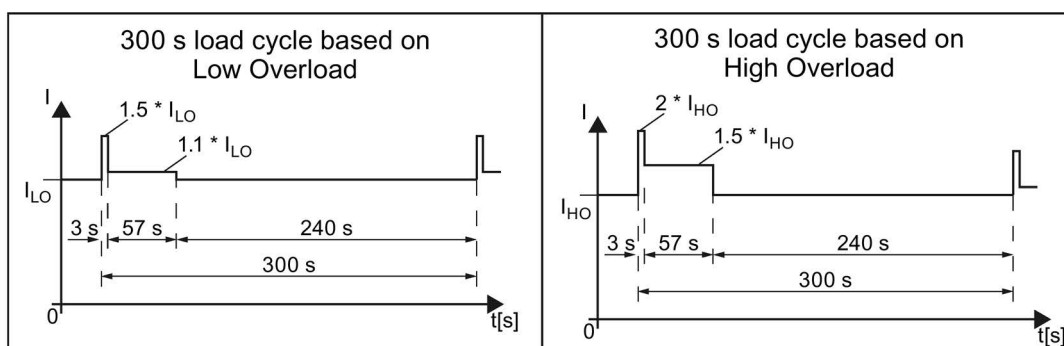

#### 10.3.4.2 General data, PM250

Property	Version
Line voltage	3-phase 380 ... 480 VAC $\pm$ 10%
Output voltage	3-phase 0 VAC ... input voltage x 0.87 (max.)
Input frequency	50 Hz ... 60 Hz, $\pm$ 3 Hz
Output frequency	0 ... 550 Hz, depending on the control mode
Power factor $\lambda$	0.9
Inrush current	< LO base load input current
Pulse frequency (factory setting)	4 kHz The pulse frequency can be adjusted up to 16 kHz in 2 kHz steps. The higher the pulse frequency, the lower the available output current.
	 Power-dependent data, PM250 (Page 471)
Electromagnetic compatibility	The devices comply with EN 61800-3: 2004 suitable for Category C2 and C3 environments.
Braking methods	DC braking, energy recovery (up to 100% of the output power)
Degree of protection	IP20 built-in devices (they must be installed in an electrical cabinet)
<b>Environmental conditions for transport in the transport packaging</b>	
Climatic environmental conditions	The device is suitable for temperatures that conform with 2K4 according to EN 60721-3-2 in the range $-40^{\circ}$ ... $+70^{\circ}$ C
Mechanical environmental conditions (shocks and vibrations)	The device is suitable for operation in mechanical environmental conditions that conform with 2M3 according to EN 60721-3-2
Protection against chemical substances	The device is protected against damaging chemical substances that conform with 2C2 according to EN 60721-3-2
Biological environmental conditions	The device is suitable for operation in biological environmental conditions that conform with 2B2 according to EN 60721-3-2

Property	Version
<b>Environmental conditions for long-term storage in the product packaging</b>	
Climatic environmental conditions	The device is suitable for temperatures that conform with 1K4 according to EN 60721-3-1 in the range -25° ... +55° C
Mechanical environmental conditions (shocks and vibrations)	The device is suitable for operation in mechanical environmental conditions that conform with 1M2 according to EN 60721-3-1
Protection against chemical substances	The device is protected against damaging chemical substances that conform with 1C2 according to EN 60721-3-1
Biological environmental conditions	The device is suitable for operation in biological environmental conditions that conform with 1B2 according to EN 60721-3-1
<b>Environmental conditions during operation</b>	
Installation altitude  Restrictions for special ambient conditions (Page 475)	without derating: up to 1000 m above sea level with derating: up to 4000 m above sea level
Climatic environmental conditions	<p>Better than 3K3 according to EN 60721-3-3</p> <ul style="list-style-type: none"> <li>• Temperature range without derating <sup>1)</sup> <ul style="list-style-type: none"> <li>– LO base load power 0 °C ... +40 °C</li> <li>– HO base load power: 0° C ... +50° C</li> </ul> </li> <li>• Temperature range with derating <sup>1)</sup> <ul style="list-style-type: none"> <li>– LO/HO base load power: 0 °C ... +60 °C</li> </ul> </li> </ul> <p> Restrictions for special ambient conditions (Page 475)</p> <ul style="list-style-type: none"> <li>• Relative humidity: 5 ... 95%, condensation not permitted</li> <li>• Oil mist, salt mist, ice formation, condensation, dripping water, spraying water, splashing water and water jets are not permitted</li> </ul>
Mechanical environmental conditions (shocks and vibrations)	<p>The device is suitable for operation in mechanical environmental conditions that conform with 3M1 according to EN 60721-3-3</p> <ul style="list-style-type: none"> <li>• Vibration test according to IEC 60068-2-6 with 10 vibration cycles per axis <ul style="list-style-type: none"> <li>– in the range 10 Hz ... 57Hz with a deflection of 0.075 mm</li> <li>– in the range 57 Hz ... 150Hz with an acceleration of 1 g</li> </ul> </li> <li>• Shock resistance according to IEC 60068-2-27 with three impulses per axis in both directions <ul style="list-style-type: none"> <li>– Peak acceleration: 5 g</li> <li>– Duration: 30 ms</li> </ul> </li> </ul>
Protection against chemical substances	protected against damaging chemical substances that conform with 3C2 according to EN 60721-3-3
Biological environmental conditions	suitable for operation in biological environmental conditions that conform with 3C2 according to EN 60721-3-3
Cooling air	clean and dry air
Pollution	suitable for environments with degree of pollution 2 according to EN 61800-5-1, condensation not permitted
<b>Approvals</b>	
UL, cUL, CE, c-tick, SEMI F47.	The drive only satisfies the UL requirements when UL-certified fuses are used.

### 10.3.4.3 Power-dependent data, PM250

**Note**

The values for Low Overload (LO) are identical with those of the rated values.

Table 10- 49 PM250, IP20, frame sizes C, 3 AC 380 V ... 480 V

Article No. - with filter	6SL3225-...	0BE25-5AA1	0BE27-5AA1	0BE31-1AA1
LO base load power		7.5 kW	11 kW	15 kW
LO base load input current		18 A	25 A	32 A
LO base load output current		18 A	25 A	32 A
HO base load power		5.5 kW	7.5 kW	11 kW
HO base load input current		13.2 A	19 A	26 A
HO base load output current		13.2 A	19 A	26 A
Fuse		20 A, Class J	32 A, Class J	35 A, Class J
Power loss		0.24 kW	0.30 kW	0.31 kW
Required cooling air flow		38 l/s	38 l/s	38 l/s
Tightening torque for line and motor cables		2.3 Nm / 20 lbf in	2.3 Nm / 20 lbf in	2.3 Nm / 20 lbf in
Weight		7.5 kg	7.5 kg	7.5 kg

Table 10- 50 PM250, IP20, frame sizes D, 3 AC 380 V ... 480 V

Article No. - with filter	6SL3225-...	0BE31-5AA0	0BE31-8AA0	0BE32-2AA0
LO base load power		18.5 kW	22 kW	30 kW
LO base load input current		36 A	42 A	56 A
LO base load output current		38 A	45 A	60 A
HO base load power		15 kW	18.5 kW	22 kW
HO base load input current		30 A	36 A	42 A
HO base load output current		32 A	38 A	45 A
Fuse according to IEC		3NA3820	3NA3822	3NA3824
Fuse according to UL		50 A, Class J 3NE1817-0	63 A, Class J 3NE1818-0	80 A, Class J 3NE1820-0
Power loss		0.44 kW	0.55 kW	0.72 kW
Required cooling air flow		22 l/s	22 l/s	39 l/s
Tightening torque for line and motor cables		6 Nm / 53 lbf in	6 Nm / 53 lbf in	6 Nm / 53 lbf in
Weight		15 kg	15 kg	16 kg

Technical data

10.3 Technical data, Power Modules

Table 10- 51 PM250, IP20, frame sizes E, 3 AC 380 V ... 480 V

Article No. - with filter	6SL3225-...	0BE33-0AA0	0BE33-7AA0
LO base load power		37 kW	45 kW
LO base load input current		70 A	84 A
LO base load output current		75 A	90 A
HO base load power		30 kW	37 kW
HO base load input current		56 A	70 A
HO base load output current		60 A	75 A
Fuse according to IEC		3NA3830	3NA3832
Fuse according to UL		100 A, Class J 3NE1821-0	125 A, Class J 3NE1822-0
Power loss		1.04 kW	1.2 kW
Required cooling air flow		22 l/s	39 l/s
Tightening torque for line and motor cables		6 Nm / 53 lbf in	6 Nm / 53 lbf in
Weight		21 kg	21 kg

Table 10- 52 PM250, IP20, frame sizes F, 3 AC 380 V ... 480 V

Article No. - with filter	6SL3225-...	0BE34-5AA0	0BE35-5AA0	0BE37-5AA0
LO base load power		55 kW	75 kW	90 kW
LO base load input current		102 A	135 A	166 A
LO base load output current		110 A	145 A	178 A
HO base load power		45 kW	55 kW	75 kW
HO base load input current		84 A	102 A	135 A
HO base load output current		90 A	110 A	145 A
Fuse according to IEC		3NA3836	3NA3140	3NA3144
Fuse according to UL		160 A, Class J 3NE1824-0	200 A, Class J 3NE1825-0	250 A, Class J 3NE1827-0
Power loss		1.5 kW	2.0 kW	2.4 kW
Required cooling air flow		94 l/s	94 l/s	117 l/s
Tightening torque for line and motor cables		13 Nm / 115 lbf in	13 Nm / 115 lbf in	13 Nm / 115 lbf in
Weight		51 kg	51 kg	51 kg

## Relationship between pulse frequency and current reduction

Table 10- 53 Current reduction depending on pulse frequency

Rated Power (LO)	Base load current (LO)	Base load current (LO) at pulse frequency of					
		4 kHz	6 kHz	8 kHz	10 kHz	12 kHz	14 kHz
kW	A	A	A	A	A	A	A
7.5	18.0	12.5	11.9	10.6	9.20	7.90	6.60
11	25.0	18.1	17.1	15.2	13.3	11.4	9.50
15	32.0	24.7	23.4	20.8	18.2	15.6	12.8
18.5	38.0	32.3	26.6	22.8	19.0	17.1	15.2
22	45.0	38.3	31.5	27.0	22.5	20.3	18.0
30	60.0	51.0	42.0	36.0	30.0	27.0	24.0
37	75.0	63.8	52.5	45.0	37.5	33.8	30.0
45	90.0	76.5	63.0	54.0	45.0	40.5	36.0
55	110	93.5	77.0	--	--	--	--
75	145	123	102	--	--	--	--
90	178	151	125	--	--	--	--

### 10.3.5 Technical data, PM260



You can find the technical data of the Power Module PM260 in the Internet:

Installation Guide for the PM260 Power Module

(<https://support.industry.siemens.com/cs/ww/en/view/79109730>)

### 10.3.6 Data regarding the power loss in partial load operation



You can find data regarding power loss in partial load operation in the Internet:

Partial load operation (<http://support.automation.siemens.com/WW/view/en/94059311>)

## 10.4 Restrictions for special ambient conditions

### Current de-rating depending on the ambient operating temperature

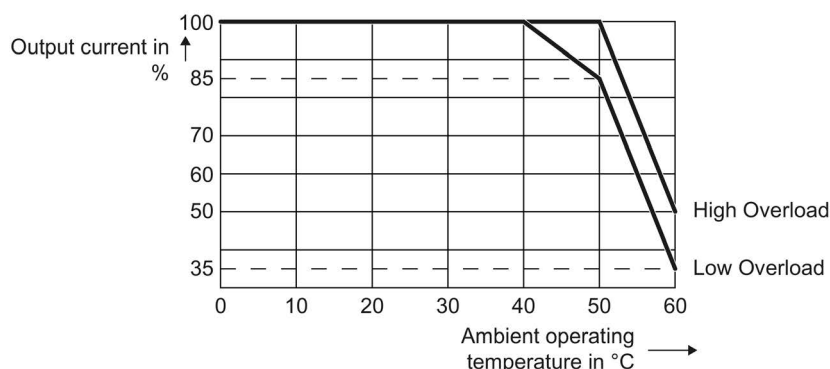

The Control Unit and operator panel can restrict the maximum permissible operating ambient temperature of the Power Module.

### Current derating depending on the installation altitude

Above 1000 m above sea level you must reduce the inverter output current as a result of the lower cooling capability of the air.

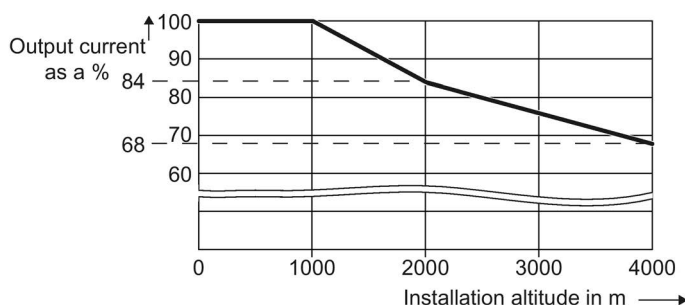

### Permissible line supplies depending on the installation altitude

- Installation altitude up to 2000 m above sea level
  - Connection to every supply system permitted for the inverter.
- Installation altitudes between 2000 m and 4000 m above sea level
  - Connection to a TN system with grounded neutral point.
  - TN systems with grounded line conductor are not permitted.
  - The TN line system with grounded neutral point can also be supplied using an isolation transformer.
  - The phase-to-phase voltage does not have to be reduced.





## Appendix

### A.1 New and extended functions

Table A- 1 New functions and function changes in firmware 4.7 SP6

	Function	SINAMICS								ET 200pro FC-2
		G120						G120D		
		G110M	G120C	CU230P-2	CU240B-2	CU240E-2	CU250S-2	CU240D-2	CU250D-2	
1	Support for the Power Module PM240-2, FSF frame sizes	-	-	✓	✓	✓	✓	-	-	-
	Support for safety functions Safe Torque Off (STO) via the terminals of the Power Module PM240-2 FSF frame size You can find additional information in the "Safety Integrated" function manual.  Overview of the manuals (Page 507)	-	-	-	-	✓	✓	-	-	-
2	Support for Power Module PM330 JX frame size	-	-	✓	-	-	-	-	-	-
3	Support for 1PC1 induction motors	✓	✓	✓	✓	✓	✓	✓	✓	✓
4	The control of synchronous reluctance takes into account the inductance of the output reactor.	-	-	✓	-	-	-	-	-	-
5	Support for motor temperature sensor PT1000	✓	✓	✓	✓	✓	✓	✓	✓	✓
6	New p4621 parameter for disabling PTC short-circuit monitoring	-	-	-	-	-	-	✓	✓	✓
7	Revision of the thermal motor model for protecting the motor against damage due to overheating in the stator or rotor	✓	✓	✓	✓	✓	✓	✓	✓	✓
8	Changing the quick commissioning in the "Standard Drive Control" application class: The motor data identification is no longer permanently set to p1900 = 12; instead, users select the appropriate motor data identification. Factory setting: p1900 = 2.	-	✓	✓	✓	✓	✓	-	-	-
9	The free function blocks are also available in the SINAMICS G120C.	✓	✓	✓	✓	✓	✓	✓	-	-

 Changes in this manual (Page 5)

Table A-2 New functions and function changes in firmware 4.7 SP3

	Function	SINAMICS								ET 200pro FC-2
		G110M	G120C	G120				G120D		
				CU230P-2	CU240B-2	CU240E-2	CU250S-2	CU240D-2	CU250D-2	
1	PM240-2 Power Modules, frame sizes FSD and FSE are supported	-	-	✓	✓	✓	✓	-	-	-
	The Safety Integrated basic function Safe Torque Off (STO) is supported via the terminals of the PM240-2 Power Module, frame sizes FSD and FSE	-	-	-	-	✓	✓	-	-	-
2	Revised PM230 Power Module with new article numbers supported: <ul style="list-style-type: none"> <li>IP55 degree of protection: 6SL3223-0DE . . . . <b>G</b> .</li> <li>IP20 degree of protection and Push Through: 6SL321 . - 1NE . . . . <b>G</b> .</li> </ul> You can find additional information in the "Safety Integrated" function manual.  Overview of the manuals (Page 507)	-	-	✓	✓	✓	-	-	-	-
	The Safety Integrated basic function Safe Torque Off (STO) is supported with the revised PM230 Power Module	-	-	-	-	✓	-	-	-	-
3	PM330 Power Module, frame size HX is supported	-	-	✓	-	-	-	-	-	-
4	1FP1 reluctance motors are supported	-	-	✓	-	-	-	-	-	-
5	Encoderless 1FK7 synchronous motors are supported <sup>1)</sup> Operation with 1FK7 synchronous motors without encoder has already been released with firmware V4.7 for SINAMICS G120D with CU240D-2 Control Units.	-	✓	-	✓	✓	✓	✓ <sup>1)</sup>	-	-
6	Encoderless 1FG1 geared synchronous motors are supported	-	✓	-	✓	✓	✓	✓	-	-
7	Selection list for 1PH8 induction motors in the STARTER and Startdrive commissioning wizard	-	✓	✓	✓	✓	✓	-	-	-
8	Updated selection list for 1LE1 induction motors in the STARTER and Startdrive commissioning wizard	✓	✓	✓	✓	✓	✓	✓	✓	✓
9	Motor support expanded with 1LE1, 1LG6, 1LA7 and 1LA9 induction motors	✓	-	-	-	-	-	-	-	-
10	Speed and position control obtain their respective actual value from an SSI encoder with incremental tracks. The output signals of the encoder are available as encoder 2 for position control and timer 1 for speed control.	-	-	-	-	-	✓	-	✓	-
11	Power Module with temperature-controlled fan	✓	-	-	-	-	-	-	-	-

	Function	SINAMICS								ET 200pro FC-2
		G120						G120D		
		G110M	G120C	CU230P-2	CU240B-2	CU240E-2	CU250S-2	CU240D-2	CU250D-2	
12	SINAMICS "Standard Drive Control" and "Dynamic Drive Control" application classes to simplify commissioning and increase the degree of ruggedness of the closed-loop motor control. The SINAMICS application classes are available with the following inverters: <ul style="list-style-type: none"> <li>• SINAMICS G120C</li> <li>• SINAMICS G120 with PM240, PM240-2 and PM330 Power Modules</li> </ul>	-	✓	✓	✓	✓	✓	-	-	-
13	Moment of inertia estimator with moment of inertia precontrol to optimize the speed controller in operation	✓	✓	-	✓	✓	✓	✓	✓	✓
14	Friction torque characteristic with automatic plotting to optimize the speed controller	✓	✓	-	✓	✓	✓	✓	✓	✓
15	Automatic optimization of the technology controller	-	-	✓	✓	✓	-	-	-	-
16	The sign of the system deviation for the additional, free technology controller can be switched over. A new parameter defines the sign of the system deviation matching the particular application, e.g. for cooling or heating applications.	-	-	✓	-	-	-	-	-	-
17	The technology controller output can be enabled and disabled during operation	-	✓	✓	✓	✓	✓	-	-	-
18	Ramp-function generator remains active with enabled technology controller	-	-	✓	-	-	-	-	-	-
19	Line contactor control using a digital output of the inverter to save energy when the motor is switched off	✓	✓	✓	✓	✓	✓	✓	✓	-
20	Fast flying restart for PM330 Power Modules: The "Flying restart" function does not have to wait for the motor demagnetization time, and identifies the motor speed without requiring a search operation.	-	-	✓	-	-	-	-	-	-
21	Load torque monitoring extended to include the following functions: <ul style="list-style-type: none"> <li>• Protection against blocking, leakage and dry running operation in pump applications</li> <li>• Protection against blocking and broken belts in fan applications</li> </ul>	✓	-	✓	✓	✓	-	-	-	-
22	Automatic switchover of the real time clock from daylight saving time (summer time) to standard time (winter time).	-	-	✓	-	-	-	-	-	-
23	New or revised default settings of the interfaces: p0015 macros 110, 112 and 120	-	-	✓	-	-	-	-	-	-
24	Expansion of the temperature sensors to include DIN-Ni1000 for analog inputs AI 2 and AI 3	-	-	✓	-	-	-	-	-	-

	Function	SINAMICS									
		G120							G120D		ET 200pro FC-2
		G110M	G120C	CU230P-2	CU240B-2	CU240E-2	CU250S-2	CU240D-2	CU250D-2		
25	Communication via AS-Interface. Default setting of the communication via AS-i: p0015 macros 30, 31, 32 and 34	✓	-	-	-	-	-	-	-	-	
26	Communication expansion via Modbus: Adjustable parity bit, access to parameters and analog inputs	✓	✓	✓	✓	✓	✓	-	-	-	
27	Extending communication via BACnet: Access to parameters and analog inputs	-	-	✓	-	-	-	-	-	-	
28	The bus error LED for communication via USS and Modbus can be switched off	✓	✓	✓	✓	✓	✓	-	-	-	
29	Default of the minimum speed to 20% of the rated motor speed	-	-	✓	-	-	-	-	-	-	
30	For commissioning with an operator panel, the inverter automatically backs up the measured data retentively in the ROM after identification of the motor data.	✓	✓	✓	✓	✓	✓	✓	✓	✓	
31	The result of the energy savings calculation for flow machines is available as a connector	✓	✓	✓	✓	✓	✓	✓	✓	✓	
32	New "ppm" unit (parts per million) for unit switching	✓	✓	✓	✓	✓	✓	✓	✓	✓	
33	Displaying speeds during commissioning via operator panel in units of Hz instead of rpm. Conversion from Hz to rpm via p8552	-	-	✓	-	-	-	-	-	-	
34	Voltage-dependent current limit for 600V devices of Power Module PM330 and PM240-2	-	-	✓	✓	✓	✓	-	-	-	

Table A- 3 New functions and function changes in Firmware 4.7

	Function	SINAMICS							
		G110M	G120C	G120				G120D	
				CU230P-2	CU240B-2	CU240E-2	CU250S-2	CU240D-2	CU250D-2
1	Supporting the identification & maintenance datasets (I&M1 ... 4)	✓	✓	✓	✓	✓	✓	✓	✓
2	Fall in pulse rate with increased drive power required by the motor <ul style="list-style-type: none"> <li>The inverter temporarily lowers the pulse frequency if required when the motor is started up, and simultaneously increases the current limit.</li> </ul>	✓	✓	✓	✓	✓	✓	✓	✓
3	S7 communication <ul style="list-style-type: none"> <li>Direct data exchange between the inverter and human-machine interface (HMI).</li> <li>Increase in communication performance with the engineering tools and support of the S7 routing</li> </ul>	✓	✓	✓	✓	✓	✓	✓	✓
4	The basic functions of Safety Integrated are unrestrictedly available in all control types with 1FK7 encoderless permanent-field synchronous motors	-	-	-	-	-	-	✓	-
5	Direct selection of the 1FK7 encoderless permanent-field synchronous motors using the Article No. with allocated code number <ul style="list-style-type: none"> <li>It is not necessary to input individual motor data</li> </ul>	-	-	-	-	-	-	✓	-
6	Pulse input as source of setpoint value <ul style="list-style-type: none"> <li>The inverter calculates its speed setpoint from a sequence of pulses at the digital input.</li> </ul>	-	-	-	-	-	✓	-	-
7	Dynamic IP address assignment (DHCP) and temporary device names for PROFINET	✓	✓	✓	-	✓	✓	✓	✓
8	PROFenergy Slave profile 2 and 3	✓	✓	✓	-	✓	✓	✓	✓
9	Uniform behavior for component replacement <ul style="list-style-type: none"> <li>After a component is replaced, an inverter with activated Safety Integrated will report what type of component has been replaced using a unique code.</li> </ul>	✓	✓	-	-	✓	✓	✓	✓
10	Improved direct-component control in PM230 <ul style="list-style-type: none"> <li>Optimized efficiency for pump and fan applications</li> </ul>	-	-	✓	-	-	-	-	-
11	Rounding down of BACnet and macros	-	-	✓	-	-	-	-	-

Table A- 4 New functions and function changes in Firmware 4.6.6

	Function	SINAMICS						
		G120C	G120				G120D	
			CU230P-2	CU240B-2	CU240E-2	CU250S-2	CU240D-2	CU250D-2
1	Support for the new Power Modules <ul style="list-style-type: none"> <li>PM330 IP20 GX</li> </ul>	-	✓	-	-	-	-	-

Table A- 5 New functions and function changes in Firmware 4.6

	Function	SINAMICS						
		G120C	G120				G120D	
	CU230P-2		CU240B-2	CU240E-2	CU250S-2	CU240D-2	CU250D-2	
1	Support for the new Power Modules <ul style="list-style-type: none"> <li>PM240-2 IP20 FSB ... FSC</li> <li>PM240-2 in through-hole technology FSB ... FSC</li> </ul>	-	✓	✓	✓	✓	-	-
2	Support for the new Power Modules <ul style="list-style-type: none"> <li>PM230 in through-hole technology FSD ... FSF</li> </ul>	-	✓	✓	✓	-	-	-
3	Motor data preassignment for the 1LA/1LE motors via code number <ul style="list-style-type: none"> <li>During quick commissioning with the operator panel, set the motor data using a code number</li> </ul>	✓	✓	✓	✓	✓	✓	✓
4	Extension to communication via CANopen <ul style="list-style-type: none"> <li>CAN velocity, ProfilTorque, SDO channel for each axis, system test with CodeSys, suppression of ErrorPassiv alarm</li> </ul>	✓	✓	-	-	✓	-	-
5	Extension to communication via BACnet <ul style="list-style-type: none"> <li>Multistate value objects for alarms, commandable AO objects, objects for configuring the PID controller</li> </ul>	-	✓	-	-	-	-	-
6	Communication via EtherNet/IP	✓	✓	-	✓	✓	✓	✓
7	Skip frequency band for analog input <ul style="list-style-type: none"> <li>A symmetrical skip frequency band can be set for each analog input around the 0 V range.</li> </ul>	✓	✓	✓	✓	✓	✓	-
8	Changing the control of the motor holding brake	✓	-	✓	✓	✓	✓	-
9	Safety function SBC (Safe Brake Control) <ul style="list-style-type: none"> <li>Secure control of a motor holding brake when using the "Safe Brake Module" option</li> </ul>	-	-	-	-	✓	-	-
10	Safety function SS1 (Safe Stop 1) without speed monitoring	-	-	-	-	✓	-	-
11	Straightforward selection of standard motors <ul style="list-style-type: none"> <li>Selection of 1LA... and 1LE... motors with an operator panel using a list containing code numbers</li> </ul>	✓	✓	✓	✓	✓	✓	✓
12	Firmware update via memory card	✓	✓	✓	✓	✓	✓	✓
13	Safety info channel <ul style="list-style-type: none"> <li>BICO source r9734.0...14 for the status bits of the extended safety functions</li> </ul>	-	-	-	✓	✓	✓	✓
14	Diagnostic alarms for PROFIBUS	✓	✓	✓	✓	✓	✓	✓

Table A-6 New functions and function changes in Firmware 4.5

	Function	SINAMICS					
		G120C	G120			G120D	
	CU230P-2		CU240B-2	CU240E-2	CU240D-2	CU250D-2	
1	Support for the new Power Modules: <ul style="list-style-type: none"> <li>PM230 IP20 FSA ... FSF</li> <li>PM230 in a push-through FSA ... FSC</li> </ul>	-	✓	✓	✓	-	-
2	Support for the new Power Modules: <ul style="list-style-type: none"> <li>PM240-2 IP20 FSA</li> <li>PM240-2 in push-through FSA</li> </ul>	-	✓	✓	✓	-	-
3	New Control Units with PROFINET support	✓	✓	-	✓	✓	✓
4	Support of the PROFIenergy profile	✓	✓	-	✓	✓	✓
5	Shared device support via PROFINET	✓	✓	-	✓	✓	✓
6	Write protection	✓	✓	✓	✓	✓	✓
7	Know-how protection	✓	✓	✓	✓	✓	✓
8	Adding a second command data set (CDS0 → CDS0 ... CDS1) (All other inverters have four command data sets)	✓	-	-	-	-	-
9	Position control and basic positioner	-	-	-	-	-	✓
10	Support of an HTL encoder	-	-	-	-	✓	✓
11	Support of an SSI encoder	-	-	-	-	-	✓
12	Fail-safe digital output	-	-	-	-	✓	✓



## A.2 Parameter

Parameters are the interface between the firmware of the converter and the commissioning tool, e.g. an Operator Panel.

### Adjustable parameters

Adjustable parameters are the "adjusting screws" with which you adapt the converter to its particular application. If you change the value of an adjustable parameter, then the converter behavior also changes.

Adjustable parameters are shown with a "p" as prefix, e.g. p1082 is the parameter for the maximum motor speed.

### Display parameters

Display parameters allow internal measured quantities of the converter and the motor to be read.

The Operator Panel and STARTER represent display parameters with an "r" prefix, for example, r0027 is the parameter for the converter output current.

### Parameters that in many cases help

Table A- 7    **How to switch to commissioning mode or restore the factory setting**

Parameter	Description
p0010	<b>Commissioning parameters</b> 0: Ready (factory setting) 1: Perform quick commissioning 3: Carry out motor commissioning 5: Technological applications and units 15: Define number of data sets 30: Factory setting - initiate restore factory settings

Table A- 8    **How to determine the firmware version of the Control Unit**

Parameter	Description
r0018	<b>Firmware version is displayed</b>

Table A- 9    **How to select the command and setpoint sources of the inverter**

Parameter	Description
p0015	Select the default of the interfaces.  Installing Control Unit (Page 90)

Table A- 10 How to set the ramp-up and ramp-down

Parameter	Description
p1080	Minimum rotation speed
p1082	Maximum rotation speed
p1120	Ramp-up time
p1121	Ramp-down time

Table A- 11 This is how you set the closed-loop type

Parameter	Description
p1300	0: V/f control with linear characteristic 1: V/f control with linear characteristic and FCC 2: V/f control with parabolic characteristic 3: V/f control with adjustable characteristic 4: V/f control with linear characteristic and ECO 5: V/f control for drives requiring a precise frequency (textile area) 6: V/f control for drives requiring a precise frequency and FCC 7: V/f control with parabolic characteristic and ECO 19: V/f control with independent voltage setpoint 20: Speed control (without encoder) 22: Torque control (without encoder)

Not all Power Modules offer for selection all the listed control modes. The control modes permitted for your device are offered during the commissioning.

Table A- 12 This is how you optimize the starting behavior of the V/f control for a high breakaway torque and overload

Parameter	Description
p1310	<b>Voltage boost to compensate ohmic losses</b> The voltage boost is active from standstill up to the rated speed. It is at its highest at speed 0 and continually decreases as the speed increases. Value of the voltage boost at speed 0 in V: $1.732 \times \text{rated motor current (p0305)} \times \text{stator resistance (r0395)} \times \text{p1310} / 100\%$
p1311	<b>Voltage boost when accelerating</b> The voltage boost is effective from standstill up to the rated speed. It is independent of the speed and has a value in V of: $1.732 \times \text{rated motor current (p0305)} \times \text{stator resistance (p0350)} \times \text{p1311} / 100\%$
p1312	<b>Voltage boost when starting</b> Setting to additionally boost the voltage when starting, however only when accelerating for the first time.

Table A- 13 How to change the inverter pulse frequency

Parameter	Description
p1800	<p><b>Setting the inverter pulse frequency</b></p> <p>The pulse frequency depends on the power unit.</p> <p> Technical data, Power Modules (Page 428)</p> <p>If you increase the pulse frequency, the inverter output current decreases (the maximum output current is displayed in r0076).</p> <p>If you use a sine-wave filter, you can only set the pulse frequency to values that are permissible for the filter.</p> <p>When operated with an output reactor, the pulse frequency is limited to a maximum of 4 kHz.</p>

### A.3 Handling the BOP 2 operator panel

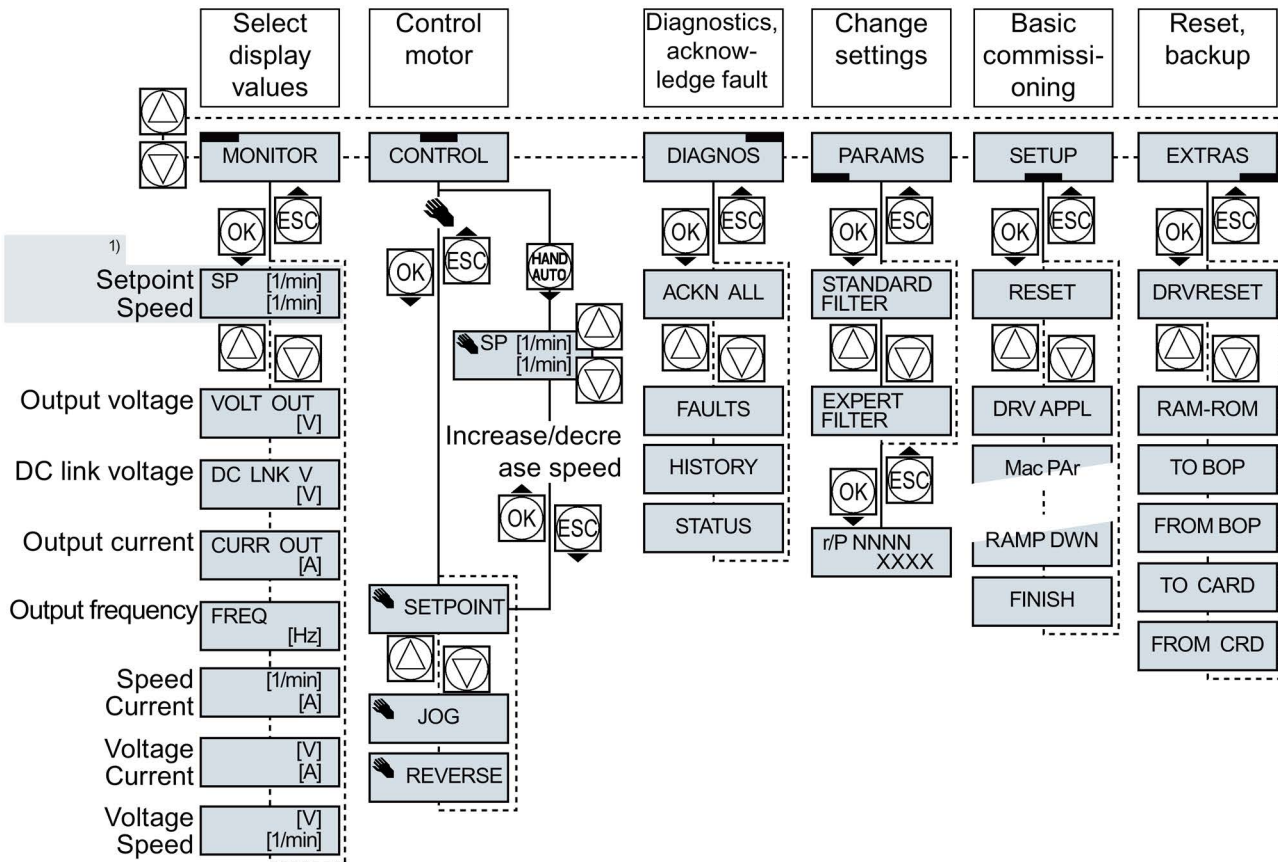

1) Status display once the power supply for the inverter has been switched on.

Image A-1 Menu of the BOP-2

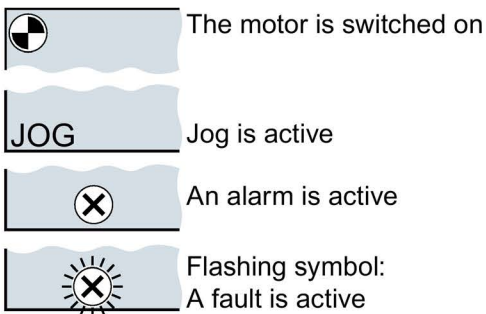





Image A-2 Other keys and symbols of the BOP-2

Procedure for switching the motor on and off via the operator panel:

1. Press MANUAL AUTO 
2. Master control of the inverter is released via the BOP-2 
3. Switch on motor 
4. Switch off the motor 

## A.3.1 Changing settings using BOP-2

### Changing settings using BOP-2

You can modify the settings of your inverter by changing the values of its parameters. The inverter only permits changes to "write" parameters. Write parameters begin with a "P", e.g. P45.

The value of a read-only parameter cannot be changed. Read-only parameters begin with an "r", for example: r2.

#### Procedure



To change write parameters using the BOP-2, proceed as follows:

1. Select the menu to display and change parameters.  
Press the OK key.

2. Select the parameter filter using the arrow keys.  
Press the OK key.

- STANDARD: The inverter only displays the most important parameters.
- EXPERT: The inverter displays all of the parameters.

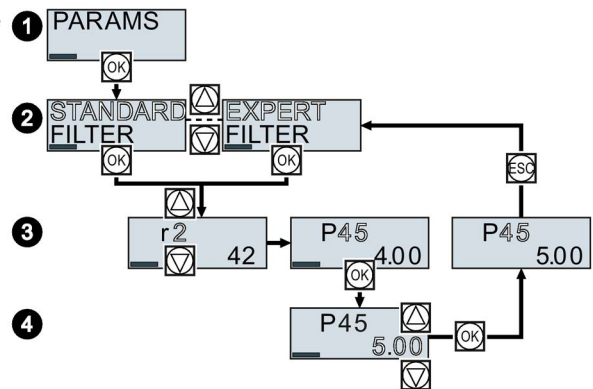

3. Select the required number of a write parameter using the arrow keys.  
Press the OK key.
4. Select the value of the write parameter using the arrow keys.  
Accept the value with the OK key.

- You have now changed a write parameter using the BOP-2.

The inverter saves all the changes made using the BOP-2 so that they are protected against power failure.

## A.3.2 Changing indexed parameters

### Changing indexed parameters

For indexed parameters, several parameter values are assigned to a parameter number. Each of the parameter values has its own index.

**Procedure**



To change an indexed parameter, proceed as follows:

1. Select the parameter number.
2. Press the OK key.
3. Set the parameter index.
4. Press the OK key.
5. Set the parameter value for the selected index.

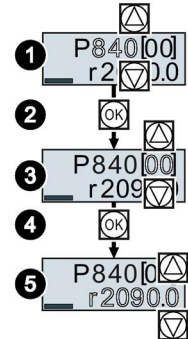

■ You have now changed an indexed parameter.

**A.3.3 Directly entering the parameter number and value**

**Directly select the parameter number**

The BOP-2 offers the possibility of setting the parameter number digit by digit.

**Precondition**

The parameter number is flashing in the BOP-2 display.

**Procedure**



To select the parameter number directly, proceed as follows:

1. Press the OK button for longer than five seconds.
2. Change the parameter number digit-by-digit.  
If you press the OK button then the BOP-2 jumps to the next digit.
3. If you have entered all of the digits of the parameter number, press the OK button.

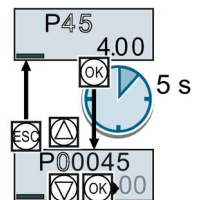

■ You have now entered the parameter number directly.

## Entering the parameter value directly

The BOP-2 offers the option of setting the parameter value digit by digit.

### Precondition

The parameter value flashes in the BOP-2 display.

### Procedure



1 To select the parameter value directly, proceed as follows:

1. Press the OK button for longer than five seconds.
2. Change the parameter value digit-by-digit.  
If you press the OK button then the BOP-2 jumps to the next digit.
3. If you have entered all of the digits of the parameter value, press the OK button.

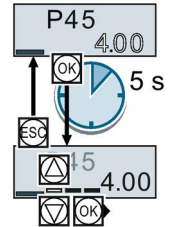

- You have now entered the parameter value directly.

## A.3.4 A parameter cannot be changed

### When must you not change a parameter?

The converter indicates why it currently does not permit a parameter to be changed:

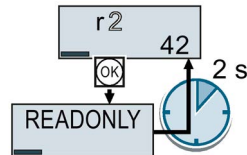

You have attempted to change a read-only parameter.

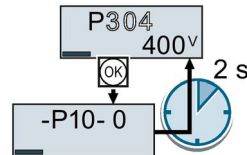

You must change to quick commissioning to set this parameter.

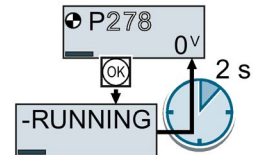

You must turn the motor off to set this parameter.

The operating state in which you can change a parameter is provided in the List Manual for each parameter.

## A.4 The device trace in STARTER

### Description

The device trace graphically displays inverter signals with respect to time.

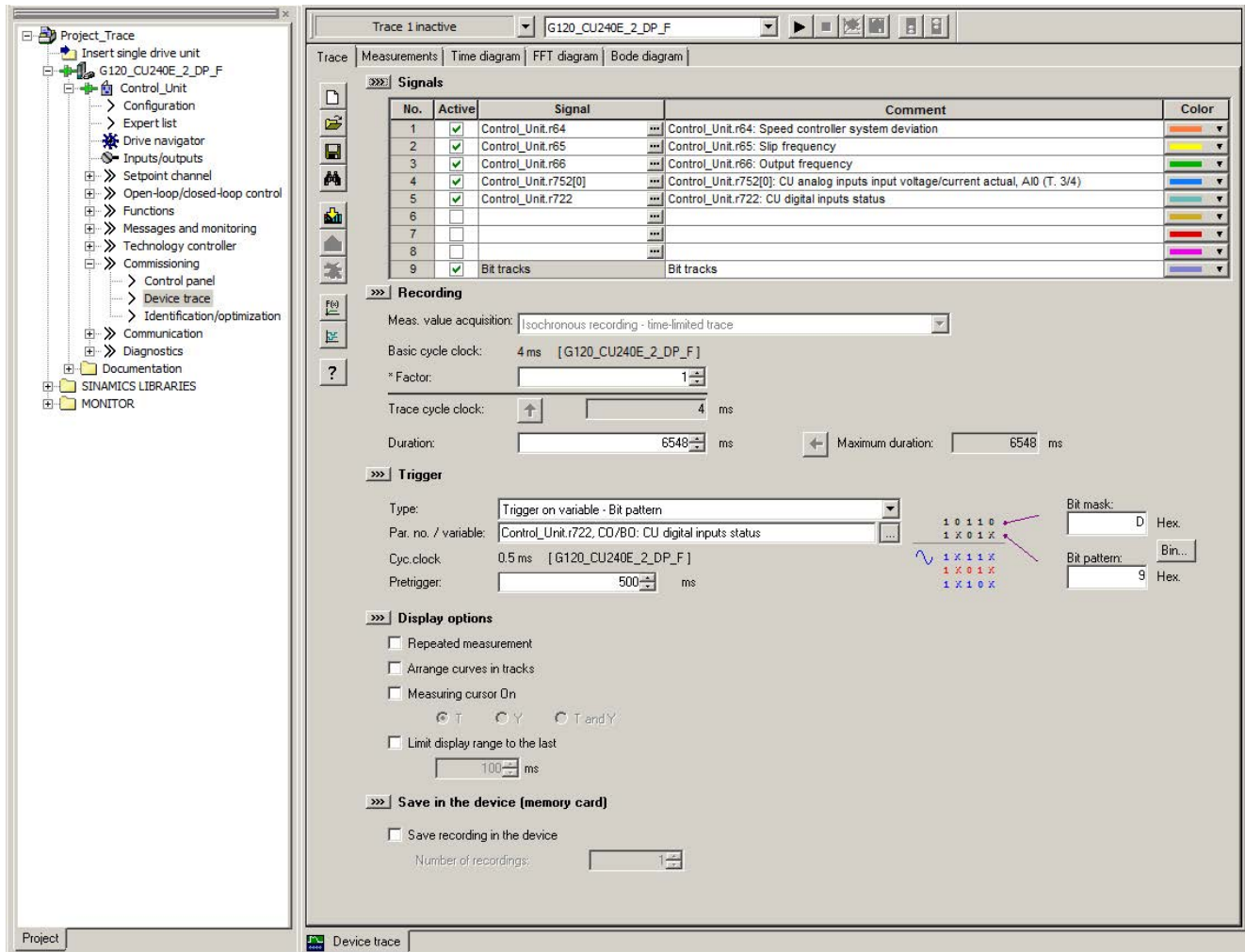

### Signals

In two settings that are independent of one another, using  you can interconnect eight signals each.

### Recording

You can start a measurement as frequently as you require. As long as you do not exit STARTER, the results remain under the "Measurements" tab with data and time. When terminating STARTER or under the "Measurements" tab, you can save the measurement results in the \*.trc format.



If you require more than two settings for your measurements, you can either save the individual settings in the project or export them in \*.clg format, and load or import them, if necessary.

You can record individual bits of a parameter (e.g. r0722. 1) by allocating the relevant bit using "bit track" (  ).

Using the mathematical function (  ) you can define a curve, for example, the difference between the speed setpoint and the speed actual value.

The device trace shows "individual bits" or "mathematical functions" as signal No. 9.

## Recording cycle and duration

The device trace records data in a CU-dependent basic cycle clock. The maximum recording duration depends on the number of recorded signals and the trace clock cycle.

Proceed as follows to extend the recording duration:

1. Multiply the trace clock cycle by an integral number.
2. Accept the displayed maximum duration using .

Alternatively, you can also specify the measurement period and then calculate the trace clock cycle of STARTER using .

## Trigger (condition to start the device trace)

The device trace starts as soon as you press the  (start trace) button.

Using the button , you can define another trigger to start the device trace.

The pretrigger defines the time in which the signals are traced before the trigger condition. As a consequence, the trigger condition traces itself.

### Example of a bit pattern as trigger:

You must define the pattern and value of a bit parameter for the trigger. To do so, proceed as follows:

Using , select "Trigger to variable - bit pattern"

Using , select the bit parameter

Using , open the screen form in which you set the bits and their values for the start condition

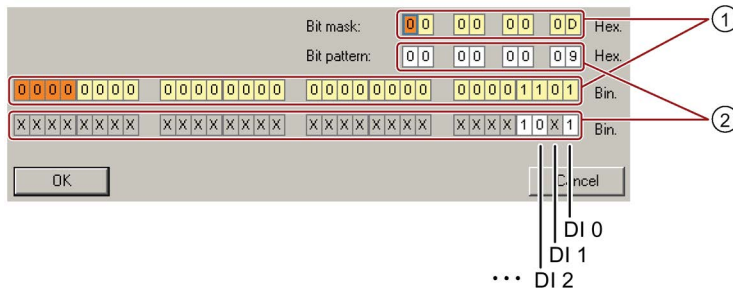

- ① Select the bits for the trace trigger, upper row hex format, lower row binary format
- ② Define the bits for the trace trigger, upper row hex format, lower row binary format

Image A-3 Trigger as bit pattern of r0722 (status of the digital inputs)

In the example, the trace starts if digital inputs DI 0 and DI 3 are high, and DI 2 is low. The state of the other digital inputs is not relevant for the trigger condition.

Further, you can either set an alarm or fault as start condition.

### Display options

In this area, you can set how the measurement results are displayed.

- Repeat measurement  
This places the measurements that you wish to perform at different times above one other.
- Arrange curves in tracks  
This defines whether the device trace will show all measured values on a common zero line or on separate zero lines.
- Measuring cursor On  
This allows you to analyze the measuring intervals in more detail.

### Save to device (memory card)

In this area, you define whether the device trace will save successive measurements in directory /USER/SINAMICS/DATA/TRACE on a inserted memory card.

### Displaying the measurements backed up on the memory card

#### Procedure



To display the measurements backed up on the memory card, proceed as follows:

1. Insert the memory card into a card reader.
2. Go to the "Measurements" tab in the device trace.
3. Open the read out ACX files with the "Open measurements" button.



STARTER shows the measurements backed up on the memory card.

## A.5 Interconnecting signals in the inverter

### A.5.1 Fundamentals

The following functions are implemented in the inverter:

- Open-loop and closed-loop control functions
- Communication functions
- Diagnosis and operating functions

Every function comprises one or several blocks that are interconnected with one another.

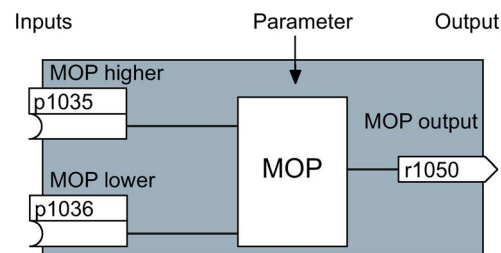

Image A-4 Example of a block: Motorized potentiometer (MOP)

Most of the blocks can be adapted to specific applications using parameters.

You cannot change the signal interconnection within the block. However, the interconnection between blocks can be changed by interconnecting the inputs of a block with the appropriate outputs of another block.

The signal interconnection of the blocks is realized, contrary to electric circuitry, not using cables, but in the software.

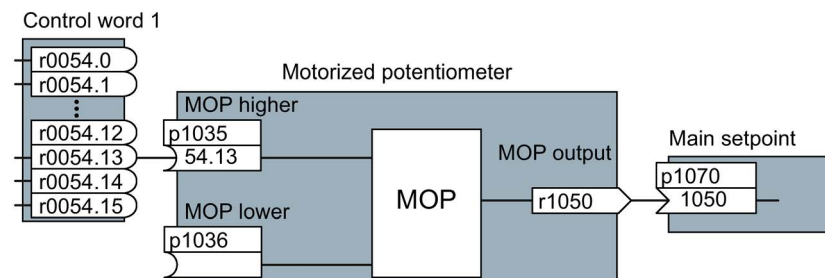

Image A-5 Example: Signal interconnection of two blocks for digital input 0

**Binectors and connectors**

Connectors and binectors are used to exchange signals between the individual blocks:

- Connectors are used to interconnect "analog" signals (e.g. MOP output speed)
- Binectors are used to interconnect digital signals (e.g. "Enable MOP up" command)

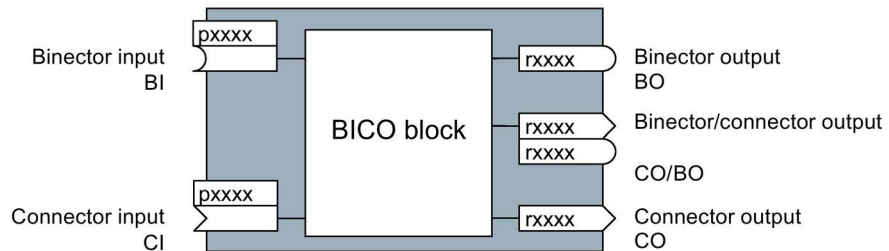

Image A-6 Symbols for binector and connector inputs and outputs

Binector/connector outputs (CO/BO) are parameters that combine more than one binector output in a single word (e.g. r0052 CO/BO: status word 1). Each bit in the word represents a digital (binary) signal. This summary reduces the number of parameters and simplifies parameter assignment.

Binector or connector outputs (CO, BO or CO/BO) can be used more than once.

**Interconnecting signals**

**When must you interconnect signals in the inverter?**

If you change the signal interconnection in the inverter, you can adapt the inverter to a wide range of requirements. This does not necessarily have to involve highly complex functions.

Example 1: Assign a different function to a digital input.

Example 2: Switch the speed setpoint from the fixed speed to the analog input.

**Principle when connecting BICO blocks using BICO technology**

When interconnecting the signal, the following principle applies: **Where does the signal come from?**

An interconnection between two BICO blocks consists of a connector or a binector and a BICO parameter. The input of a block must be assigned the output of a different block: In the BICO parameters, enter the parameter numbers of the connector/binector that should supply its output signal to the BICO parameter.

**How much care is required when you change the signal interconnection?**

Note which changes you make. A subsequent analysis of the set signal interconnections is possible only by evaluating the parameter list.

We recommend that you use the STARTER and Startdrive commissioning tools for setting the signal interconnections.

**Where can you find additional information?**

- This manual suffices for assigning a different meaning to the digital inputs.
- The parameter list in the List Manual is sufficient for more complex signal interconnections.
- The function diagrams in the List Manual provide a complete overview of the factory setting for the signal interconnections and the setting options.

**A.5.2 Example****Moving a basic control logic into the inverter**

A conveyor system is to be configured in such a way that it can only start when two signals are present simultaneously. These could be the following signals, for example:

- The oil pump is running (the required pressure level is not reached, however, until after 5 seconds)
- The protective door is closed

To implement this task, you must insert free function blocks between digital input 0 and the command to switch on the motor (ON/OFF1).

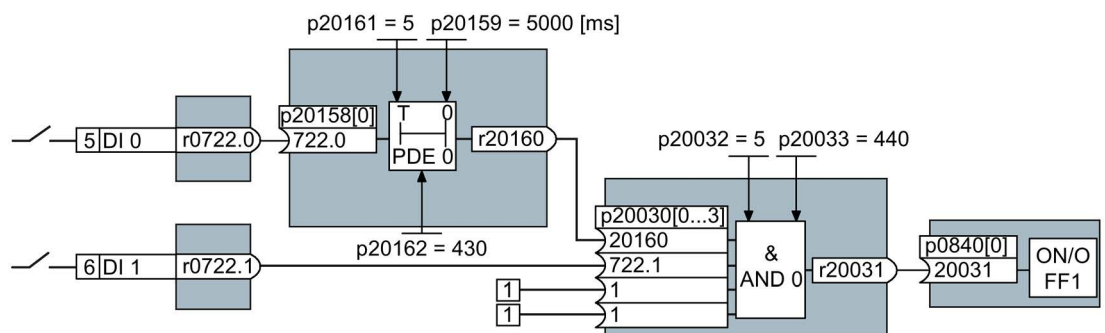

Image A-7 Example: Signal interconnection for control logic

The signal of digital input 0 (DI 0) is fed through a time block (PDE 0) and is interconnected with the input of a logic block (AND 0). The signal of digital input 1 (DI 1) is interconnected to the second input of the logic block. The logic block output issues the ON/OFF1 command to switch-on the motor.

**Setting the control logic**

Parameter	Description
p20161 = 5	The time block is enabled by assigning to runtime group 5 (time slice of 128 ms)
p20162 = 430	Run sequence of the time block within runtime group 5 (processing before the AND logic block)
p20032 = 5	The AND logic block is enabled by assigning to runtime group 5 (time slice of 128 ms)
p20033 = 440	Run sequence of the AND logic block within runtime group 5 (processing after the time block)
p20159 = 5000.00	Setting the delay time [ms] of the time module: 5 seconds
p20158 = 722.0	Connect the status of DI 0 to the input of the time block r0722.0 = Parameter that displays the status of digital input 0.
p20030[0] = 20160	Interconnect the timer block to the 1st input of the AND
p20030[1] = 722.1	Interconnect the status of DI 1 with the 2nd AND input r0722.1 = Parameter that displays the status of digital input 1.
p0840 = 20031	Interconnect the AND output to ON/OFF1

**Explanation of the example using the ON/OFF1 command**

Parameter p0840[0] is the input of the "ON/OFF1" block of the inverter. Parameter r20031 is the output of the AND block. To interconnect ON/OFF1 with the output of the AND block, set p0840 = 20031.

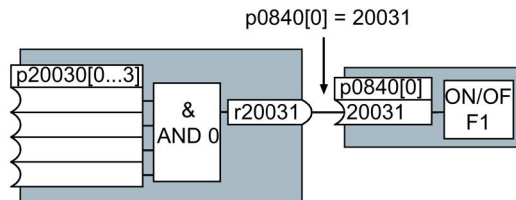

Image A-8 Interconnecting blocks by setting p0840[0] = 20031

## A.6 Connecting the safety-related input

The following examples show the interconnection of the safety-related input accordance with PL d to EN 13849-1 and SIL2 according to IEC61508. You can find additional examples and information in the "Safety Integrated" function manual.

The inverter allows a PM-switching output as well as a PP-switching output to be connected.

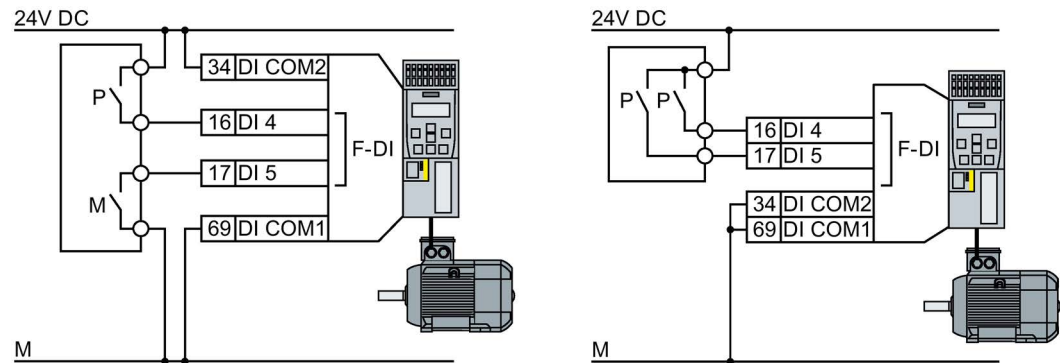

Image A-9 Connecting a PM-switching and a PP-switching output

The following examples comply with PL d according to EN 13849-1 and SIL2 according to IEC 61508 for the case that all components are installed in one control cabinet.

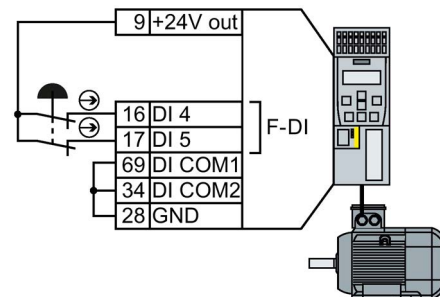

Image A-10 Connecting a sensor, e.g. Emergency Stop mushroom pushbutton or limit switch

A.6 Connecting the safety-related input

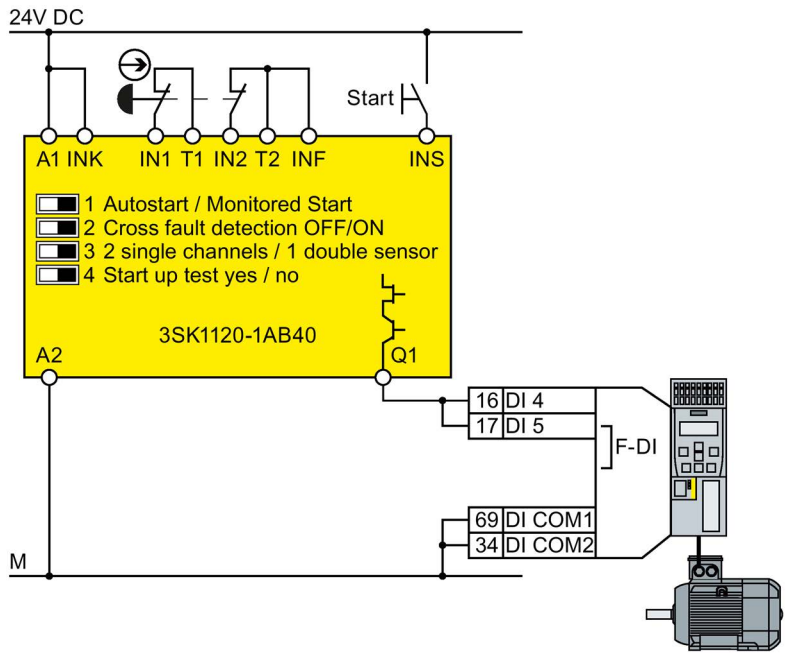

Image A-11 Connecting a safety relay, e.g. SIRIUS 3SK11

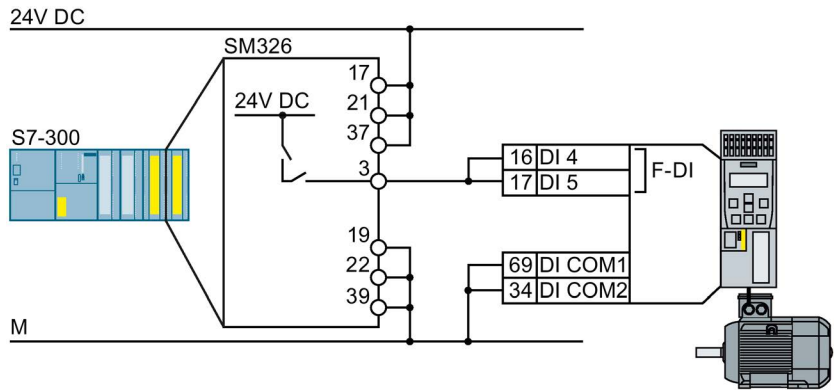



Image A-12 Connecting an F digital output module, e.g. SIMATIC F digital output module

The Safety Integrated function manual provides additional connection options and connections in separate control cabinets.

 Overview of the manuals (Page 507)



## A.7 Acceptance tests for the safety functions

### A.7.1 Recommended acceptance test

The following descriptions for the acceptance test are recommendations that illustrate the principle of acceptance. You may deviate from these recommendations if you check the following once you have completed commissioning:

- Correct assignment of the interfaces of each converter with the safety function:
  - Fail-safe inputs
  - PROFIsafe address
- Correct setting of the STO safety function.

---

**Note**

Perform the acceptance test with the maximum possible velocity and acceleration in order to test the expected maximum braking distances and braking times.

---

**Note****Non-critical alarms**

The following alarms are issued following each system ramp-up and are not critical for acceptance:

- A01697
  - A01796
-

A.7 Acceptance tests for the safety functions

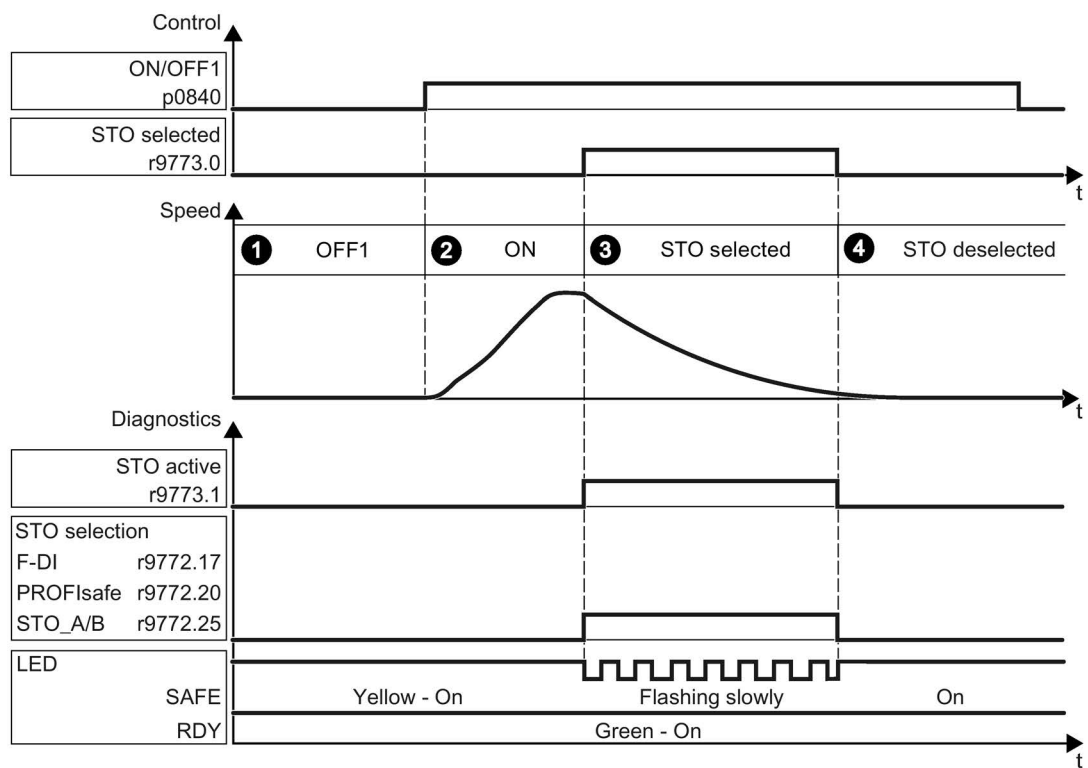



Image A-13 Acceptance test for STO (basic functions)

## Procedure



- 1 To perform an acceptance test of the STO function as part of the basic functions, proceed as follows:
- 2

			Status	
1.	<b>The inverter is ready</b>			
	<ul style="list-style-type: none"> <li>• The inverter signals neither faults nor alarms of the safety functions (r0945[0...7], r2122[0...7]).</li> <li>• STO is not active (r9773.1 = 0).</li> </ul>			
2.	<b>Switch on motor</b>			
	2.1.	Enter a speed setpoint ≠ 0.		
	2.2.	Switch on the motor (ON command).		
	2.3.	Check that the correct motor is running.		
3.	<b>Select STO</b>			
	3.1.	Select STO while the motor is running. <i>Test each configured activation, e.g. via digital inputs and PROFIsafe.</i>		
	3.2.	Check the following:		
		When controlled via PROFIsafe	When controlled via fail-safe digital inputs (F-DI)	When controlled via terminals STO_A and STO_B on Power Module PM240-2
		<ul style="list-style-type: none"> <li>• The inverter signals the following: "STO selection via PROFIsafe" (r9772.20 = 1)</li> </ul>	<ul style="list-style-type: none"> <li>• The inverter signals the following: "STO Selection via terminal" (r9772.17 = 1)</li> </ul>	<ul style="list-style-type: none"> <li>• The inverter signals the following: "STO Selection via terminal on Power Module" (r9772.25 = 1)</li> </ul>
	<ul style="list-style-type: none"> <li>• If a mechanical brake is not available, the motor coasts down. A mechanical brake brakes the motor and holds it to ensure that it remains at standstill.</li> </ul>			
<ul style="list-style-type: none"> <li>• The inverter signals neither faults nor alarms of the safety functions (r0945[0...7], r2122[0...7]).</li> </ul>				
<ul style="list-style-type: none"> <li>• The inverter signals the following: "STO is selected" (r9773.0 = 1). "STO is active" (r9773.1 = 1).</li> </ul>				
4.	<b>Deselect STO</b>			
	4.1.	Deselect STO.		
	4.2.	Check the following:		
<ul style="list-style-type: none"> <li>• STO is not active (r9773.1 = 0).</li> </ul>				
<ul style="list-style-type: none"> <li>• The inverter signals neither faults nor alarms of the safety functions (r0945[0...7], r2122[0...7]).</li> </ul>				

 You have performed the acceptance test of the STO function.

## A.7.2 Machine documentation

### Machine or plant description

Designation	...
Type	...
Serial number	...
Manufacturer	...
End customer	...
<b>Block diagram of the machine and/or plant:</b> ... ... ... ... ... ...	

### Inverter data

Table A- 14 Hardware version of the safety-related inverter

Labeling the drive	Article number and hardware version of the inverter
...	...
...	...

### Function table

Table A- 15 Active safety functions depending on the operating mode and safety equipment

Operating mode	Safety equipment	Drive	Selected safety function	Checked
...	...	...	...	
...	...	...	...	
<i>Example:</i>				
<i>Automatic</i>	<i>Protective door closed</i>	<i>Conveyor belt</i>	---	---
	<i>Protective door open</i>	<i>Conveyor belt</i>	STO	
	<i>Emergency Stop button pressed</i>	<i>Conveyor belt</i>	STO	

**Acceptance test reports**

File name of the acceptance reports	
...	...
...	...

**Data backup**

Data	Storage medium			Holding area
	Archiving type	Designation	Date	
Acceptance test reports	...	...	...	...
PLC program	...	...	...	...
Circuit diagrams	...	...	...	...

**Countersignatures****Commissioning engineer**

This confirms that the tests and checks have been carried out properly.

Date	Name	Company/dept.	Signature
...	...	...	...

**Machine manufacturer**

This confirms that the settings recorded above are correct.

Date	Name	Company/dept.	Signature
...	...	...	...

## A.7.3 Documenting the settings for the basic functions, firmware V4.4 ... V4.7 SP6

Drive = &lt;pDO-NAME\_v&gt;

Table A- 16 Firmware version

Name	Number	Value
Control Unit firmware version	r18	<r18_v>
SI version, safety functions integrated in the drive (processor 1)	r9770	<r9770_v>

Table A- 17 Monitoring cycle

Name	Number	Value
SI monitoring clock cycle (processor 1)	r9780	<r9780_v>

Table A- 18 Checksums

Name	Number	Value
SI module identifier, Control Unit	r9670	<r9670_v>
SI module identifier, Power Module	r9672	<r9672_v>
SI reference checksum SI parameters (processor 1)	p9799	<p9799_v>
SI reference checksum SI parameters (processor 2)	p9899	<p9899_v>

Table A- 19 Settings of the safety functions

Name	Number	Value
SI enable, functions integrated in the drive	p9601	<p9601_v>
<i>Only for the CU250S-2 Control Unit</i>   SI enable safe brake control	p9602	<p9602_v>
SI PROFIsafe address	p9610	<p9610_v>
F-DI switch over discrepancy time	p9650	<p9650_v>
SI STO debounce time	p9651	<p9651_v>
<i>Only for the CU250S-2 Control Unit</i>   SI Safe Stop 1 delay time	p9652	<p9652_v>
SI forced dormant error detection timer	p9659	<p9659_v>
SI forced checking procedure STO via PM terminals time	p9661	<p9661_v>

Table A- 20 Safety logbook

Name	Number	Value
SI checksum to check changes	r9781[0]	<r9781[0]_v>
SI checksum to check changes	r9781[1]	<r9781[1]_v>
SI change control time stamp	r9782[0]	<r9782[0]_v>
SI change control time stamp	r9782[1]	<r9782[1]_v>

## A.8 Manuals and technical support

### A.8.1 Overview of the manuals



#### Manuals with additional information that can be downloaded

- CU240B/E-2 Compact Operating Instructions  
<https://support.industry.siemens.com/cs/ww/en/view/109477361>  
 Commissioning inverters.

- CU240B/E-2 operating instructions  
<https://support.industry.siemens.com/cs/ww/en/view/109478828>  
 Installing, commissioning and maintaining the inverter. Advanced commissioning (this manual)

- EMC installation guideline  
<http://support.automation.siemens.com/WW/view/en/60612658>  
 EMC-compliant control cabinet design, potential equalization and cable routing

- "Safety Integrated" function manual  
<https://support.industry.siemens.com/cs/ww/en/view/109477367>  
 Configuring PROFIsafe. Installing, commissioning and operating fail-safe functions of the inverter.



- "Fieldbus" function manual  
<https://support.industry.siemens.com/cs/ww/en/view/109477369>  
 Configuring fieldbuses.

- CU240B/E-2 List Manual  
<https://support.industry.siemens.com/cs/ww/en/view/109477251>  
 Parameter list, alarms and faults. Graphic function diagrams

- BOP-2 operating instructions  
<https://support.industry.siemens.com/cs/ww/en/view/42185248>  
 Using the operator panel.

- IOP operating instructions  
<https://support.industry.siemens.com/cs/ww/en/view/109478559>  
 Using the operator panel. Mounting the door mounting kit for IOP.



- Power Module Installation Manual (<https://support.industry.siemens.com/cs/ww/en/ps/13224/man>)  
Installing Power Modules, reactors and filters. Technical data, maintenance  

- Accessories manual (<https://support.industry.siemens.com/cs/ww/en/ps/13225/man>)  
Installation descriptions for inverter components, e.g. line reactors and line filters. The printed installation descriptions are supplied together with the components.  

### Finding the most recent edition of a manual

If there are multiple editions of a manual, select the latest edition:

> Manual Fieldbus systems: PROFINET, PROFIBUS, EtherNet/IP, CANopen, USS, Bacnet, Modbus, P1 08/11/2014  
ID: 99685159  
★★★★☆ (3)

04/2014, FW V4.7.3 Function manual, A5E34229197B AA

For products: 6SL3544-0MB02-1PA0, 6SL3244-0BB13-1FA0, ... > All products

+ Versions of this manual

04/2015, FW V4.7.3

04/2015, FW V4.7.3

04/2014, FW V4.7.3

### Configuring a manual



Further information about the configurability of manuals is available in the Internet:



MyDocumentationManager (<https://www.industry.siemens.com/topics/global/en/planning-efficiency/documentation/Pages/default.aspx>).

Select "Display and configure" and add the manual to your "mySupport-documentation":

Function manual  
Function Manual  
**Article number of the documentation:** A5E34229197B AA  
**Description / topic** 04/2014, FW V4.7,

 Show and configure  
 Download (5644 KB)



**mySupport Cockpit**

**Actions / Options**

- > Add to mySupport favorites
- > Add to mySupport documentation
- > Fav

Not all manuals can be configured.

The configured manual can be exported in RTF, PDF or XML format.



## A.8.2 Configuring support

### Catalog



Ordering data and technical information for SINAMICS G inverters.



Catalog D31 for download or online catalog (Industry Mall):

Everything about SINAMICS G120 ([www.siemens.com/sinamics-g120](http://www.siemens.com/sinamics-g120))

### SIZER

The configuration tool for SINAMICS, MICROMASTER and DYNAVERT T drives, motor starters, as well as SINUMERIK, SIMOTION controllers and SIMATIC technology



SIZER on DVD:

Article number: 6SL3070-0AA00-0AG0



Download SIZER (<http://support.automation.siemens.com/WW/view/en/10804987/130000>)

### EMC (electromagnetic compatibility) technical overview



Standards and guidelines, EMC-compliant control cabinet design



EMC overview (<https://support.industry.siemens.com/cs/ww/en/view/103704610>)

### EMC Guidelines configuration manual



EMC-compliant control cabinet design, potential equalization and cable routing



EMC installation guideline (<http://support.automation.siemens.com/WW/view/en/60612658>)

### Safety Integrated for novices technical overview



Application examples for SINAMICS G drives with Safety Integrated



Safety Integrated for novices

(<https://support.industry.siemens.com/cs/ww/en/view/80561520>)

### A.8.3 Product Support



Additional information about the product and more is available in the Internet: Product support (<http://www.siemens.com/automation/service&support>).

This address provides the following:

- Actual product information (Update), FAQ (frequently asked questions), downloads.
- The Newsletter contains the latest information on the products you use.
- The Knowledge Manager (Intelligent Search) helps you find the documents you need.
- Users and specialists from around the world share their experience and knowledge in the Forum.
- You can find your local representative for Automation & Drives via our contact database under "Contact & Partner".
- Information about local service, repair, spare parts and much more can be found under "Services".

## A.9 Mistakes and improvements

If you come across any mistakes when reading this manual or if you have any suggestions for how it can be improved, then please send your suggestions to the following address or by E-mail:

Siemens AG  
Digital Factory  
Motion Control  
Postfach 3180  
91050 Erlangen, Germany

E-mail (<mailto:docu.motioncontrol@siemens.com>)

# Index

## 1

1FG1 geared synchronous motor without encoder, 49  
1FK7 synchronous motor without encoder, 49

## 8

87 Hz characteristic, 85, 85

## A

Acceptance test, 345, 345  
    Complete, 345  
    Reduced scope of, 346, 397  
    STO (basic functions), 503  
    Test scope, 346, 397  
Acceptance test record, 345  
Acyclic communication, 209  
Adjustable parameters, 485  
Agitators, 134, 143, 153, 158  
Alarm, 401, 405  
Alarm buffer, 405  
Alarm code, 405  
Alarm history, 406  
Alarm time, 405  
Alarm value, 405  
Ambient temperature, 270, 271  
Analog input, 95, 102  
    Function, 173, 180, 180, 184  
Analog output, 95, 102  
    Function, 173, 183  
Application  
    Reading and writing parameters cyclically via PROFIBUS, 209  
Automatic mode, 217  
Automatic restart, 300  
Autotuning, 312

## B

Base components, 58  
Base load, 428  
Base load input current, 428  
Base load output current, 428  
Base load power, 428

Basic functions, 176  
BF (Bus Fault), 402, 402, 403, 403  
BICO block, 495  
Bimetallic switch, 265  
Binector input, 174  
Binectors, 496  
Bit pattern test, 337  
Block, 495  
BOP-2  
    Installing, 131  
    Menu, 488  
    Symbols, 488  
Brake Relay, 86  
Braking  
    Regenerative, 292  
Braking functions, 283  
Braking method, 283, 284  
Braking module, 290  
Braking resistor, 45, 290  
Break loose torque, 486  
Bus fault, 403  
Bus termination, 91

## C

Catalog, 509  
CDS (Command Data Set), 217, 343, 344  
Centrifuge, 134, 143, 153, 158, 285, 288, 292  
Chain conveyors, 134, 143, 153, 158  
Characteristic  
    Additional, 240  
    Linear, 240, 241  
    parabolic, 240, 241  
    square-law, 240, 241  
Checklist  
    PROFIBUS, 123  
    PROFINET, 120  
Circuit diagram, 505  
Clockwise rotation, 185  
Closed-loop torque control, 260  
Command Data Set, 217  
Command source, 169  
    Selecting, 485  
Commissioning  
    Guidelines, 127  
Communication  
    Acyclic, 209  
    Cyclically, 193

- Compound braking, 288, 289
- Compressor, 134, 143, 153, 158
- Configuring support, 509
- Connectors, 496
- Consistency, 337
- Consistent signals, 337
- Contact bounce, 337
- Control mode, 486
- Control terminals, 95, 102
- Control Units, 27, 29
- Control word
  - Control word 1, 195, 211, 214
  - Control word 3, 198
- Control word 3 (STW3), 198
- Controlling the motor, 185
- Conveyor belt, 134, 143, 153, 158, 285
- Conveyor systems, 156
- Copy
  - Series commissioning, 346
- Copy parameters (series commissioning), 346
- Correction manual, 510
- Counter-clockwise rotation, 185
- Countersignatures, 505
- Crane, 295
- Crushers, 134, 143, 153, 158
- Current input, 178
- Current reduction, 468, 473
- Cyclic communication, 195

## D

- Data backup, 351, 357, 363, 367, 505
- Data set 47 (DS), 209
- Data set changeover, 343, 344
- Data transfer, 357, 363, 367
- DC braking, 198, 286, 286, 286, 286, 287
- DC-link overvoltage, 274
- DC-link voltage, 274
- Delta connection ( $\Delta$ ), 85, 128
- Derating
  - Installation altitude, 475
- DI (Digital Input), 176
- Digital input, 95, 102, 174, 185
  - Function, 173
- Digital inputs
  - Multiple assignment, 343
- Digital output, 95, 102
  - Function, 173, 177
- DIP switch
  - Analog input, 178
- Direct data exchange, 209
- Direction of rotation, 227, 227

- Direction reversal, 185
- Discrepancy, 337
  - Filter, 337
  - Tolerance time, 337
- Display parameters, 485
- Distance connector, 30
- Download, 357, 364, 367
- Drive Data Set, DDS, 348
- Drive Data Sets, 348
- Droop, 250
- Dynamic braking, 290

## E

- Electromechanical sensor, 499
- Elevator, 295
- EMC, 54
- Emergency Stop button, 329
- EN 61800-5-2, 328
- End customer, 504
- Energy recovery, 33
- Energy recovery option, 292
- Energy-saving display, 281
- Extended functions, 176
- Extruder, 134, 143, 153, 158, 264

## F

- Factory assignment, 95, 102
- Factory settings, 162
  - Restore to, 164
  - Restoring the, 162, 163, 166
- Fan, 32, 134, 143, 153, 158
- Fans, 156, 263
- Fault, 401, 408
  - Acknowledge, 408, 409
  - Motor, 399
- Fault buffer, 408
- Fault case, 408
- Fault code, 408
- Fault history, 409
- Fault time, 408
  - received, 408
  - removed, 408
- Fault value, 408
- FCC, 237
- F-DI (Fail-safe Digital Input), 176
- F-digital output module, 500
- FFC (Flux Current Control), 240
- Field weakening, 85
- Fieldbus interfaces, 91, 92, 118

- Filter
    - Contact bounce, 337
    - Discrepancy, 337
    - On/off test, 337
  - Firmware
    - Update, 397
  - Firmware downgrade, 394
  - Firmware
    - version, 377, 477, 478, 481, 482, 483, 485, 504
  - Flow control, 308
  - Flux current control, 237
  - Flying restart, 298
  - Forced dormant error detection, 339
    - setting, 340
  - Formatting, 352
  - Free function blocks, 326
  - Function Manual, 507
  - Function table, 504
  - Functional expansions, 346
  - Functions
    - BOP-2, 488
    - Overview, 169
    - Technological, 170
- G**
- Getting Started, 507
  - Grinding machine, 285, 288
  - GSDML (Generic Station Description Markup Language), 121
- H**
- Hardware Installation Manual, 507
  - High Overload, 428
  - Hoist drive, 292
  - Hoisting gear, 290, 295
  - Horizontal conveyors, 264, 288, 290
  - Hotline, 510
- I**
- I\_max controller, 273
  - I2t monitoring, 262
  - Inclined conveyors, 290
  - IND (page index), 203
  - Industry Mall, 509
  - Installation, 53, 53
  - Installation altitude, 475
  - Installing, 60
  - Interfaces, 91
- Interlock, 497
  - Inverter
    - does not respond, 398
    - Update, 397
  - Inverter components, 27, 377
  - Inverter control, 169
  - IT system, 77
- J**
- JOG function, 191
- K**
- Kinetic buffering, 304
  - Kneaders, 134, 143, 153, 158
  - Know-how protection, 352, 372
  - KTY84 sensor, 265
- L**
- LED
    - BF, 402, 402, 403, 403
    - LNK, 402
    - RDY, 402, 402
    - SAFE, 402
  - LED (light emitting diode), 401
  - Level control, 308
  - License, 352
  - Line contactor, 327
  - Line dip, 304
  - Line filter, 36, 37
  - Line supply cable, 84
  - Line supply type, 77
  - Linear characteristic, 240, 241
  - List Manual, 507
  - LNK (PROFINET Link), 402
  - Load failure, 318, 321
  - Low Overload, 428
- M**
- Machine description, 504
  - Main screen form (basic functions), 334, 335
  - Manual mode, 217
  - Manufacturer, 504
  - Maximum cable length
    - PROFIBUS, 124
  - Maximum cable lengths
    - PROFINET, 121

Maximum current controller, 273  
Maximum speed, 130, 227, 486  
MELD\_NAMUR (fault word according to the VIK-Namur definition), 200  
Memory cards, 29  
Menu  
    BOP-2, 488  
    Operator panel, 488  
Mills, 134, 143, 153, 158  
Minimum speed, 130, 227, 230, 486  
Mistakes manual, 510  
Mixers, 134, 143, 153, 158  
MMC (memory card), 352  
Moment of inertia estimator, 254  
MOP (motorized potentiometer), 222  
MotID (motor data identification), 137, 140, 144  
Motor cable, 84  
Motor control, 170  
Motor data, 128  
    Identify, 140, 248, 260  
    Identifying, 137, 144  
    measure, 140  
    measuring, 144  
    Measuring, 137  
Motor fault, 399  
Motor holding brake, 293, 293, 294, 295, 327  
Motor standard, 278  
Motor temperature sensor, 95, 102, 268  
Motorized potentiometer, 222  
Multiple assignment  
    Digital inputs, 343

## N

Neutral conductor, 77

## O

OFF1 command, 185  
OFF3 ramp-down time, 233  
ON command, 185  
On/off test, 337  
Operating instruction, 23  
Operating Instructions, 507  
Operating mode, 504  
Operation, 172  
Operator panel  
    BOP-2, 488  
    Installing, 131  
    Menu, 488  
Optimizing the closed-loop speed controller, 248

Order number, 27  
Overload, 273, 486  
Overview  
    Section, 24  
Overview of the functions, 169  
Overvoltage, 274, 274

## P

Page index, 203  
Parabolic characteristic, 240, 241  
Parameter channel, 200  
    IND, 203  
Parameter index, 203  
Parameter number, 203, 490  
Parameter types, 485  
Parameter value, 491  
Partial load operation, 474  
password, 330  
PELV, 423, 425  
PFH (Probability of failure per hour), 426  
PID controller, 308  
Plant description, 504  
PLC functionality, 497  
PLC program, 505  
Pole position, 259  
Pole position identification, 259  
Power distribution systems, 77  
Power failure, 300  
Power Module, 27  
Power on reset, 165  
Pre-control, 257  
Pressure control, 308  
Probe, 322  
Procedure, 23  
Process variables of the technology controller, 279  
PROFIBUS, 123  
PROFIdrive, 118  
PROFIenergy, 118  
PROFI-safe, 118  
Protection functions, 170  
Protective conductor, 77  
PT1000 sensor, 265  
PTC sensor, 265  
Pulse cancelation, 196  
Pulse enable, 196, 211, 214  
Pulse frequency, 263, 264, 468, 473, 487  
Pulse suppression, 211, 214  
Pump, 32, 134, 143, 153, 156, 158

**Q**

Questions, 510  
Quick stop, 171

**R**

Radio interference class, 36  
Ramp-down, 486  
Ramp-down time, 233, 235, 486  
    Scaling, 235  
Ramp-function generator, 227, 232  
Ramp-up, 486  
Rampup time,  
Ramp-up time  
    Scaling, 235  
RDY (Ready), 402, 402  
Ready, 172  
Ready to switch on, 172  
Regenerative feedback, 292  
Regenerative operation, 283  
Replacing  
    Control Unit, 397  
    Gearbox, 397  
    Hardware, 397  
    Motor, 397  
    Power Module, 397  
Reset  
    Parameter, 162, 163, 164, 166  
Reversing, 227  
Roller conveyors, 134, 143, 153, 158  
Rotary furnace, 134, 143, 153, 158  
Rounding, 233  
Rounding OFF3, 233

**S**

S7 communication, 118  
SAFE, 402  
Safe Brake Relay, 48, 86, 340  
Safety function, 170  
Safety relay, 500  
Safety-related input, 176  
Saw, 285, 288  
Scaling  
    Analog input, 179  
    Analog output, 182  
SD (memory card), 352  
    Formatting, 352  
    MMC, 352  
Self-test, 339  
Sensor (electromechanical), 499

Sequence control, 171  
Serial number, 504  
Series commissioning, 346, 351  
Setpoint processing, 169, 227  
Setpoint source, 169  
    Selecting, 220, 221, 222, 485  
Settling time, 134, 143, 153, 158  
Shield connection kit, 30  
Short-circuit monitoring, 266, 267  
Signal interconnection, 495  
Signal states, 402  
Sine-wave filter, 43  
SIZER, 509  
Skip frequency band, 181, 227  
Slip compensation, 237  
Speed  
    change with BOP-2, 488  
    Limiting, 227  
Speed control, 246  
Speed deviation, 318, 321  
Speed monitoring, 318, 321  
Spindle, 134, 143, 153, 158  
Square-law characteristic, 240, 241  
Star connection (Y), 85  
Startdrive, 330, 363  
Startdrive commissioning tool, 330  
Startdrive PC tool, 330  
STARTER, 330, 363  
    Download, 51, 51  
STARTER commissioning tool, 330  
STARTER PC tool, 330  
Starting characteristics  
    Optimization, 242, 244  
Starting current, 238  
State overview, 171  
Status word  
    Status word 1, 197  
    Status word 3, 199  
Status Word  
    Status word 1, 212, 215  
STO (Safe Torque Off), 327, 327  
    Acceptance test, 503  
    Selecting, 327  
Storage medium, 351  
STW1 (control word 1), 195, 211, 214  
Subindex, 203  
Suggestions for improvement manual, 510  
Support, 510  
Switch off  
    Motor, 171  
    OFF1 command, 171

- OFF2 command, 171
- OFF3 command, 171
- Switch on
  - Motor, 171
  - ON command, 171
- Switching on inhibited, 172, 196
- Switching over units, 276
- Switching-on a motor with BOP-2, 488
- Switch-off signal paths, 339
- Switch-on inhibit, 211, 214
- Symbols, 23
- System runtime, 404

## T

- Technical data
  - Control Unit, 423, 425
- Technology controller, 198, 279, 308
- Telegram
  - Extending, 206
- Temperature calculation, 269
- Temperature monitoring, 262, 269
- Temperature sensor, 95, 102
- Temperature switch, 265
- Terminal block, 115, 173
- Terminal strip
  - Factory setting, 95, 102
- Test signals, 337
- Three-wire control, 185, 185
- TN line system, 77
- Torque accuracy, 134, 143, 153, 158
- Trace function, 492
- TT line system, 77
- Two-wire control, 185, 185
- Type plate
  - Control Unit, 27
  - Power Module, 27

## U

- Unit system, 279
- Unwinders, 292
- Update (firmware), 397
- Upgrading the firmware, 392
- Upload, 353, 363, 367
- USB interface, 147
- Use for the intended purpose, 27
- User interfaces, 91

## V

- V/f characteristic, 237
- V/f control, 486
- VDC min controller, 304
- Vector control, 248, 260, 486
  - Sensorless, 246
- Version
  - Control Unit, 27
  - Firmware, 504
  - Hardware, 504
  - Power Module, 27
  - Safety function, 504
- Vertical conveyors, 290
- Voltage boost, 237, 238, 242, 244, 486
- Voltage input, 178

## W

- Winders, 292
- Wire breakage, 337
- Wire-break monitoring, 179, 266, 267
- Write protection, 370, 370

## Z

- Ziegler Nichols, 313
- ZSW1 (status word 1), 197, 212, 215
- ZSW3 (status word 3), 199





## Additional information

SINAMICS inverters:  
[www.siemens.com/sinamics](http://www.siemens.com/sinamics)

Safety Integrated:  
[www.siemens.com/safety-integrated](http://www.siemens.com/safety-integrated)

PROFINET:  
[www.siemens.com/profinet](http://www.siemens.com/profinet)

Siemens AG  
Digital Factory  
Motion Control  
Postfach 3180  
91050 ERLANGEN  
GERMANY

Subject to change without prior notice  
© Siemens AG 2010-2016

Scan the QR code  
for additional  
information about  
SINAMICS G120.

