

**SIEMENS**



# SINAMICS

## Low-voltage inverters SINAMICS G120

Built-in devices with CU230P-2, CU240B-2 and CU240E-2 Control Units

Wall/panel mounting devices with CU230P-2 Control Units

Getting Started

Edition

04/2014

Answers for industry.



# SIEMENS

## SINAMICS G120

### Converter with Control Units CU230P-2; CU240B-2; CU240E-2

Getting Started

<u>Fundamental safety instructions</u>	<b>1</b>
<u>Design of the frequency converter</u>	<b>2</b>
<u>Installing</u>	<b>3</b>
<u>Commissioning</u>	<b>4</b>
<u>Manuals and technical support</u>	<b>5</b>

Edition 04/2014, Firmware V4.7



04/2014

A5E32885834B AB

## Legal information

### Warning notice system

This manual contains notices you have to observe in order to ensure your personal safety, as well as to prevent damage to property. The notices referring to your personal safety are highlighted in the manual by a safety alert symbol, notices referring only to property damage have no safety alert symbol. These notices shown below are graded according to the degree of danger.

 <b>DANGER</b>
indicates that death or severe personal injury <b>will</b> result if proper precautions are not taken.
 <b>WARNING</b>
indicates that death or severe personal injury <b>may</b> result if proper precautions are not taken.
 <b>CAUTION</b>
indicates that minor personal injury can result if proper precautions are not taken.
<b>NOTICE</b>
indicates that property damage can result if proper precautions are not taken.

If more than one degree of danger is present, the warning notice representing the highest degree of danger will be used. A notice warning of injury to persons with a safety alert symbol may also include a warning relating to property damage.

### Qualified Personnel

The product/system described in this documentation may be operated only by **personnel qualified** for the specific task in accordance with the relevant documentation, in particular its warning notices and safety instructions. Qualified personnel are those who, based on their training and experience, are capable of identifying risks and avoiding potential hazards when working with these products/systems.

### Proper use of Siemens products

Note the following:

 <b>WARNING</b>
Siemens products may only be used for the applications described in the catalog and in the relevant technical documentation. If products and components from other manufacturers are used, these must be recommended or approved by Siemens. Proper transport, storage, installation, assembly, commissioning, operation and maintenance are required to ensure that the products operate safely and without any problems. The permissible ambient conditions must be complied with. The information in the relevant documentation must be observed.

### Trademarks

All names identified by ® are registered trademarks of Siemens AG. The remaining trademarks in this publication may be trademarks whose use by third parties for their own purposes could violate the rights of the owner.

### Disclaimer of Liability

We have reviewed the contents of this publication to ensure consistency with the hardware and software described. Since variance cannot be precluded entirely, we cannot guarantee full consistency. However, the information in this publication is reviewed regularly and any necessary corrections are included in subsequent editions.

# Table of contents

<b>1</b>	<b>Fundamental safety instructions</b> .....	<b>7</b>
1.1	General safety instructions .....	7
1.2	Safety instructions for electromagnetic fields (EMF) .....	11
1.3	Handling electrostatic sensitive devices (ESD) .....	11
1.4	Industrial security .....	12
1.5	Residual risks of power drive systems .....	13
<b>2</b>	<b>Design of the frequency converter</b> .....	<b>15</b>
<b>3</b>	<b>Installing</b> .....	<b>17</b>
3.1	Installing the Power Module .....	17
3.2	Snapping the Control Unit onto the Power Module .....	19
3.3	Installing Control Unit .....	20
3.3.1	CU230P-2 control unit .....	20
3.3.1.1	Interfaces at the front of the CU230P-2 .....	20
3.3.1.2	Terminal strips of the CU230P-2 .....	21
3.3.2	CU240B / CU240E Control Unit .....	23
3.3.2.1	Interfaces at the front of the CU240B-2 and CU240E-2 .....	23
3.3.2.2	Terminal strips on CU240B-2 Control Units .....	24
3.3.2.3	Terminal strips on CU240E-2 Control Units .....	26
3.3.3	Default settings of the terminal strip .....	28
3.3.4	Wiring the terminal strip .....	32
3.4	Connecting up the fieldbus .....	33
<b>4</b>	<b>Commissioning</b> .....	<b>35</b>
4.1	Tools to commission the converter .....	35
4.2	IOP Intelligent Operator Panel .....	36
4.3	Commissioning .....	38
4.3.1	Settings in the basic commissioning menu .....	39
4.3.2	Enable "Safe Torque Off" safety function .....	41
4.3.3	The most important parameters at a glance .....	42
<b>5</b>	<b>Manuals and technical support</b> .....	<b>47</b>
5.1	Manuals for your inverter .....	47
5.2	Product support .....	48

## Objective of these instructions

This Getting Started describes how you install an inverter and commission and operate it using the IOP operator panel.

The functions and properties of the IOP are described in detail in the "SINAMICS IOP" operating instructions and are only explained here to an extent that is necessary to understand the described functions.

### Additional information on SINAMICS G120

All manuals for the inverter can be downloaded from the Internet and are additionally available on DVD. See also Section: Manuals and technical support (Page 47).

## What is the meaning of the symbols in the manual?



An operating instruction starts here.



This concludes the operating instruction.

## Firmware upgrade and downgrade

Options for upgrading and downgrading the firmware can be found on the Internet at <http://support.automation.siemens.com/WW/view/de/67364620> (<http://support.automation.siemens.com/WW/news/en/67364620>).

## Transferring license terms of the OSS code to a PC

### Procedure



To transfer the OSS license terms from the inverter to a PC, proceed as follows:

1. Switch off the inverter power supply.
2. Insert an empty memory card into the card slot of the inverter. Also see Section:Installing Control Unit (Page 20)
3. Switch on the inverter power supply.
4. When you have switched on the power supply, wait 30 seconds.  
During this time, the inverter writes the "Read\_OSS.ZIP" file onto the memory card.
5. Switch off the inverter power supply.
6. Remove the card from the inverter.
7. Use a card reader and load the file to a PC.



You have then transferred the OSS license terms from the inverter to a PC.

# Fundamental safety instructions

## 1.1 General safety instructions



### DANGER

#### Danger to life due to live parts and other energy sources

Death or serious injury can result when live parts are touched.

- Only work on electrical devices when you are qualified for this job.
- Always observe the country-specific safety rules.

Generally, six steps apply when establishing safety:

1. Prepare for shutdown and notify all those who will be affected by the procedure.
2. Disconnect the machine from the supply.
  - Switch off the machine.
  - Wait until the discharge time specified on the warning labels has elapsed.
  - Check that it really is in a no-voltage condition, from phase conductor to phase conductor and phase conductor to protective conductor.
  - Check whether the existing auxiliary supply circuits are de-energized.
  - Ensure that the motors cannot move.
3. Identify all other dangerous energy sources, e.g. compressed air, hydraulic systems, or water.
4. Isolate or neutralize all hazardous energy sources by closing switches, grounding or short-circuiting or closing valves, for example.
5. Secure the energy sources against switching on again.
6. Ensure that the correct machine is completely interlocked.

After you have completed the work, restore the operational readiness in the inverse sequence.



### WARNING

#### Danger to life through a hazardous voltage when connecting an unsuitable power supply

Touching live components can result in death or severe injury.

- Only use power supplies that provide SELV (Safety Extra Low Voltage) or PELV- (Protective Extra Low Voltage) output voltages for all connections and terminals of the electronics modules.



**! WARNING**

**Danger to life when live parts are touched on damaged devices**

Improper handling of devices can cause damage.

For damaged devices, hazardous voltages can be present at the enclosure or at exposed components; if touched, this can result in death or severe injury.

- Ensure compliance with the limit values specified in the technical data during transport, storage and operation.
- Do not use any damaged devices.



**! WARNING**

**Danger to life through electric shock due to unconnected cable shields**

Hazardous touch voltages can occur through capacitive cross-coupling due to unconnected cable shields.

- As a minimum, connect cable shields and the conductors of power cables that are not used (e.g. brake cores) at one end at the grounded housing potential.



**! WARNING**

**Danger to life due to electric shock when not grounded**

For missing or incorrectly implemented protective conductor connection for devices with protection class I, high voltages can be present at open, exposed parts, which when touched, can result in death or severe injury.

- Ground the device in compliance with the applicable regulations.



**! WARNING**

**Danger to life due to electric shock when opening plug connections in operation**

When opening plug connections in operation, arcs can result in severe injury or death.

- Only open plug connections when the equipment is in a no-voltage state, unless it has been explicitly stated that they can be opened in operation.

**! WARNING**

**Danger to life due to fire spreading if housing is inadequate**

Fire and smoke development can cause severe personal injury or material damage.

- Install devices without a protective housing in a metal control cabinet (or protect the device by another equivalent measure) in such a way that contact with fire is prevented.
- Ensure that smoke can only escape via controlled and monitored paths.



 **WARNING**

**Danger to life through unexpected movement of machines when using mobile wireless devices or mobile phones**

Using mobile wireless devices or mobile phones with a transmit power > 1 W closer than approx. 2 m to the components may cause the devices to malfunction, influence the functional safety of machines therefore putting people at risk or causing material damage.

- Switch the wireless devices or mobile phones off in the immediate vicinity of the components.

 **WARNING**

**Danger to life due to the motor catching fire in the event of insulation overload**

There is higher stress on the motor insulation through a ground fault in an IT system. If the insulation fails, it is possible that death or severe injury can occur as a result of smoke and fire.

- Use a monitoring device that signals an insulation fault.
- Correct the fault as quickly as possible so the motor insulation is not overloaded.

 **WARNING**

**Danger to life due to fire if overheating occurs because of insufficient ventilation clearances**

Inadequate ventilation clearances can cause overheating of components with subsequent fire and smoke. This can cause severe injury or even death. This can also result in increased downtime and reduced service lives for devices/systems.

- Ensure compliance with the specified minimum clearance as ventilation clearance for the respective component.

 **WARNING**

**Danger of an accident occurring due to missing or illegible warning labels**

Missing or illegible warning labels can result in accidents involving death or serious injury.

- Check that the warning labels are complete based on the documentation.
- Attach any missing warning labels to the components, in the national language if necessary.
- Replace illegible warning labels.

**NOTICE**

**Device damage caused by incorrect voltage/insulation tests**

Incorrect voltage/insulation tests can damage the device.

- Before carrying out a voltage/insulation check of the system/machine, disconnect the devices as all converters and motors have been subject to a high voltage test by the manufacturer, and therefore it is not necessary to perform an additional test within the system/machine.



**WARNING**

**Danger to life when safety functions are inactive**

Safety functions that are inactive or that have not been adjusted accordingly can cause operational faults on machines that could lead to serious injury or death.

- Observe the information in the appropriate product documentation before commissioning.
- Carry out a safety inspection for functions relevant to safety on the entire system, including all safety-related components.
- Ensure that the safety functions used in your drives and automation tasks are adjusted and activated through appropriate parameterizing.
- Perform a function test.
- Only put your plant into live operation once you have guaranteed that the functions relevant to safety are running correctly.

**Note**

**Important safety notices for Safety Integrated functions**

If you want to use Safety Integrated functions, you must observe the safety notices in the Safety Integrated manuals.



**WARNING**

**Danger to life or malfunctions of the machine as a result of incorrect or changed parameterization**

As a result of incorrect or changed parameterization, machines can malfunction, which in turn can lead to injuries or death.

- Protect the parameterization (parameter assignments) against unauthorized access.
- Respond to possible malfunctions by applying suitable measures (e.g. EMERGENCY STOP or EMERGENCY OFF).

## 1.2 Safety instructions for electromagnetic fields (EMF)



### WARNING

#### **Danger to life from electromagnetic fields**

Electromagnetic fields (EMF) are generated by the operation of electrical power equipment such as transformers, converters or motors.

People with pacemakers or implants are at a special risk in the immediate vicinity of these devices/systems.

- Ensure that the persons involved are the necessary distance away (minimum 2 m).

## 1.3 Handling electrostatic sensitive devices (ESD)

Electrostatic sensitive devices (ESD) are individual components, integrated circuits, modules or devices that may be damaged by either electric fields or electrostatic discharge.



### NOTICE

#### **Damage through electric fields or electrostatic discharge**

Electric fields or electrostatic discharge can cause malfunctions through damaged individual components, integrated circuits, modules or devices.

- Only pack, store, transport and send electronic components, modules or devices in their original packaging or in other suitable materials, e.g. conductive foam rubber or aluminum foil.
- Only touch components, modules and devices when you are grounded by one of the following methods:
  - Wearing an ESD wrist strap
  - Wearing ESD shoes or ESD grounding straps in ESD areas with conductive flooring
- Only place electronic components, modules or devices on conductive surfaces (table with ESD surface, conductive ESD foam, ESD packaging, ESD transport container).

## 1.4 Industrial security

### Note

#### Industrial security

Siemens provides products and solutions with industrial security functions that support the secure operation of plants, solutions, machines, equipment and/or networks. They are important components in a holistic industrial security concept. With this in mind, Siemens' products and solutions undergo continuous development. Siemens recommends strongly that you regularly check for product updates.

For the secure operation of Siemens products and solutions, it is necessary to take suitable preventive action (e.g. cell protection concept) and integrate each component into a holistic, state-of-the-art industrial security concept. Third-party products that may be in use should also be considered. For more information about industrial security, visit Hotspot-Text (<http://www.siemens.com/industrialsecurity>).

To stay informed about product updates as they occur, sign up for a product-specific newsletter. For more information, visit Hotspot-Text (<http://support.automation.siemens.com>).

### WARNING

#### **Danger as a result of unsafe operating states resulting from software manipulation**

Software manipulation (e.g. by viruses, Trojan horses, malware, worms) can cause unsafe operating states to develop in your installation which can result in death, severe injuries and/or material damage.

- Keep the software up to date.  
You will find relevant information and newsletters at this address (<http://support.automation.siemens.com>).
- Incorporate the automation and drive components into a holistic, state-of-the-art industrial security concept for the installation or machine.  
You will find further information at this address (<http://www.siemens.com/industrialsecurity>).
- Make sure that you include all installed products into the holistic industrial security concept.

## 1.5 Residual risks of power drive systems

The control and drive components of a drive system are approved for industrial and commercial use in industrial line supplies. Their use in public line supplies requires a different configuration and/or additional measures.

These components may only be operated in closed housings or in higher-level control cabinets with protective covers that are closed, and when all of the protective devices are used.

These components may only be handled by qualified and trained technical personnel who are knowledgeable and observe all of the safety instructions on the components and in the associated technical user documentation.

When assessing the machine's risk in accordance with the respective local regulations (e.g., EC Machinery Directive), the machine manufacturer must take into account the following residual risks emanating from the control and drive components of a drive system:

1. Unintentional movements of driven machine components during commissioning, operation, maintenance, and repairs caused by, for example,
  - Hardware and/or software errors in the sensors, control system, actuators, and cables and connections
  - Response times of the control system and of the drive
  - Operation and/or environmental conditions outside the specification
  - Condensation/conductive contamination
  - Parameterization, programming, cabling, and installation errors
  - Use of wireless devices/mobile phones in the immediate vicinity of the control system
  - External influences/damage
2. In the event of a fault, exceptionally high temperatures, including an open fire, as well as emissions of light, noise, particles, gases, etc. can occur inside and outside the inverter, e.g.:
  - Component failure
  - Software errors
  - Operation and/or environmental conditions outside the specification
  - External influences/damage

Inverters of the Open Type/IP20 degree of protection must be installed in a metal control cabinet (or protected by another equivalent measure) such that contact with fire inside and outside the inverter is not possible.

*1.5 Residual risks of power drive systems*

3. Hazardous shock voltages caused by, for example,
  - Component failure
  - Influence during electrostatic charging
  - Induction of voltages in moving motors
  - Operation and/or environmental conditions outside the specification
  - Condensation/conductive contamination
  - External influences/damage
4. Electrical, magnetic and electromagnetic fields generated in operation that can pose a risk to people with a pacemaker, implants or metal replacement joints, etc., if they are too close
5. Release of environmental pollutants or emissions as a result of improper operation of the system and/or failure to dispose of components safely and correctly

---

**Note**

The components must be protected against conductive contamination (e.g. by installing them in a control cabinet with degree of protection IP54 according to IEC 60529 or NEMA 12).

Assuming that conductive contamination at the installation site can definitely be excluded, a lower degree of cabinet protection may be permitted.

---

For more information about residual risks of the components in a drive system, see the relevant sections in the technical user documentation.

# 2

## Design of the frequency converter

### Main components of the inverter

Each SINAMICS G120 inverter comprises a Control Unit and a Power Module.

- The Control Unit controls and monitors the Power Module and the connected motor.
- The Power Modules are available for motors with a power range of between 0.37 kW and 250 kW.

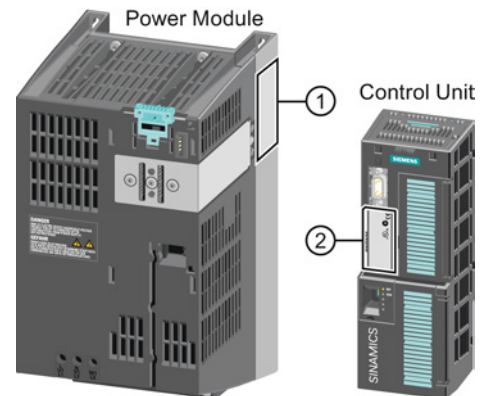

The following data is provided on the Power Module type plate (①):

- Designation: e.g. Power Module 240
- Technical data: Voltage and current
- Order number: e.g. 6SL3224-0BE13-7UA0
- Version: e.g. A02

The following data can be found on the Control Unit type plate (②):

- Designation: e.g. Control Unit CU240E-2 DP-F
- Order number: e.g. 6SL3244-0BB13-1PA0
- Version: e.g. A02 (hardware)

### With which Power Modules is it permissible to operate the Control Unit?

Power Module	✓ = operation with Power Module permissible, --- = not permissible		
	CU230P-2	CU240B-2	CU240E-2
PM340 1AC	---	---	✓
PM230 IP20 and push-through	✓	✓	✓
PM230 IP55	✓	---	---
PM240	✓	✓	✓
PM240-2	✓	✓	✓
PM250, IP20	✓	✓	✓
PM260, IP20	✓	✓	✓
PM330, IP20	✓	---	---

### Additional inverter components

Accessories are available for the inverter, e.g. reactors, filters and operator panels (Basic Operator Panel BOP-2 or Intelligent Operator Panel IOP).

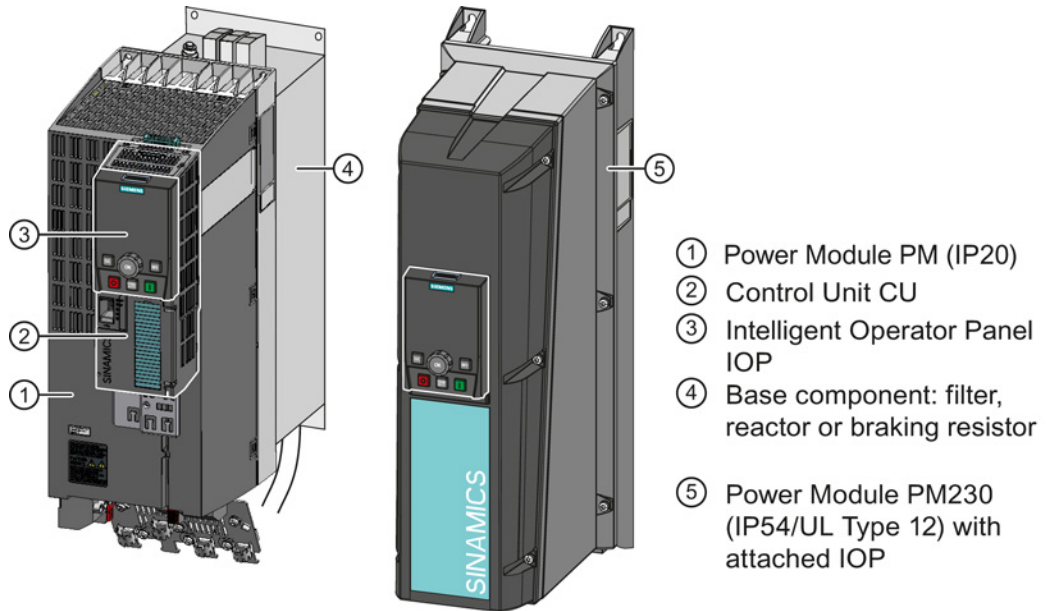

Figure 2-1 Design of the inverter (example)

You can find additional information about the inverter accessories in the attached component documentation and in the operating instructions.

---

#### Note

##### Inverters with IP55 degree of protection

In order to comply with degree of protection IP55, the inverter must be operated either with an Operator Panel (IOP or BOP-2) or with dummy cover 6SL3256-1BA00-0AA0.

---



## Installing

### 3.1 Installing the Power Module

#### Connecting the Power Module to the motor and line supply

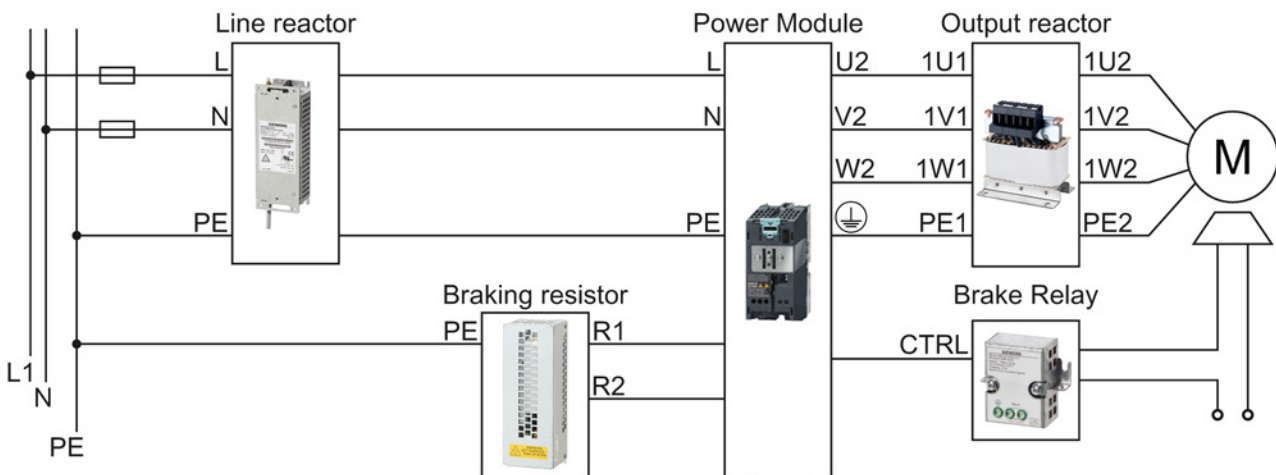

Figure 3-1 Connecting the PM340 1AC Power Module

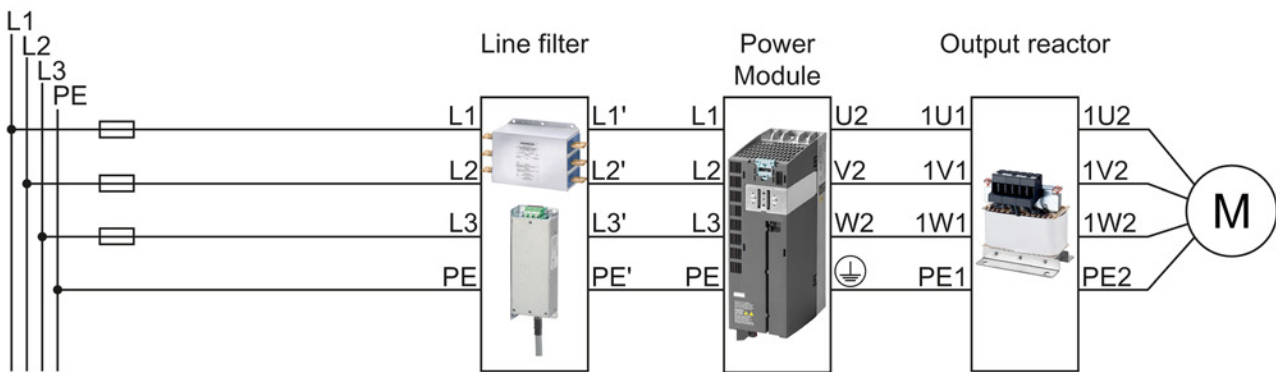

Figure 3-2 Connecting the PM230 IP20 and push-through Power Module

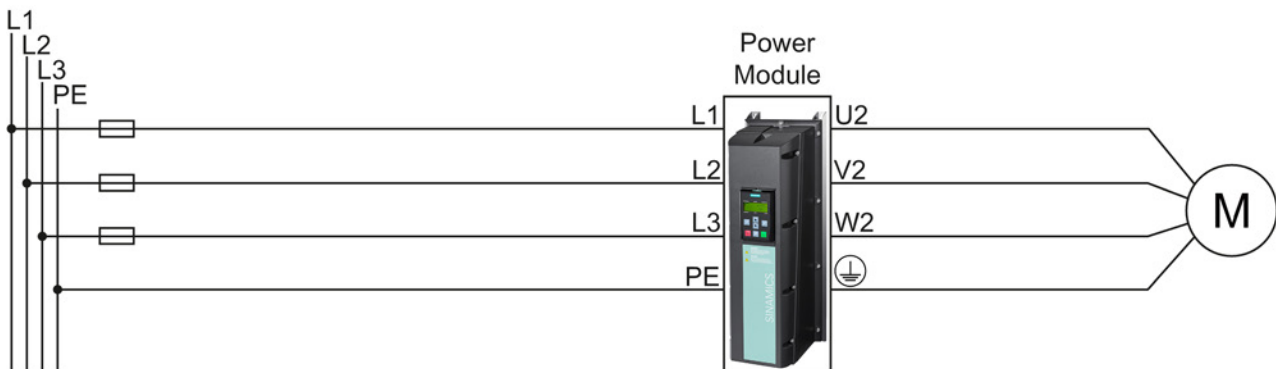

Figure 3-3 Connecting the PM230 IP55 Power Module

3.1 Installing the Power Module

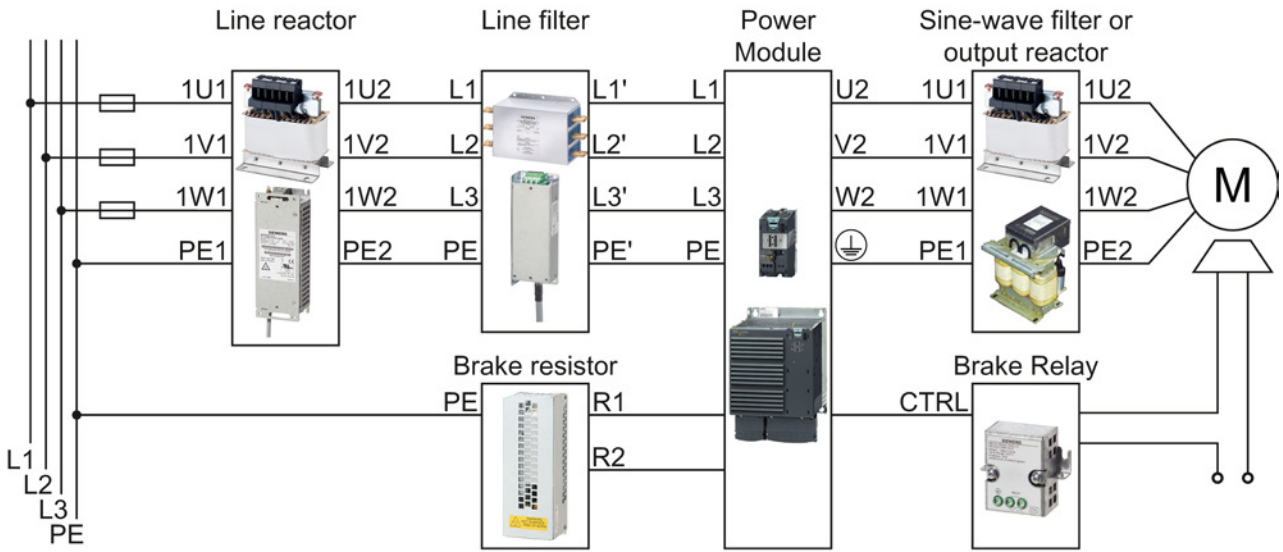

Figure 3-4 Connecting the PM240, PM240-2 IP20 and push-through Power Module

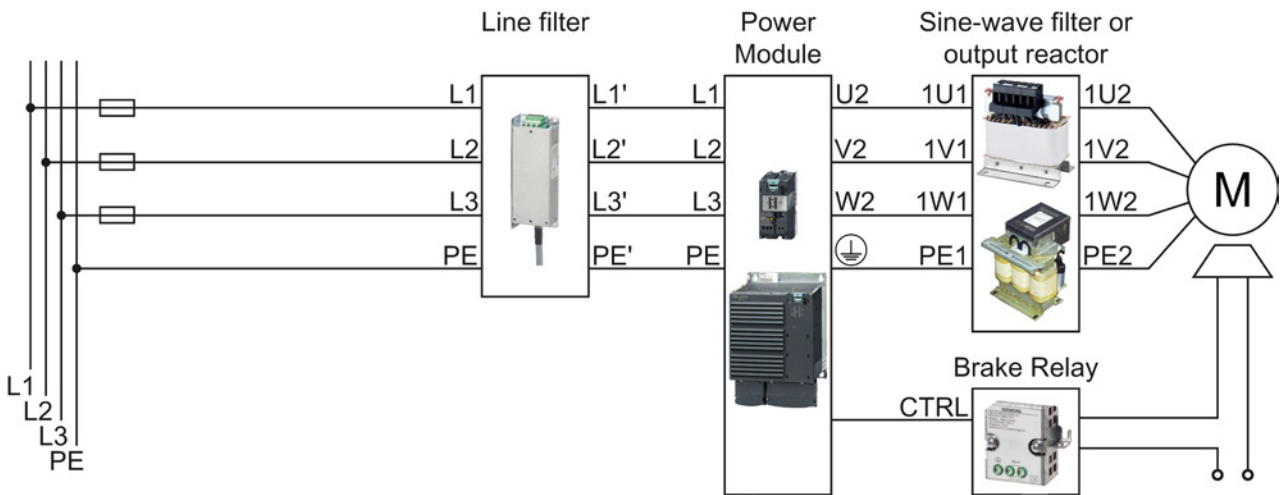

Figure 3-5 Connecting the PM250 Power Module

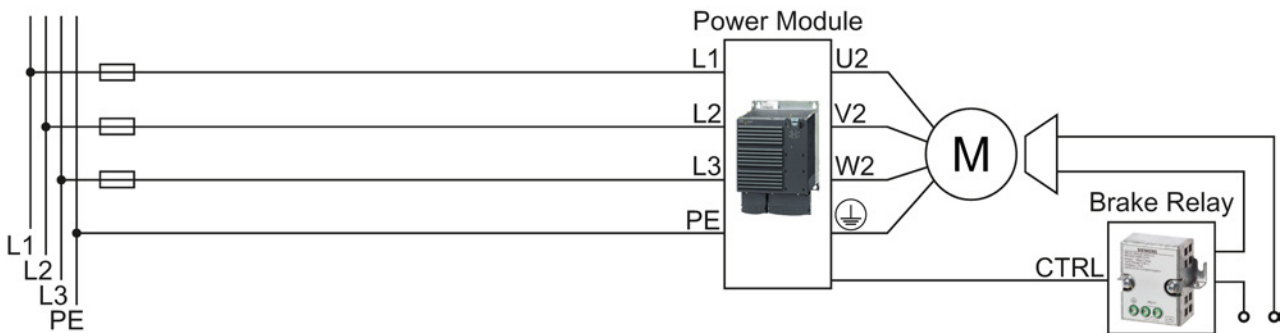

Figure 3-6 Connecting the PM260 Power Module

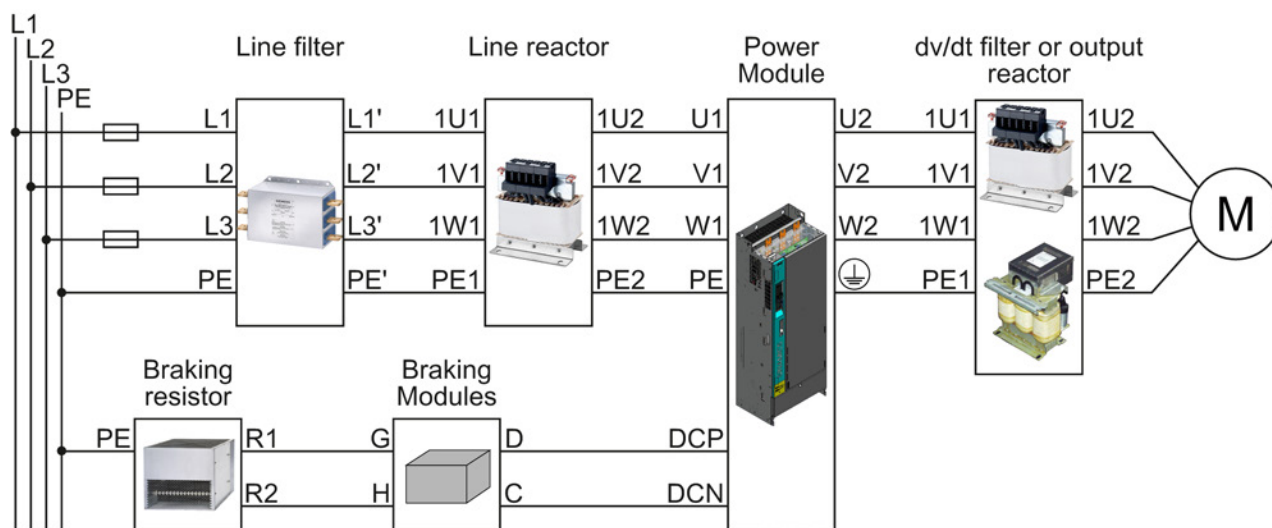
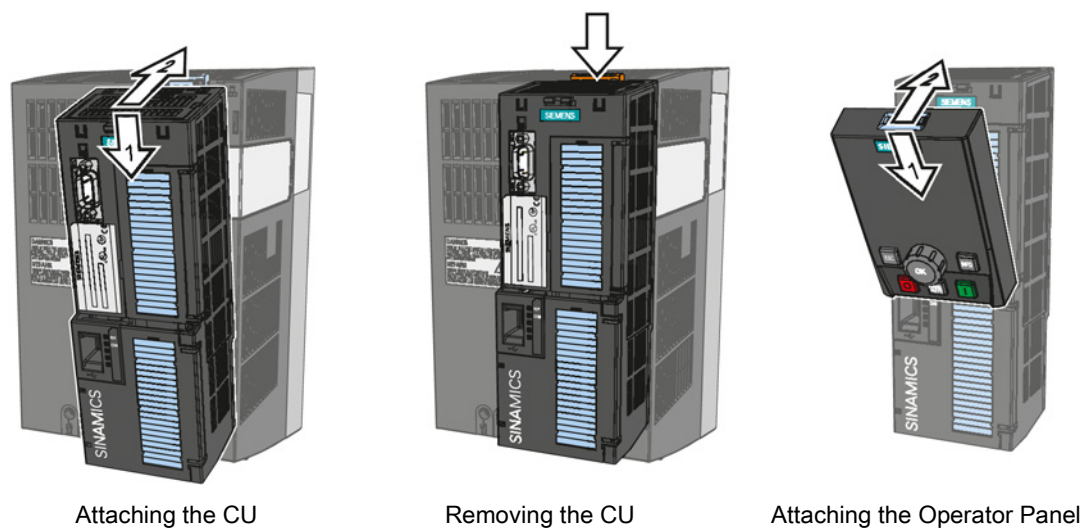

Figure 3-7 Connecting the PM330 Power Module

### 3.2 Snapping the Control Unit onto the Power Module



### 3.3 Installing Control Unit

#### 3.3.1 CU230P-2 Control Unit

##### 3.3.1.1 Interfaces at the front of the CU230P-2

#### Interfaces at the front of the Control Unit

To access the interfaces at the front of the Control Unit, you must lift the Operator Panel (if one is being used) and open the front doors.

① Memory card slot

② Selecting the fieldbus address:

- CU230P-2 DP
- CU230P-2 CAN
- CU230P-2 HVAC
- CU230P-2 BT

Bit 6 (64)	■
Bit 5 (32)	■
Bit 4 (16)	■
Bit 3 (8)	■
Bit 2 (4)	■
Bit 1 (2)	■
Bit 0 (1)	■
On	Off

③ Terminal strips

④ Fieldbus interfaces at the lower side

⑤ Terminal strips for the digital outputs

⑥ Status LED

■	RDY
■	BF
---	---
■	LNK1 (PROFINET)
■	LNK2 (PROFINET)

⑦ USB interface for connection to a PC

⑧ Switch for AI0 and AI1 (U/I)

AI1	■
AI0	■
I	U

- I 0/4 mA ... 20 mA
- U -10/0 V ... 10 V

⑨ Switch for AI2 (current/temperature)

Temp	I
------	---

⑩ Connection to the operator panel

## 3.3.1.2 Terminal strips of the CU230P-2

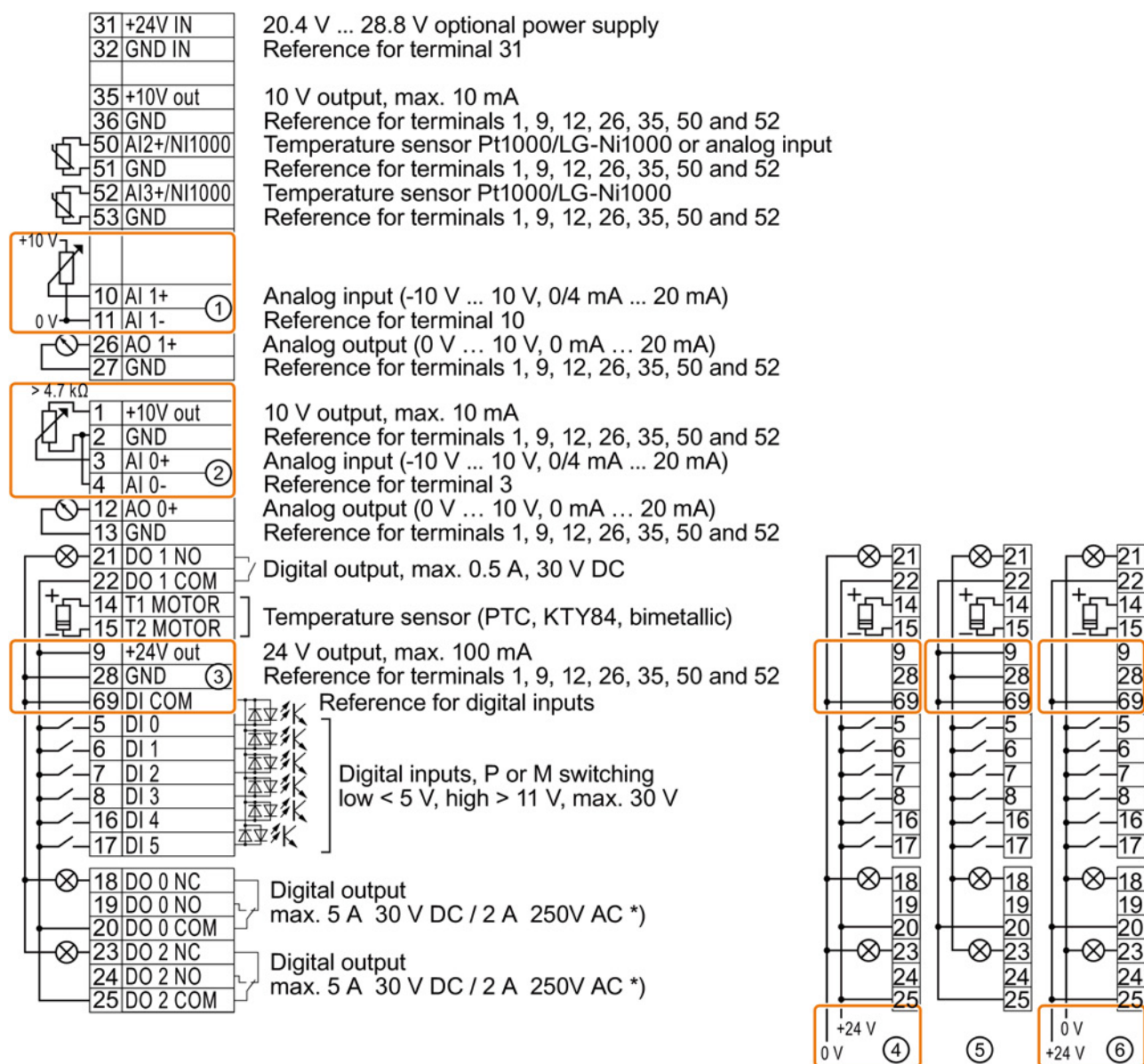



\*) The following applies to systems complying with UL: A maximum of 3 A 30 V DC or 2 A 250 V AC may be connected via terminals 18 / 20 (DO 0 NC) and 23 / 25 (DO 2 NC).

- ① The analog input is supplied from an external 10 V voltage.
- ② The analog input is supplied from the internal 10 V voltage.
- ③ Wiring when using the internal power supplies. Connecting a contact switching to P.
- ④ Wiring when using external power supplies. Connecting a contact switching to P.
- ⑤ Wiring when using the internal power supplies. Connecting a contact switching to M.
- ⑥ Wiring when using external power supplies. Connecting a contact switching to M.



**Factory setting**

The factory setting of the terminals depends on whether the Control Unit has a PROFIBUS / PROFINET interface.

Factory setting of the terminals for Control Units without PROFIBUS interface	Factory setting of the terminals for Control Units with PROFIBUS interface
<p>Fieldbus interface is not active.</p>	<p>Fieldbus interface depends on DI 3.</p> <p style="text-align: center;">     </p> <p style="text-align: center;">             Inverter receives control signals via PROFIdrive telegram 1   Fieldbus interface is not active         </p>

**Changing the function of terminals**

The function of every color-coded terminal can be set.

In order that you do not have to successively change terminal for terminal, several terminals can be jointly set using default settings.

The factory settings described above for USS and PROFIBUS/PROFINET terminals correspond to default setting 12 (two-wire control using method 1) or default setting 7 (switchover between fieldbus and jog using DI 3).

See also: Default settings of the terminal strip (Page 28).

## 3.3.2 CU240B / CU240E Control Unit

### 3.3.2.1 Interfaces at the front of the CU240B-2 and CU240E-2

#### Interfaces at the front of the Control Unit

To access the interfaces at the front of the Control Unit, you must lift the Operator Panel (if one is being used) and open the front doors.

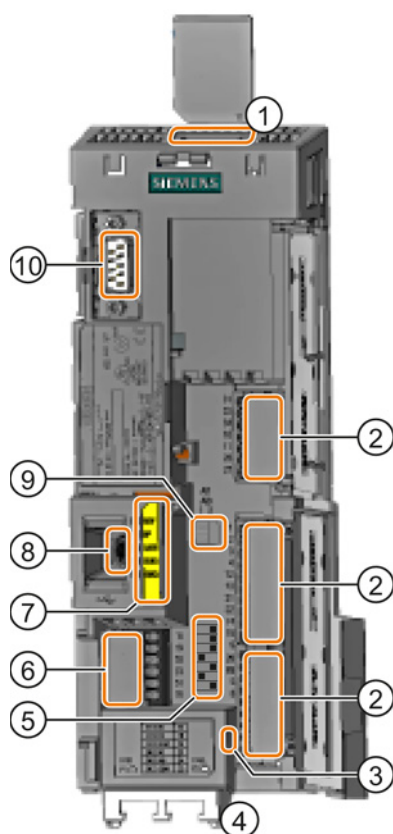

① Memory card slot

② Terminal strips

③ Depending on the fieldbus:

- USS, Modbus: Bus termination
- PROFIBUS, PROFINET, EtherNet/IP: No function

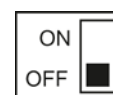

④ Fieldbus interfaces at the lower side

⑤ Selecting the fieldbus address:

- CU230P-2 DP
- CU230P-2 CAN
- CU230P-2 HVAC
- CU230P-2 BT

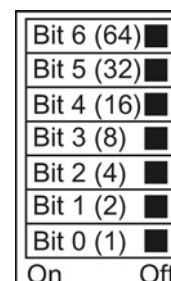

⑥ Terminal strips for the digital outputs

⑦ Status LED

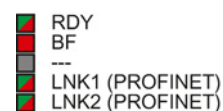

⑧ USB interface for connection to a PC

⑨ Switch for AI0 and AI1 (U/I)

- I 0/4 mA ... 20 mA
- U -10/0 V ... 10 V

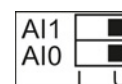

⑩ Connection to the operator panel

3.3.2.2 Terminal strips on CU240B-2 Control Units

31 +24V IN	20.4 V ... 28.8 V optional power supply
32 GND IN	Reference for terminal 31

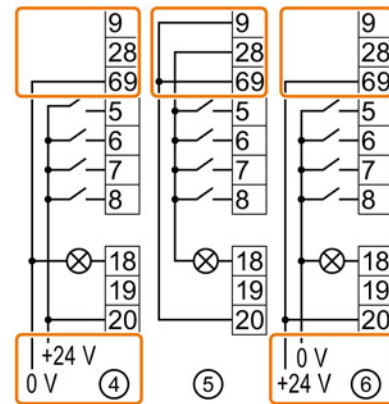
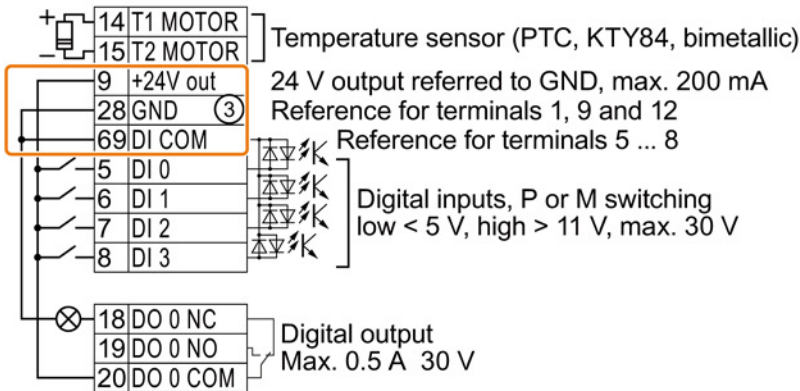
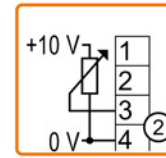
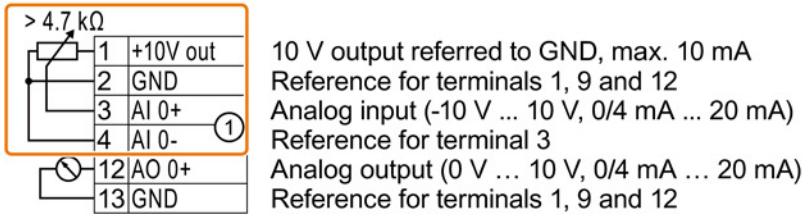

- ① The analog input is supplied from the internal 10 V voltage.
- ② The analog input is supplied from an external 10 V voltage.
- ③ Wiring when using the internal power supplies. Connection of a contact switching to P potential.
- ④ Wiring when using external power supplies. Connection of a contact switching to P potential.
- ⑤ Wiring when using the internal power supplies. Connection of a contact switching to M potential.
- ⑥ Wiring when using external power supplies. Connection of a contact switching to M potential.



### Factory setting of the CU240B-2

The factory setting of the terminals depends on whether the Control Unit has a PROFIBUS / PROFINET interface.

Factory setting of the terminals for Control Units without PROFIBUS interface	Factory setting of the terminals for Control Units with PROFIBUS interface
<p>Fieldbus interface is not active.</p>	<p>The function of the fieldbus interface depends on DI 3.</p>

3.3.2.3 Terminal strips on CU240E-2 Control Units

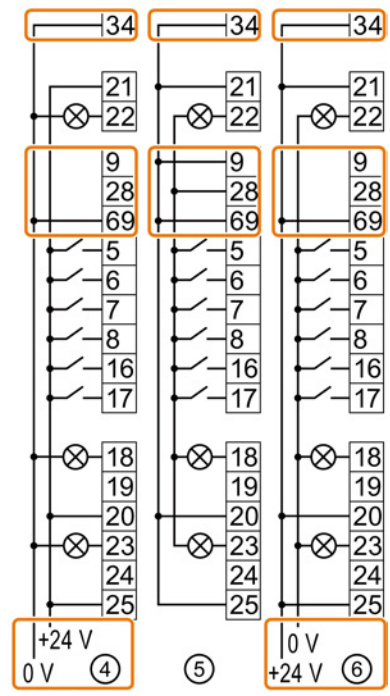
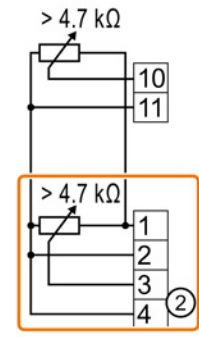
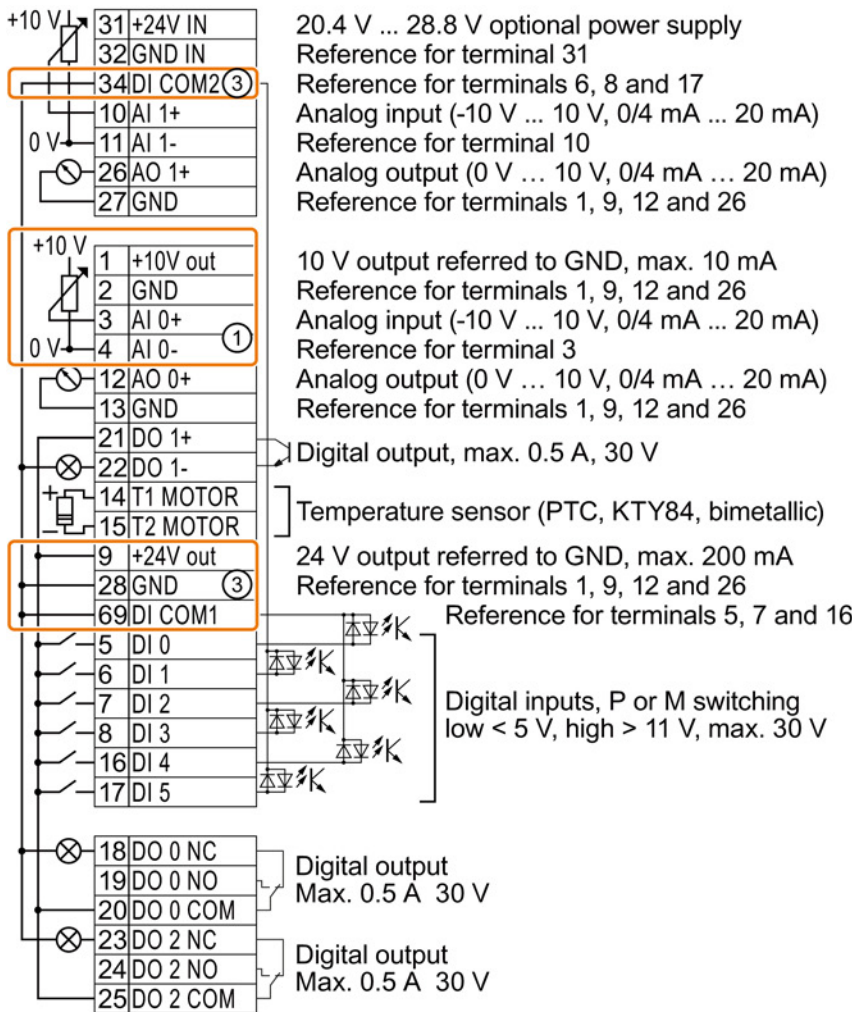

- ① The analog inputs are supplied from an external 10 V source.
- ② The analog inputs are supplied from the internal 10 V voltage.
- ③ Wiring when using the internal power supplies. Connecting a contact switching to P.
- ④ Wiring when using external power supplies. Connecting a contact switching to P.
- ⑤ Wiring when using the internal power supplies. Connecting a contact switching to M.
- ⑥ Wiring when using external power supplies. Connecting a contact switching to M.

### Factory setting of the CU240E-2

The factory setting of the terminals depends on whether the Control Unit has a PROFIBUS / PROFINET interface.

Factory setting of the terminals for Control Units without PROFIBUS interface	Factory setting of the terminals for Control Units with PROFIBUS interface
<p>Fieldbus interface is not active.</p>	<p>The function of the fieldbus interface depends on DI 3.</p>

### Changing the function of terminals

The function of every color-coded terminal can be set.

In order that you do not have to successively change terminal for terminal, several terminals can be jointly set using default settings.

3.3 Installing Control Unit

The factory settings described above for USS and PROFIBUS/PROFINET terminals correspond to default setting 12 (two-wire control using method 1) or default setting 7 (switchover between fieldbus and jog using DI 3).

See also: Default settings of the terminal strip (Page 28).

3.3.3 Default settings of the terminal strip

<p><b>Default setting 1: Two fixed speeds</b> <b>Control Units CU240E-2</b></p> <p>Selected with</p> <ul style="list-style-type: none"> <li>STARTER: Conveyor technology with 2 fixed frequencies</li> <li>BOP-2: coN 2 SP</li> </ul>	<p><b>Default setting 2: Two fixed speeds with safety function</b> <b>Control Units CU240E-2</b></p> <p>Selected with</p> <ul style="list-style-type: none"> <li>STARTER: Conveyor systems with Basic Safety</li> <li>BOP-2: coN SAFE</li> </ul>	<p><b>Default setting 3: Four fixed speeds</b> <b>Control Units CU240E-2</b></p> <p>Selected with</p> <ul style="list-style-type: none"> <li>STARTER: Conveyor technology with 4 fixed frequencies</li> <li>BOP-2: coN 4 SP</li> </ul>																																																																							
<p>Fieldbus interface is not active.</p> <table border="1" data-bbox="121 925 213 987"> <tr><td>3</td><td>AI 0</td><td>---</td></tr> <tr><td>4</td><td></td><td></td></tr> </table> <table border="1" data-bbox="121 994 547 1173"> <tr><td>5</td><td>DI 0</td><td>ON/OFF1 clockwise</td></tr> <tr><td>6</td><td>DI 1</td><td>ON / OFF1 counter-clockwise</td></tr> <tr><td>7</td><td>DI 2</td><td>Acknowledge</td></tr> <tr><td>8</td><td>DI 3</td><td>---</td></tr> <tr><td>16</td><td>DI 4</td><td>Fixed speed 3</td></tr> <tr><td>17</td><td>DI 5</td><td>Fixed speed 4</td></tr> </table> <p>DI 4 and DI 5 = high: The inverter adds both fixed speeds.</p>	3	AI 0	---	4			5	DI 0	ON/OFF1 clockwise	6	DI 1	ON / OFF1 counter-clockwise	7	DI 2	Acknowledge	8	DI 3	---	16	DI 4	Fixed speed 3	17	DI 5	Fixed speed 4	<p>Fieldbus interface is not active.</p> <table border="1" data-bbox="568 925 660 987"> <tr><td>3</td><td>AI 0</td><td>---</td></tr> <tr><td>4</td><td></td><td></td></tr> </table> <table border="1" data-bbox="568 994 911 1200"> <tr><td>5</td><td>DI 0</td><td>ON / OFF1 fixed speed 1</td></tr> <tr><td>6</td><td>DI 1</td><td>Fixed speed 2</td></tr> <tr><td>7</td><td>DI 2</td><td>Acknowledge</td></tr> <tr><td>8</td><td>DI 3</td><td>---</td></tr> <tr><td>16</td><td>DI 4</td><td rowspan="2">Reserved for safety function</td></tr> <tr><td>17</td><td>DI 5</td></tr> </table>	3	AI 0	---	4			5	DI 0	ON / OFF1 fixed speed 1	6	DI 1	Fixed speed 2	7	DI 2	Acknowledge	8	DI 3	---	16	DI 4	Reserved for safety function	17	DI 5	<p>Fieldbus interface is not active.</p> <table border="1" data-bbox="1015 925 1107 987"> <tr><td>3</td><td>AI 0</td><td>---</td></tr> <tr><td>4</td><td></td><td></td></tr> </table> <table border="1" data-bbox="1015 994 1262 1200"> <tr><td>5</td><td>DI 0</td><td>ON / OFF1 fixed speed 1</td></tr> <tr><td>6</td><td>DI 1</td><td>Fixed speed 2</td></tr> <tr><td>7</td><td>DI 2</td><td>Acknowledge</td></tr> <tr><td>8</td><td>DI 3</td><td>---</td></tr> <tr><td>16</td><td>DI 4</td><td>Fixed speed 3</td></tr> <tr><td>17</td><td>DI 5</td><td>Fixed speed 4</td></tr> </table> <p>Multiple DIs = high: The inverter adds the corresponding fixed speeds.</p>	3	AI 0	---	4			5	DI 0	ON / OFF1 fixed speed 1	6	DI 1	Fixed speed 2	7	DI 2	Acknowledge	8	DI 3	---	16	DI 4	Fixed speed 3	17	DI 5	Fixed speed 4
3	AI 0	---																																																																							
4																																																																									
5	DI 0	ON/OFF1 clockwise																																																																							
6	DI 1	ON / OFF1 counter-clockwise																																																																							
7	DI 2	Acknowledge																																																																							
8	DI 3	---																																																																							
16	DI 4	Fixed speed 3																																																																							
17	DI 5	Fixed speed 4																																																																							
3	AI 0	---																																																																							
4																																																																									
5	DI 0	ON / OFF1 fixed speed 1																																																																							
6	DI 1	Fixed speed 2																																																																							
7	DI 2	Acknowledge																																																																							
8	DI 3	---																																																																							
16	DI 4	Reserved for safety function																																																																							
17	DI 5																																																																								
3	AI 0	---																																																																							
4																																																																									
5	DI 0	ON / OFF1 fixed speed 1																																																																							
6	DI 1	Fixed speed 2																																																																							
7	DI 2	Acknowledge																																																																							
8	DI 3	---																																																																							
16	DI 4	Fixed speed 3																																																																							
17	DI 5	Fixed speed 4																																																																							
<p><b>Default setting 4: PROFIBUS or PROFINET</b> <b>Control Units CU240E-2</b></p> <p>Selected with</p> <ul style="list-style-type: none"> <li>STARTER: Conveyor systems with fieldbus</li> <li>BOP2: coN Fb</li> </ul>	<p><b>Default setting 5: PROFIBUS or PROFINET with safety function</b> <b>Control Units CU240E-2</b></p> <p>Selected with</p> <ul style="list-style-type: none"> <li>STARTER: Conveyor systems with fieldbus and Basic Safety</li> <li>BOP-2: coN Fb S</li> </ul>	<p><b>Default setting 6: PROFIBUS or PROFINET with two safety functions</b> <b>CU240E-2 F, CU240E-2 DP-F, and CU240E-2 PN-F Control Units</b></p> <p>Selected with</p> <ul style="list-style-type: none"> <li>STARTER: Fieldbus with Extended Safety</li> <li>BOP-2: Fb SAFE</li> </ul>																																																																							
<p>PROFIdrive telegram 352</p> <table border="1" data-bbox="121 1635 213 1697"> <tr><td>3</td><td>AI 0</td><td>---</td></tr> <tr><td>4</td><td></td><td></td></tr> </table> <table border="1" data-bbox="121 1704 376 1883"> <tr><td>5</td><td>DI 0</td><td>---</td></tr> <tr><td>6</td><td>DI 1</td><td>---</td></tr> <tr><td>7</td><td>DI 2</td><td>Acknowledge</td></tr> <tr><td>8</td><td>DI 3</td><td>---</td></tr> <tr><td>16</td><td>DI 4</td><td>---</td></tr> <tr><td>17</td><td>DI 5</td><td>---</td></tr> </table>	3	AI 0	---	4			5	DI 0	---	6	DI 1	---	7	DI 2	Acknowledge	8	DI 3	---	16	DI 4	---	17	DI 5	---	<p>PROFIdrive telegram 352</p> <table border="1" data-bbox="568 1635 660 1697"> <tr><td>3</td><td>AI 0</td><td>---</td></tr> <tr><td>4</td><td></td><td></td></tr> </table> <table border="1" data-bbox="568 1704 911 1883"> <tr><td>5</td><td>DI 0</td><td>---</td></tr> <tr><td>6</td><td>DI 1</td><td>---</td></tr> <tr><td>7</td><td>DI 2</td><td>Acknowledge</td></tr> <tr><td>8</td><td>DI 3</td><td>---</td></tr> <tr><td>16</td><td>DI 4</td><td rowspan="2">Reserved for safety function</td></tr> <tr><td>17</td><td>DI 5</td></tr> </table>	3	AI 0	---	4			5	DI 0	---	6	DI 1	---	7	DI 2	Acknowledge	8	DI 3	---	16	DI 4	Reserved for safety function	17	DI 5	<p>PROFIdrive telegram 1</p> <table border="1" data-bbox="1015 1635 1107 1697"> <tr><td>3</td><td>AI 0</td><td>---</td></tr> <tr><td>4</td><td></td><td></td></tr> </table> <table border="1" data-bbox="1015 1704 1358 1883"> <tr><td>5</td><td>DI 0</td><td rowspan="2">Reserved for safety function 1</td></tr> <tr><td>6</td><td>DI 1</td></tr> <tr><td>7</td><td>DI 2</td><td>Acknowledge</td></tr> <tr><td>8</td><td>DI 3</td><td>---</td></tr> <tr><td>16</td><td>DI 4</td><td rowspan="2">Reserved for safety function 2</td></tr> <tr><td>17</td><td>DI 5</td></tr> </table>	3	AI 0	---	4			5	DI 0	Reserved for safety function 1	6	DI 1	7	DI 2	Acknowledge	8	DI 3	---	16	DI 4	Reserved for safety function 2	17	DI 5		
3	AI 0	---																																																																							
4																																																																									
5	DI 0	---																																																																							
6	DI 1	---																																																																							
7	DI 2	Acknowledge																																																																							
8	DI 3	---																																																																							
16	DI 4	---																																																																							
17	DI 5	---																																																																							
3	AI 0	---																																																																							
4																																																																									
5	DI 0	---																																																																							
6	DI 1	---																																																																							
7	DI 2	Acknowledge																																																																							
8	DI 3	---																																																																							
16	DI 4	Reserved for safety function																																																																							
17	DI 5																																																																								
3	AI 0	---																																																																							
4																																																																									
5	DI 0	Reserved for safety function 1																																																																							
6	DI 1																																																																								
7	DI 2	Acknowledge																																																																							
8	DI 3	---																																																																							
16	DI 4	Reserved for safety function 2																																																																							
17	DI 5																																																																								

<p><b>Default setting 7: Switch over between fieldbus and jogging using DI 3</b>  <b>All Control Units</b></p> <p>Selected with</p> <ul style="list-style-type: none"> <li>STARTER: Fieldbus with data set switchover</li> <li>BOP-2: FB cdS</li> </ul> <p><b>Factory setting for inverters with PROFIBUS or PROFINET interface</b></p>		<p><b>Default setting 8: Motorized potentiometer (MOP) with safety function</b>  <b>Control Units CU240E-2</b></p> <p>Selected with</p> <ul style="list-style-type: none"> <li>STARTER: MOP with Basic Safety</li> <li>BOP-2: MoP SAFE</li> </ul>																																																																							
<p>PROFIdrive telegram 1</p> <table border="1"> <tr><td>3</td><td>AI 0</td><td>---</td></tr> <tr><td>4</td><td></td><td></td></tr> <tr><td>5</td><td>DI 0</td><td>---</td></tr> <tr><td>6</td><td>DI 1</td><td>---</td></tr> <tr><td>7</td><td>DI 2</td><td>Acknowledge</td></tr> <tr><td>8</td><td>DI 3</td><td>Low</td></tr> <tr><td>16</td><td>DI 4</td><td>---</td></tr> <tr><td>17</td><td>DI 5</td><td>---</td></tr> </table> <p>The CU 240B-2 does not have terminals 16 and 17</p>	3	AI 0	---	4			5	DI 0	---	6	DI 1	---	7	DI 2	Acknowledge	8	DI 3	Low	16	DI 4	---	17	DI 5	---	<p>Fieldbus interface is not active.</p> <table border="1"> <tr><td>3</td><td>AI 0</td><td>---</td></tr> <tr><td>4</td><td></td><td></td></tr> <tr><td>5</td><td>DI 0</td><td>Jog 1</td></tr> <tr><td>6</td><td>DI 1</td><td>Jog 2</td></tr> <tr><td>7</td><td>DI 2</td><td>Acknowledge</td></tr> <tr><td>8</td><td>DI 3</td><td>High</td></tr> <tr><td>16</td><td>DI 4</td><td>---</td></tr> <tr><td>17</td><td>DI 5</td><td>---</td></tr> </table> <p>The CU 240B-2 does not have terminals 16 and 17</p>	3	AI 0	---	4			5	DI 0	Jog 1	6	DI 1	Jog 2	7	DI 2	Acknowledge	8	DI 3	High	16	DI 4	---	17	DI 5	---	<p>Fieldbus interface is not active.</p> <table border="1"> <tr><td>3</td><td>AI 0</td><td>---</td></tr> <tr><td>4</td><td></td><td></td></tr> <tr><td>5</td><td>DI 0</td><td>ON / OFF1</td></tr> <tr><td>6</td><td>DI 1</td><td>MOP raise</td></tr> <tr><td>7</td><td>DI 2</td><td>MOP lower</td></tr> <tr><td>8</td><td>DI 3</td><td>Acknowledge</td></tr> <tr><td>16</td><td>DI 4</td><td rowspan="2">Reserved for safety function</td></tr> <tr><td>17</td><td>DI 5</td></tr> </table>	3	AI 0	---	4			5	DI 0	ON / OFF1	6	DI 1	MOP raise	7	DI 2	MOP lower	8	DI 3	Acknowledge	16	DI 4	Reserved for safety function	17	DI 5
3	AI 0	---																																																																							
4																																																																									
5	DI 0	---																																																																							
6	DI 1	---																																																																							
7	DI 2	Acknowledge																																																																							
8	DI 3	Low																																																																							
16	DI 4	---																																																																							
17	DI 5	---																																																																							
3	AI 0	---																																																																							
4																																																																									
5	DI 0	Jog 1																																																																							
6	DI 1	Jog 2																																																																							
7	DI 2	Acknowledge																																																																							
8	DI 3	High																																																																							
16	DI 4	---																																																																							
17	DI 5	---																																																																							
3	AI 0	---																																																																							
4																																																																									
5	DI 0	ON / OFF1																																																																							
6	DI 1	MOP raise																																																																							
7	DI 2	MOP lower																																																																							
8	DI 3	Acknowledge																																																																							
16	DI 4	Reserved for safety function																																																																							
17	DI 5																																																																								
<p><b>Default setting 9: Motorized potentiometer (MOP)</b>  <b>All Control Units</b></p> <p>Selected with</p> <ul style="list-style-type: none"> <li>STARTER: standard I/O with MOP</li> <li>BOP-2: Std MoP</li> </ul>	<p><b>Default setting 12: Two-wire control with method 1</b>  <b>All Control Units</b></p> <p>Selected with</p> <ul style="list-style-type: none"> <li>STARTER: Standard I/O with analog setpoint</li> <li>BOP-2: Std ASP</li> </ul> <p><b>Factory setting for inverters with RS485 interface</b></p>	<p><b>Default setting 13: Setpoint via analog input with safety function</b>  <b>Control Units CU240E-2</b></p> <p>Selected with</p> <ul style="list-style-type: none"> <li>STARTER: Standard I/O with analog setpoint and safety</li> <li>BOP-2: ASPS</li> </ul>																																																																							
<p>Fieldbus interface is not active.</p> <table border="1"> <tr><td>3</td><td>AI 0</td><td>---</td></tr> <tr><td>4</td><td></td><td></td></tr> <tr><td>5</td><td>DI 0</td><td>ON / OFF1</td></tr> <tr><td>6</td><td>DI 1</td><td>MOP raise</td></tr> <tr><td>7</td><td>DI 2</td><td>MOP lower</td></tr> <tr><td>8</td><td>DI 3</td><td>Acknowledge</td></tr> <tr><td>16</td><td>DI 4</td><td>---</td></tr> <tr><td>17</td><td>DI 5</td><td>---</td></tr> </table> <p>The CU 240B-2 does not have terminals 16 and 17</p>	3	AI 0	---	4			5	DI 0	ON / OFF1	6	DI 1	MOP raise	7	DI 2	MOP lower	8	DI 3	Acknowledge	16	DI 4	---	17	DI 5	---	<p>Fieldbus interface is not active.</p> <table border="1"> <tr><td>3</td><td>AI 0</td><td>Setpoint</td></tr> <tr><td>4</td><td></td><td>  □ ■ U -10 V ... 10 V</td></tr> <tr><td>5</td><td>DI 0</td><td>ON / OFF1</td></tr> <tr><td>6</td><td>DI 1</td><td>Reversing</td></tr> <tr><td>7</td><td>DI 2</td><td>Acknowledge</td></tr> <tr><td>8</td><td>DI 3</td><td>---</td></tr> <tr><td>16</td><td>DI 4</td><td>---</td></tr> <tr><td>17</td><td>DI 5</td><td>---</td></tr> </table> <p>The CU 240B-2 does not have terminals 16 and 17</p>	3	AI 0	Setpoint	4		□ ■ U -10 V ... 10 V	5	DI 0	ON / OFF1	6	DI 1	Reversing	7	DI 2	Acknowledge	8	DI 3	---	16	DI 4	---	17	DI 5	---	<p>Fieldbus interface is not active.</p> <table border="1"> <tr><td>3</td><td>AI 0</td><td>Setpoint</td></tr> <tr><td>4</td><td></td><td>  □ ■ U -10 V ... 10 V</td></tr> <tr><td>5</td><td>DI 0</td><td>ON / OFF1</td></tr> <tr><td>6</td><td>DI 1</td><td>Reversing</td></tr> <tr><td>7</td><td>DI 2</td><td>Acknowledge</td></tr> <tr><td>8</td><td>DI 3</td><td>---</td></tr> <tr><td>16</td><td>DI 4</td><td rowspan="2">Reserved for safety function</td></tr> <tr><td>17</td><td>DI 5</td></tr> </table>	3	AI 0	Setpoint	4		□ ■ U -10 V ... 10 V	5	DI 0	ON / OFF1	6	DI 1	Reversing	7	DI 2	Acknowledge	8	DI 3	---	16	DI 4	Reserved for safety function	17	DI 5
3	AI 0	---																																																																							
4																																																																									
5	DI 0	ON / OFF1																																																																							
6	DI 1	MOP raise																																																																							
7	DI 2	MOP lower																																																																							
8	DI 3	Acknowledge																																																																							
16	DI 4	---																																																																							
17	DI 5	---																																																																							
3	AI 0	Setpoint																																																																							
4		□ ■ U -10 V ... 10 V																																																																							
5	DI 0	ON / OFF1																																																																							
6	DI 1	Reversing																																																																							
7	DI 2	Acknowledge																																																																							
8	DI 3	---																																																																							
16	DI 4	---																																																																							
17	DI 5	---																																																																							
3	AI 0	Setpoint																																																																							
4		□ ■ U -10 V ... 10 V																																																																							
5	DI 0	ON / OFF1																																																																							
6	DI 1	Reversing																																																																							
7	DI 2	Acknowledge																																																																							
8	DI 3	---																																																																							
16	DI 4	Reserved for safety function																																																																							
17	DI 5																																																																								

<p><b>Default setting 14: Switch over between fieldbus and motorized potentiometer (MOP) using DI 3</b></p> <p style="text-align: center;"><b>Control Units CU230P-2 and CU240E-2</b></p> <p>Selected with</p> <ul style="list-style-type: none"> <li>• STARTER: Process industry with fieldbus</li> <li>• BOP-2: Proc Fb</li> </ul>																																																		
<p>PROFIdrive telegram 20</p> <table border="1"> <tr><td>3</td><td>AI 0</td><td>---</td></tr> <tr><td>4</td><td></td><td></td></tr> <tr><td>5</td><td>DI 0</td><td>---</td></tr> <tr><td>6</td><td>DI 1</td><td>External fault</td></tr> <tr><td>7</td><td>DI 2</td><td>Acknowledge</td></tr> <tr><td>8</td><td>DI 3</td><td>Low</td></tr> <tr><td>16</td><td>DI 4</td><td>---</td></tr> <tr><td>17</td><td>DI 5</td><td>---</td></tr> </table>	3	AI 0	---	4			5	DI 0	---	6	DI 1	External fault	7	DI 2	Acknowledge	8	DI 3	Low	16	DI 4	---	17	DI 5	---	<p>Fieldbus interface is not active.</p> <table border="1"> <tr><td>3</td><td>AI 0</td><td>---</td></tr> <tr><td>4</td><td></td><td></td></tr> <tr><td>5</td><td>DI 0</td><td>ON / OFF1</td></tr> <tr><td>6</td><td>DI 1</td><td>External fault</td></tr> <tr><td>7</td><td>DI 2</td><td>Acknowledge</td></tr> <tr><td>8</td><td>DI 3</td><td>High</td></tr> <tr><td>16</td><td>DI 4</td><td>MOP raise</td></tr> <tr><td>17</td><td>DI 5</td><td>MOP lower</td></tr> </table>	3	AI 0	---	4			5	DI 0	ON / OFF1	6	DI 1	External fault	7	DI 2	Acknowledge	8	DI 3	High	16	DI 4	MOP raise	17	DI 5	MOP lower	
3	AI 0	---																																																
4																																																		
5	DI 0	---																																																
6	DI 1	External fault																																																
7	DI 2	Acknowledge																																																
8	DI 3	Low																																																
16	DI 4	---																																																
17	DI 5	---																																																
3	AI 0	---																																																
4																																																		
5	DI 0	ON / OFF1																																																
6	DI 1	External fault																																																
7	DI 2	Acknowledge																																																
8	DI 3	High																																																
16	DI 4	MOP raise																																																
17	DI 5	MOP lower																																																
<p><b>Default setting 15: Switch over between analog setpoint and motorized potentiometer (MOP) using DI 3</b></p> <p style="text-align: center;"><b>Control Units CU230P-2 and CU240E-2</b></p> <p>Selected with</p> <ul style="list-style-type: none"> <li>• STARTER: Process industry</li> <li>• BOP-2: Proc</li> </ul>																																																		
<p>Fieldbus interface is not active.</p> <table border="1"> <tr><td>3</td><td>AI 0</td><td>Setpoint</td></tr> <tr><td>4</td><td></td><td>I <input type="checkbox"/> U -10 V ... 10 V</td></tr> <tr><td>5</td><td>DI 0</td><td>ON / OFF1</td></tr> <tr><td>6</td><td>DI 1</td><td>External fault</td></tr> <tr><td>7</td><td>DI 2</td><td>Acknowledge</td></tr> <tr><td>8</td><td>DI 3</td><td>Low</td></tr> <tr><td>16</td><td>DI 4</td><td>---</td></tr> <tr><td>17</td><td>DI 5</td><td>---</td></tr> </table>	3	AI 0	Setpoint	4		I <input type="checkbox"/> U -10 V ... 10 V	5	DI 0	ON / OFF1	6	DI 1	External fault	7	DI 2	Acknowledge	8	DI 3	Low	16	DI 4	---	17	DI 5	---	<p>Fieldbus interface is not active.</p> <table border="1"> <tr><td>3</td><td>AI 0</td><td>---</td></tr> <tr><td>4</td><td></td><td></td></tr> <tr><td>5</td><td>DI 0</td><td>ON / OFF1</td></tr> <tr><td>6</td><td>DI 1</td><td>External fault</td></tr> <tr><td>7</td><td>DI 2</td><td>Acknowledge</td></tr> <tr><td>8</td><td>DI 3</td><td>High</td></tr> <tr><td>16</td><td>DI 4</td><td>MOP raise</td></tr> <tr><td>17</td><td>DI 5</td><td>MOP lower</td></tr> </table>	3	AI 0	---	4			5	DI 0	ON / OFF1	6	DI 1	External fault	7	DI 2	Acknowledge	8	DI 3	High	16	DI 4	MOP raise	17	DI 5	MOP lower	
3	AI 0	Setpoint																																																
4		I <input type="checkbox"/> U -10 V ... 10 V																																																
5	DI 0	ON / OFF1																																																
6	DI 1	External fault																																																
7	DI 2	Acknowledge																																																
8	DI 3	Low																																																
16	DI 4	---																																																
17	DI 5	---																																																
3	AI 0	---																																																
4																																																		
5	DI 0	ON / OFF1																																																
6	DI 1	External fault																																																
7	DI 2	Acknowledge																																																
8	DI 3	High																																																
16	DI 4	MOP raise																																																
17	DI 5	MOP lower																																																



<p><b>Default setting 17: Two-wire control with method 2</b></p> <p style="text-align: center;"><b>All Control Units</b></p> <p>Selected with</p> <ul style="list-style-type: none"> <li>STARTER: 2-wire (forward/backward 1)</li> <li>BOP-2: 2-wlrE 1</li> </ul>	<p><b>Default setting 18: Two-wire control with method 3</b></p> <p style="text-align: center;"><b>All Control Units</b></p> <p>Selected with</p> <ul style="list-style-type: none"> <li>STARTER: 2-wire (forward/backward 2)</li> <li>BOP-2: 2-wlrE 2</li> </ul>	<p><b>Default setting 19: Three-wire control with method 1</b></p> <p style="text-align: center;"><b>All Control Units</b></p> <p>Selected with</p> <ul style="list-style-type: none"> <li>STARTER: 3-wire (enable/forward/backward)</li> <li>BOP-2: 3-wlrE 1</li> </ul>																																																																								
<p style="text-align: center;">Fieldbus interface is not active.</p> <table border="1" style="margin-left: auto; margin-right: auto;"> <tr><td>3</td><td>AI 0</td><td>Setpoint</td></tr> <tr><td>4</td><td></td><td>I □ U -10 V ... 10 V</td></tr> <tr><td>5</td><td>DI 0</td><td>ON/OFF1 clockwise</td></tr> <tr><td>6</td><td>DI 1</td><td>ON / OFF1 counter-clockwise</td></tr> <tr><td>7</td><td>DI 2</td><td>Acknowledge</td></tr> <tr><td>8</td><td>DI 3</td><td>---</td></tr> <tr><td>16</td><td>DI 4</td><td>---</td></tr> <tr><td>17</td><td>DI 5</td><td>---</td></tr> </table> <p style="text-align: center;">The CU 240B-2 does not have terminals 16 and 17</p>		3	AI 0	Setpoint	4		I □ U -10 V ... 10 V	5	DI 0	ON/OFF1 clockwise	6	DI 1	ON / OFF1 counter-clockwise	7	DI 2	Acknowledge	8	DI 3	---	16	DI 4	---	17	DI 5	---	<p style="text-align: center;">Fieldbus interface is not active.</p> <table border="1" style="margin-left: auto; margin-right: auto;"> <tr><td>3</td><td>AI 0</td><td>Setpoint</td></tr> <tr><td>4</td><td></td><td>I □ U -10 V ... 10 V</td></tr> <tr><td>5</td><td>DI 0</td><td>Enable / OFF1</td></tr> <tr><td>6</td><td>DI 1</td><td>ON clockwise</td></tr> <tr><td>7</td><td>DI 2</td><td>ON counter-clockwise</td></tr> <tr><td>8</td><td>DI 3</td><td>---</td></tr> <tr><td>16</td><td>DI 4</td><td>Acknowledge</td></tr> <tr><td>17</td><td>DI 5</td><td>---</td></tr> </table> <p style="text-align: center;">The CU 240B-2 does not have terminals 16 and 17</p>	3	AI 0	Setpoint	4		I □ U -10 V ... 10 V	5	DI 0	Enable / OFF1	6	DI 1	ON clockwise	7	DI 2	ON counter-clockwise	8	DI 3	---	16	DI 4	Acknowledge	17	DI 5	---																								
3	AI 0	Setpoint																																																																								
4		I □ U -10 V ... 10 V																																																																								
5	DI 0	ON/OFF1 clockwise																																																																								
6	DI 1	ON / OFF1 counter-clockwise																																																																								
7	DI 2	Acknowledge																																																																								
8	DI 3	---																																																																								
16	DI 4	---																																																																								
17	DI 5	---																																																																								
3	AI 0	Setpoint																																																																								
4		I □ U -10 V ... 10 V																																																																								
5	DI 0	Enable / OFF1																																																																								
6	DI 1	ON clockwise																																																																								
7	DI 2	ON counter-clockwise																																																																								
8	DI 3	---																																																																								
16	DI 4	Acknowledge																																																																								
17	DI 5	---																																																																								
<p><b>Default setting 20: Three-wire control with method 2</b></p> <p style="text-align: center;"><b>All Control Units</b></p> <p>Selected with</p> <ul style="list-style-type: none"> <li>STARTER: 3-wire (enable/on/reverse)</li> <li>BOP-2: 3-wlrE 2</li> </ul>	<p><b>Default setting 21: Fieldbus USS</b></p> <p style="text-align: center;"><b>All Control Units</b></p> <p>Selected with</p> <ul style="list-style-type: none"> <li>STARTER: USS fieldbus</li> <li>BOP-2: FB USS</li> </ul>	<p><b>Default setting 22: Fieldbus CANopen</b></p> <p style="text-align: center;"><b>Control Units CU230P-2</b></p> <p>Selected with</p> <ul style="list-style-type: none"> <li>STARTER: CAN fieldbus</li> <li>BOP-2: FB CAN</li> </ul>																																																																								
<p style="text-align: center;">Fieldbus interface is not active.</p> <table border="1" style="margin-left: auto; margin-right: auto;"> <tr><td>3</td><td>AI 0</td><td>Setpoint</td></tr> <tr><td>4</td><td></td><td>I □ U -10 V ... 10 V</td></tr> <tr><td>5</td><td>DI 0</td><td>Enable / OFF1</td></tr> <tr><td>6</td><td>DI 1</td><td>ON</td></tr> <tr><td>7</td><td>DI 2</td><td>Reversing</td></tr> <tr><td>8</td><td>DI 3</td><td>---</td></tr> <tr><td>16</td><td>DI 4</td><td>Acknowledge</td></tr> <tr><td>17</td><td>DI 5</td><td>---</td></tr> </table> <p style="text-align: center;">The CU 240B-2 does not have terminals 16 and 17</p>	3	AI 0	Setpoint	4		I □ U -10 V ... 10 V	5	DI 0	Enable / OFF1	6	DI 1	ON	7	DI 2	Reversing	8	DI 3	---	16	DI 4	Acknowledge	17	DI 5	---	<p style="text-align: center;">USS setting: 38400 baud, 2 PZD, PKW variable</p> <table border="1" style="margin-left: auto; margin-right: auto;"> <tr><td>3</td><td>AI 0</td><td>---</td></tr> <tr><td>4</td><td></td><td>---</td></tr> <tr><td>5</td><td>DI 0</td><td>---</td></tr> <tr><td>6</td><td>DI 1</td><td>---</td></tr> <tr><td>7</td><td>DI 2</td><td>Acknowledge</td></tr> <tr><td>8</td><td>DI 3</td><td>---</td></tr> <tr><td>16</td><td>DI 4</td><td>---</td></tr> <tr><td>17</td><td>DI 5</td><td>---</td></tr> </table> <p style="text-align: center;">The CU 240B-2 does not have terminals 16 and 17</p>	3	AI 0	---	4		---	5	DI 0	---	6	DI 1	---	7	DI 2	Acknowledge	8	DI 3	---	16	DI 4	---	17	DI 5	---	<p style="text-align: center;">CANopen setting: 20 kBaud</p> <table border="1" style="margin-left: auto; margin-right: auto;"> <tr><td>3</td><td>AI 0</td><td>---</td></tr> <tr><td>4</td><td></td><td>---</td></tr> <tr><td>5</td><td>DI 0</td><td>---</td></tr> <tr><td>6</td><td>DI 1</td><td>---</td></tr> <tr><td>7</td><td>DI 2</td><td>Acknowledge</td></tr> <tr><td>8</td><td>DI 3</td><td>---</td></tr> <tr><td>16</td><td>DI 4</td><td>---</td></tr> <tr><td>17</td><td>DI 5</td><td>---</td></tr> </table>	3	AI 0	---	4		---	5	DI 0	---	6	DI 1	---	7	DI 2	Acknowledge	8	DI 3	---	16	DI 4	---	17	DI 5	---
3	AI 0	Setpoint																																																																								
4		I □ U -10 V ... 10 V																																																																								
5	DI 0	Enable / OFF1																																																																								
6	DI 1	ON																																																																								
7	DI 2	Reversing																																																																								
8	DI 3	---																																																																								
16	DI 4	Acknowledge																																																																								
17	DI 5	---																																																																								
3	AI 0	---																																																																								
4		---																																																																								
5	DI 0	---																																																																								
6	DI 1	---																																																																								
7	DI 2	Acknowledge																																																																								
8	DI 3	---																																																																								
16	DI 4	---																																																																								
17	DI 5	---																																																																								
3	AI 0	---																																																																								
4		---																																																																								
5	DI 0	---																																																																								
6	DI 1	---																																																																								
7	DI 2	Acknowledge																																																																								
8	DI 3	---																																																																								
16	DI 4	---																																																																								
17	DI 5	---																																																																								

The default settings for BT inverters are also described in the operating instructions. See also: Manuals for your inverter (Page 47).

### 3.3.4 Wiring the terminal strip

<p><b>NOTICE</b></p> <p><b>Damage to the inverter when using long signal cables</b></p> <p>Using long cables at the inverter's digital inputs and 24 V power supply can lead to overvoltage during switching operations. Overvoltages can damage the inverter.</p> <ul style="list-style-type: none"> <li>If you use cables of more than 30 m at the digital inputs and 24 V power supply, connect an overvoltage protection element between the terminal and the associated reference potential. We recommend using the Weidmüller overvoltage protection terminal with designation MCZ OVP TAZ DIODE 24VDC.</li> </ul>
--

**Procedure**



Proceed as follows to connect the terminal strips:

1. Use a cable with the recommended cross-section, which has been appropriately prepared for use:

Solid or flexible cable	9 mm 0.5 ... 1.5 mm <sup>2</sup>
Flexible conductor with non-insulated end sleeve	9 mm 0.5 mm <sup>2</sup>
Flexible conductor with partially-insulated end sleeve	9 mm 0.5 mm <sup>2</sup>
Only permitted for CU240B/E-2: Two flexible cables with the same cross-section with partially insulated twin end sleeves	9 mm 0.5 mm <sup>2</sup>

2. If you use shielded cables, then you must connect the shield to the mounting plate of the control cabinet or with the shield support of the inverter through a good electrical connection and a large surface area.  
See also: EMC installation guideline (<http://support.automation.siemens.com/WW/view/en/60612658>)
3. Use the shield connection plate of the Control Unit as strain relief, also see: Overview of the shield connection kits (<http://support.automation.siemens.com/WW/news/en/67225884>).



You have connected the terminal strip.



### 3.4 Connecting up the fieldbus

#### Interfaces at the lower side of the CU230P-2 Control Unit

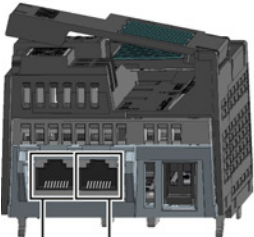
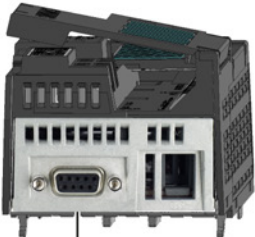
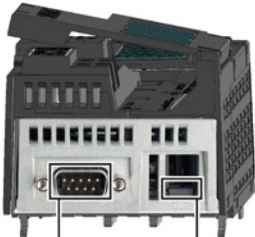
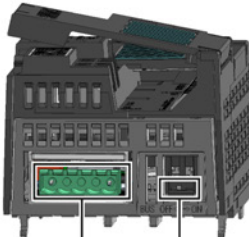
CU230P-2 PN	CU230P-2 DP	CU230P-2 CAN	CU230P-2 HVAC
 <p>X150 P1    X150 P2</p>	 <p>X127 Buchse</p>	 <p>X126 Stecker    OFF ON Busabschluss</p>	 <p>X128 OFF ON Busabschluss</p>
<p>Pin</p> <ul style="list-style-type: none"> <li>1 RX+, receive data +</li> <li>2 RX-, receive data -</li> <li>3 TX+, Transmit data +</li> <li>4 ---</li> <li>5 ---</li> <li>6 TX-, transmit data -</li> <li>7 ---</li> <li>8 ---</li> </ul>	<p>Pin</p> <ul style="list-style-type: none"> <li>1 Shield, ground connection</li> <li>2 ---</li> <li>3 RxD/TxD-P, receive and transmit (B/B')</li> <li>4 CNTR-P, control signal</li> <li>5 DGND, reference potential for data (C/C')</li> <li>6 VP, supply voltage</li> <li>7 ---</li> <li>8 RxD/TxD-N, receive and transmit (A/A')</li> <li>9 ---</li> </ul>	<p>Pin</p> <ul style="list-style-type: none"> <li>1 ---</li> <li>2 CAN_L, CAN signal (dominant low)</li> <li>3 CAN_GND, CAN ground</li> <li>4 ---</li> <li>5 (CAN_SHLD), optional shield</li> <li>6 (GND), optional ground</li> <li>7 CAN_H, CAN signal (dominant high)</li> <li>8 ---</li> <li>9 ---</li> </ul>	<p>Pin</p> <ul style="list-style-type: none"> <li>1 0 V, reference potential</li> <li>2 RS485P, receive and transmit (+)</li> <li>3 RS485N, receive and transmit (-)</li> <li>4 Cable shield</li> <li>5 ---</li> </ul>

#### Interfaces at the lower side of the CU240B-2 and CU240E-2 Control Units

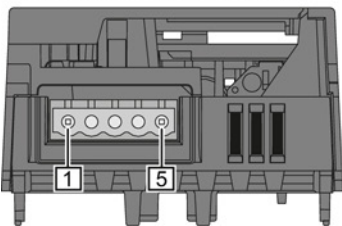
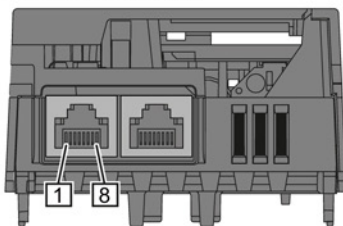
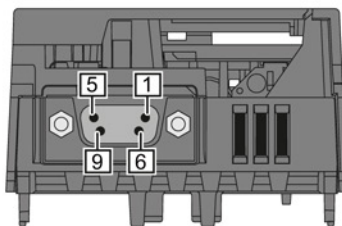
RS485 plug for USS and Modbus RTU (X128)	RJ45 connector socket for PROFINET IO (X150 P1, X150 P2)	SUB-D socket for PROFIBUS DP (X126)
 <p>1    5</p>	 <p>1    8</p>	 <p>5    1 9    6</p>
<p>Pin</p> <ul style="list-style-type: none"> <li>1 0 V, reference potential</li> <li>2 RS485P, receive and transmit (+)</li> <li>3 RS485N, receive and transmit (-)</li> <li>4 Cable shield</li> <li>5 Not connected</li> </ul>	<p>Pin</p> <ul style="list-style-type: none"> <li>1 RX+, receive data +</li> <li>2 RX-, receive data -</li> <li>3 TX+, Transmit data +</li> <li>4 Not assigned</li> <li>5 Not assigned</li> <li>6 TX-, transmit data -</li> <li>7 Not assigned</li> <li>8 Not assigned</li> </ul>	<p>Pin</p> <ul style="list-style-type: none"> <li>1 Shield, grounding connection</li> <li>2 Not assigned</li> <li>3 RxD/TxD-P, receive and transmit (B/B')</li> <li>4 CNTR-P, control signal</li> <li>5 DGND, reference potential for data (C/C')</li> <li>6 VP, supply voltage</li> <li>7 Not assigned</li> <li>8 RxD/TxD-N, receive and transmit (A/A')</li> <li>9 Not assigned</li> </ul>

### Description files for fieldbuses





The description files contain the information required to configure and operate the inverter on a fieldbus under a higher-level control.

Description file	Download	Alternative to download
GSD for PROFIBUS	Internet: ( <a href="http://support.automation.siemens.com/WW/view/en/23450835">http://support.automation.siemens.com/WW/view/en/23450835</a> )	GSD and GSDML are saved in the inverter. The inverter writes its GSD or GSDML to the memory card once you insert this card in the inverter and set p0804 to 12. You can then transfer the file to your programming device or PC using the memory card.
GSDML for PROFINET	Internet: ( <a href="http://support.automation.siemens.com/WW/view/en/26641490">http://support.automation.siemens.com/WW/view/en/26641490</a> )	
EDS for CANopen	Internet: ( <a href="http://support.automation.siemens.com/WW/view/en/48351511">http://support.automation.siemens.com/WW/view/en/48351511</a> )	---
EDS for Ethernet/IP	---	Further information can be found in the operating instructions

## Commissioning

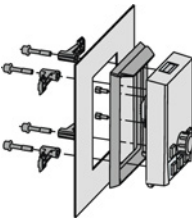
### 4.1 Tools to commission the converter

The following tools are used to commission, troubleshoot and control the inverter, as well as to backup and transfer the inverter settings.

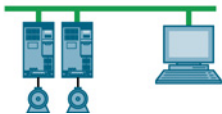
Operator panels			Order number
	<p>BOP-2 (Basic Operator Panel) - for snapping onto the inverter</p> <ul style="list-style-type: none"> <li>Two-line display</li> <li>Guided basic commissioning</li> </ul>		<p>Door mounting kit for IOP/BOP-2</p> <ul style="list-style-type: none"> <li>For installation of the BOP-2 or IOP in a control cabinet door.</li> <li>Degree of protection with IOP: IP54 or UL Type 12</li> <li>Degree of protection with BOP-2: IP55</li> </ul>
	<p>IOP (Intelligent Operator Panel) - for snapping onto the inverter</p> <ul style="list-style-type: none"> <li>Plain text display</li> <li>Menu-based operation and application wizards</li> </ul>		<p>BOP-2: 6SL3255-0AA00-4CA1</p> <p>IOP: 6SL3255-0AA00-4JA0</p> <p>Door mounting kit: 6SL3256-0AP00-0JA0</p>
	<p>For mobile use of the IOP: IOP handheld with power supply unit and rechargeable batteries as well as RS232 connection cable</p> <p>If you are using your own connection cable, carefully note the maximum permissible length of 5 m.</p>	<p>6SL3255-0AA00-4HA0</p>	
PC tools			
	<p>STARTER Connected to the inverter via USB port, PROFIBUS or PROFINET</p> <p>Download: STARTER <a href="http://support.automation.siemens.com/WW/view/en/10804985/130000">http://support.automation.siemens.com/WW/view/en/10804985/130000</a></p>	<p>STARTER on DVD: 6SL3072-0AA00-0AG0</p>	
	<p>Startdrive Connected to the inverter via USB port, PROFIBUS or PROFINET</p> <p>Download: Startdrive <a href="http://support.automation.siemens.com/WW/view/en/68034568">http://support.automation.siemens.com/WW/view/en/68034568</a></p>	<p>Startdrive on DVD: 6SL3072-4CA02-1XG0</p>	
	<p>SINAMICS PC Inverter Connection Kit 2 Contains the correct USB cable (3 m) to connect a PC to the inverter.</p>	<p>6SL3255-0AA00-2CA0</p>	

## 4.2 IOP Intelligent Operator Panel

The IOP is an operator device with which you can commission the frequency converter locally, enter parameters and monitor operation.







The display is subdivided into various areas

- Status and diagnostics display
- Status message
- Selection menu

- ① Status and diagnostics display
- ② Status message, here: Output voltage
- ③ Status message here: Output frequency
- ④ Selection menu: Wizard / Control / Menu



### Handling the IOP

	<ul style="list-style-type: none"> <li>• You can select a menu by turning the navigation wheel, e.g. WIZARD</li> <li>• You confirm your selection by pressing on the navigation wheel (OK).</li> </ul>
	<p>By pressing, you can toggle between external command sources and the IOP as command source.</p> <ul style="list-style-type: none"> <li>• MANUAL means: Manual control using the IOP buttons</li> <li>• AUTO means: The frequency converter responds to the external control commands (e.g. fieldbus or terminals)</li> </ul>
	<ul style="list-style-type: none"> <li>• In the AUTO mode: without function</li> <li>• In the MANUAL mode: Pressing starts the frequency converter</li> </ul>
	<ul style="list-style-type: none"> <li>• In the AUTO mode: without function</li> <li>• In the MANUAL mode:                         <ul style="list-style-type: none"> <li>– Press briefly: OFF1 - the motor comes to a standstill along the selected down ramp (P1121)</li> <li>– Pressing longer than 3 seconds: OFF2 - the motor coasts down to standstill</li> </ul> </li> </ul>
	<ul style="list-style-type: none"> <li>• Pressing supplies information about the actual display</li> <li>• You return to the display by pressing again</li> </ul>
	<ul style="list-style-type: none"> <li>• Press briefly: Return to the previous display</li> <li>• Pressing longer than 3 seconds: The IOP returns to the status screen</li> </ul>

## Menu structure

The menu depicted here shows the basic structure. There are different sub-structures, depending on the software version and the Control Unit.

Instead of using the application Wizards, you can also use individual parameters to directly change all of the settings.

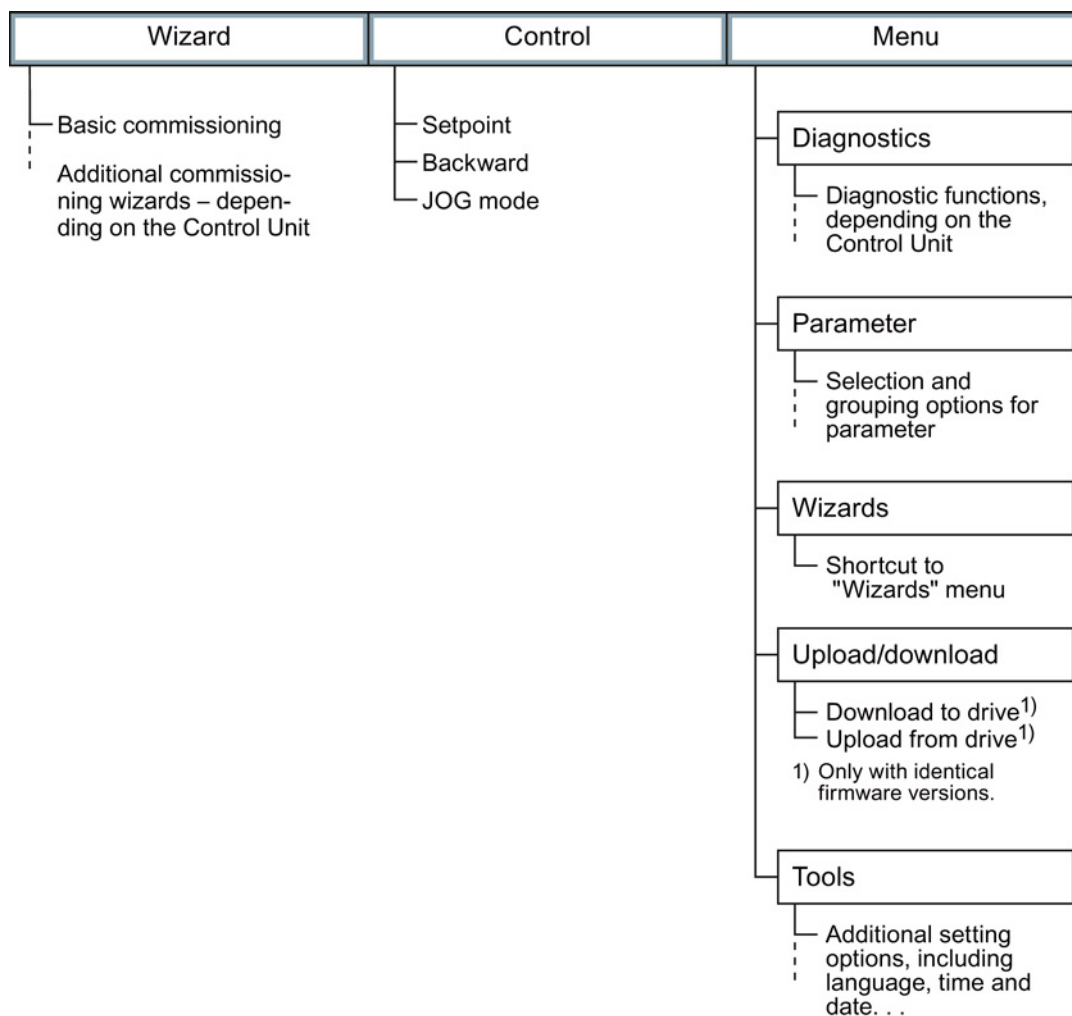

### 4.3 Commissioning

Commissioning is carried out with the IOP using one of the "basic commissioning wizards (Page 36)". If the IOP does not contain the actual frequency converter software, a message is displayed "Update is required". You can find the required information on the Internet at "<http://support.automation.siemens.com/WW/view/de/67273266>" (<http://support.automation.siemens.com/WW/view/en/67273266>)".

In the basic commissioning, select the control mode for the motor, enter the motor data and define the pre-assignment of the frequency converter interfaces. You can find the corresponding wiring in section "Default settings of the terminal strip (Page 28)".

<b>SIEMENS</b> (H) (EFF I)						
D-91056 Erlangen						
3-Mot. 1LE10011AC434AA0				E0807/0496382		
IEC/EN 60034 100L		IMB3		IP55		
25 kg	Th.Cl. 155(F)	-20°C Tamb 40°C				
	Bearing	UNIREX-N3				
DE	6206-2ZC3	15g	Intervall: 4000hrs			
NE	6206-2ZC3	11g				
60Hz:	SF 1.15 CONT NEMA MG1-12					
V	Hz	A	kW	PF	NOM.EFF	rpm
400 Δ	50	3.5	1.5	0.73	84.5%	970
690 Y	50	2.05	1.5	0.73	84.5%	970
460 Δ	60	3.15	1.5	0.69	86.5%	1175
(2)	(1)	(3)	(4)	(5)		

- ① Motor frequency (P0310)
- ② Motor voltage (p0304)
- ③ Motor current (P0305)
- ④ Motor power (P0307)
- ⑤ Rated motor speed (P0311)

#### Overview of the commissioning

- When commissioning with wizards, the first step is to RESET to the factory settings. This ensures that the frequency converter is in a defined basic setting.  
After the basic commissioning, the wizard that you selected guides you through the application-specific settings.
- Before the frequency converter accepts your commissioning data, you must check these and confirm them. You do this using the last but one menu item OVERVIEW OF THE SETTINGS. In this screen, scroll down to CONTINUE and acknowledge it with OK.
- The last step is the prompt SAVE or INTERRUPT WIZARD? Select SAVE! Commissioning using the wizards has now been completed.
- You can subsequently change your converter settings (Section "The most important parameters at a glance (Page 42)").
- Once you have completed commissioning, you should back up the settings of your frequency converter e.g. on the IOP, so that they are not lost if the frequency converter develops a defect.

## 4.3.1 Settings in the basic commissioning menu

### Basic commissioning

The "Basic commissioning" wizard sets the most important data for commissioning the drive. The number of commissioning steps depends on the particular Control Unit.

#### Procedure

Proceed as follows to carry out basic commissioning of the inverter:

1. Start the menu: WIZARD / BASIC COMMISSIONING, and set the following:



	Screen form	Setting	Param.
2.	Restore factory settings	[1] yes	p0970
3.	Control mode	[0] V/f with linear characteristic	p1300
4.	Motor data	[0] Europe 50 Hz, kW	p0100
5.	Motor type	[1] Induction motor	p0300
6.	Motor code	The motor data is pre-assigned using the motor code.	p0301
7.	Characteristic	50 Hz / 87 Hz	---
8.	Motor connections	Observe the motor connection (star / delta)!	OK
9.	Motor data	Enter the motor data for 50 Hz	OK
10.	Motor voltage	Enter [V] according to the motor rating plate	p0304
11.	Motor current	Enter [A] according to the motor rating plate	p0305
12.	Rated power	Enter [kW] (or [hp]) according to the motor rating plate	p0307
13.	cos φ		p0308
14.	Motor speed	Enter [rpm] according to the motor rating plate	p0311
15.	Current limit	[A] maximum 4* p0305	p0640
16.	Motor data ID	[1] Stationary and rotating measurement <sup>1)</sup> If the motor cannot freely rotate, e.g. if travel is mechanically limited, select the setting [2] "MotID only stationary".	p1900
17.	Encoder type	[0] Not activated	p0400
18.	Encoder pulses	Encoder type not activated	OK
19.	Macro device	Select a pre-defined setting, see Section: Default settings of the terminal strip (Page 28)	p0015
20.	Minimum speed	Enter the minimum speed [rpm], above which the motor should operate.	p1080
21.	Ramp-up	Time [s] in which the motor should be accelerated from standstill up to the maximum speed (p1082).	p1120
22.	Ramp-down	Time [s] in which the motor should be decelerated from the maximum speed (p1082) down to standstill.	p1121
23.	Motor temperature sensor	Enter type of temperature sensor	p0610
24.	Motor holding brake	Enter configuration	p1215
25.	MHB opening time	Set opening time	p1216
26.	MHB closing time	Set closing time	p1217

	Screen form	Setting	Param.
27.	Overview of the settings	Check list + select < Continue >	OK
28.	Save settings	Save	OK
29.	Saving, please wait		OK

1) If the IOP Assistant does not offer this setting, after completing the basic commissioning, set parameter p1900 to a value of 1 using the parameter menu.



You have completed the inverter's basic commissioning.

### Identifying the motor data and optimizing the closed-loop control

Following basic commissioning, the inverter generally has to measure other motor data and optimize its current and speed controllers.

To start motor data identification, you must switch on the motor.

 <b>WARNING</b>
<p><b>Risk of fatal injury as a result of machine movements when switching on the motor</b></p> <p>Switching on the motor for identification purposes may result in hazardous machine movements.</p> <p>Secure dangerous machine parts before starting motor data identification:</p> <ul style="list-style-type: none"> <li>• Before switching on, check that no parts are loose on the machine or can be spun out.</li> <li>• Before switching on, ensure that nobody is working on the machine or located within its working area.</li> <li>• Secure the machine's work area against unintended access.</li> <li>• Lower hanging/suspended loads to the floor.</li> </ul>

#### Preconditions

- In the basic commissioning, you have selected the motor data ID. In this case, after the basic commissioning has been completed, the inverter issues the alarm A07991.
- The motor has cooled down to the ambient temperature.

If the motor is too hot, the motor data identification will provide incorrect values and the closed-loop speed control can become unstable.





### Procedure

To identify the motor data, proceed as follows:

1. Switch on the motor. You can enter the on command via the terminal strip, fieldbus, or operator panel.
2. Wait until the inverter switches off the motor after completion of the motor data identification. The measurement takes several seconds.
3. Backup the results of the motor data identification in the inverter so that they are not lost when the power fails: TOOLS - PARAMETER SETTINGS - SAVE RAM TO ROM

If you have also selected a rotating measurement in addition to the motor data identification, then the inverter again issues the alarm A07991.

1. Switch the motor on again in order to optimize the speed control.
2. Wait until the inverter switches off the motor after completion of the optimization. The optimization can take up to one minute.
3. Backup the results of the motor data identification in the inverter so that they are not lost when the power fails: TOOLS - PARAMETER SETTINGS - SAVE RAM TO ROM



You have now identified the motor data and the closed-loop speed control has been optimized.

## 4.3.2 Enable "Safe Torque Off" safety function

### Requirements:

- Commission a CU240E-2 Control Unit.
- In the basic commissioning, you selected a setting for the interfaces in which two terminals are reserved for a safety function.

The "Basic Safety" wizard guides you through the enabling of the "Safe Torque Off" safety function. Depending on the interface for "Safe Torque Off", the inverter skips individual steps.

---

### Note

If you enable "Safe Torque Off" via digital inputs, then the inverter interconnects digital inputs DI 4 and DI 5 to the fail-safe digital input F-DI. The drive can respond unexpectedly if you additionally interconnect these same inputs with other functions.

- Use digital inputs DI 4 and DI 5 exclusively for "Safe Torque Off".
-

**Procedure**



To enable the "Safe Torque Off" safety function, proceed as follows:

1. Select: "Basic Safety" commissioning

2.	Enter the password for fail-safe function (factory setting = 0)	Confirm with OK
3.	When "Password correct" is displayed, acknowledge with "Continue". If you have entered the wrong password, you can return with the button "ESC" and re-enter the password or cancel the commissioning.	OK
4.	Change the Safety password? Yes/No	OK
5.	If yes, then enter a new password (0 ... FFFF FFFF)	OK
6.	Reset "Basic Safety" to factory setting? Yes/No	OK
7.	STO via terminal? Yes/No	OK
8.	If yes: The inverter interconnects DI 4 and DI 5 with a fail-safe input F_DI.	
9.	Set the debounce time for the F-DI	OK
10.	Set the switchover tolerance for the F-DI.	OK
11.	STO via PROFIsafe? Yes/No	OK
12.	If yes, then enter the PROFIsafe address.	OK
13.	Select the PROFIsafe telegram.	OK
14.	Set the monitoring time for the forced dormant error detection. You have to select an STO after the end of the monitoring time at the latest to ensure that the inverter checks its safety-related circuits.	OK
15.	Overview of the settings Check the list + select < Continue >	OK
16.	Save the settings	OK
17.	Wait until the inverter has saved the data.	



You have enabled the STO safety function in the inverter.

### 4.3.3 The most important parameters at a glance

Table 4- 1 Defining the interfaces of the frequency converter

Parameter	Possible settings
p0015	<b>Macro drive unit</b> Define the pre-assignment for the inputs and outputs using one of the macros 1 to 22 Default settings of the terminal strip (Page 28).

Table 4- 2 Set fixed speeds

Parameter	Description
p1001	Fixed speed 1
p1002	Fixed speed 2
p1003	Fixed speed 3
p1004	Fixed speed 4

Table 4- 3 Set jogging

Parameter	Description
p1058	Jog 1
p1059	Jog 2

Table 4- 4 Selecting the fieldbus protocol

Parameter	Possible settings (selection options, depend on the CU type)
p2030	0: No protocol (this means: Control via digital inputs/connecting terminals) 1: USS 2: Modbus 3: PROFIBUS DP 4: CAN 5: BACnet 7: PROFINET 8: P1

Table 4- 5 Set the USS interface

Parameter	Description
p2020	<b>Set the baud rate</b>
	Value    Baud rate
	4    2400
	5    4800
	6    9600
	7    19200
p2022	<b>Fieldbus interface USS PZD number</b> Sets the number of 16-bit words in the PZD part of the USS telegram Setting range: 0... 8 (0 ... 8 words)
	Value    Baud rate
	8    38400
	9    57600
	10    76800
	11    93750
p2023	<b>Fieldbus interface USS PKW number</b> Sets the number of 16-bit words in the PKW part of the USS telegram Setting range:
	<ul style="list-style-type: none"> <li>• 0, 3, 4: 0, 3 or 4 words</li> <li>• 127: variable length</li> </ul>

Table 4- 6 Setting the ramp-function generator

Parameter	Description
p1080	Minimum speed in [rpm]
p1082	Maximum speed in [rpm]
p1120	Ramp-up time of the motor after switching on in [s]
p1121	Ramp-down time of the motor after switching off in [s]

4.3 Commissioning

Table 4- 7 Setting the control mode

Parameter	Possible settings
p1300	<b>Setting the open-loop and closed-loop control mode of a drive</b> 0: V/f control with linear characteristic 1: Linear V/f characteristic with Flux Current Control (FCC) 2: V/f control with square-law characteristic 3: Freely selectable V/f characteristic 4: Linear V/f characteristic ECO 5: Linear V/f characteristic for applications requiring a precise frequency in textile systems 6: Linear V/f characteristic with FCC for applications requiring a precise frequency in textile systems 7: Square-law V/f characteristic with ECO 19: V/f control without characteristic 20: Vector control without speed encoder 22: Torque control without speed encoder

Table 4- 8 Motor data according to the rating plate

Parameter	Description
p0100	<b>Motor standard IEC/NEMA</b> 0: Europe 50 [Hz]
p0300	<b>Motor type selection</b> 0: No motor 1: Induction motor 2: Synchronous motor
p0304	Motor voltage in [V]
p0305	Motor current in [A]
p0307	Motor frequency in [kW] or [hp]
p0310	Motor frequency in [Hz]
p0311	Motor speed in [rpm]
p0625	Ambient temperature of the motor in [°C]
p0640	Current limit of the motor in [A]

Changing the function of a terminal

Table 4- 9 Digital inputs

Parameter	Terminals CU240B-2	Terminals CU240E-2	Terminals CU230P-2	Signal	Command sources of important functions
p0722.0	5 / 69	5 / 69	5 / 69	DI 0	p0840 - ON/OFF (OFF1) p2103 - acknowledge faults p1055/p1056 - jog mode p1035/p1036 - motorized potentiometer p1020 ... p1023 - fixed speed setpoint p1230 - activate DC braking p2200 - enable technology controller
p0722.1	6 / 69	6 / 69	6 / 69	DI 1	
p0722.2	7 / 69	7 / 69	7 / 69	DI 2	
p0722.3	8 / 69	8 / 34	8 / 69	DI 3	
p0722.4	-	9 / 34	9 / 69	DI 4	
p0722.5	-	10 / 34	10 / 69	DI 5	

Table 4- 10 Changing the function of a digital input

Changing the function	Examples
<ol style="list-style-type: none"> <li>Select the required function marked using a "BI" parameter.</li> <li>Set this parameter to the value of the status parameter r0722.x of the required digital input.</li> </ol>	<p><i>Function:</i> Switch on motor via DI 2. <i>Setting:</i> p0840 = 722.2</p>
	<p><i>Function:</i> Acknowledge fault using DI 1. <i>Setting:</i> p3981 = 722.1</p>

Table 4- 11 Digital outputs (relay outputs)

Parameter	Terminals CU240B-2	Terminals CU240E-2	Terminals CU230P-2	Signal	Important status signals
p0730	18 / 19 / 20	18 / 19 / 20	18 / 19 / 20	DO 0	r52.2 - operation enabled (motor running)
p0731	-	21 / 22	21 / 22	DO 1	r52.3 - fault active
p0732	-	23 / 24 / 25	23 / 24 / 25	DO 2	r52.7 - alarm active

Table 4- 12 Changing the function of a digital output

Changing the function	Example
<ol style="list-style-type: none"> <li>Select the required function marked using a "BO" parameter.</li> <li>Set the parameter p073x of the required digital output to the value of the "BO" parameter.</li> </ol>	<p><i>Function:</i> Signal "Fault" on DO 1. <i>Setting:</i> p0731 = 52.3</p>

Table 4- 13 Analog inputs and temperature sensors

Parameter	Terminals CU240B-2	Terminals CU240E-2	Terminals CU230P-2	Signal	Possible settings
p0756 [0]	3 / 4	3 / 4	3 / 4	AI 0	0: Unipolar voltage input (0 V ...+10 V)
p0756 [1]	-	10 / 11	10 / 11	AI 1	1: Unipolar voltage input monitored (+2 V... +10 V)
p0756 [2]	-	-	50 / 51	AI 2	2: Unipolar current input (0 mA ...+20 mA)
p0756 [3]	-	-	52 / 53	AI 3	3: Unipolar current input monitored (+4 mA ...+20 mA)
					4: Bipolar voltage input (-10 V ...+10 V)
					6: Ni1000 temperature sensor (-50°C ... +150°C)
					7: PT1000 temperature sensor (-50 ...+250°C)
					8: No sensor connected
p0755 [0...3]	Analog inputs, actual value in percent				

4.3 Commissioning

Table 4- 14 Changing the function of an analog input

Changing the function	Examples
1. Select the required function marked using a "CI" parameter. 2. Set this parameter to the value of status parameter r0755.x of the analog input.	<i>Function:</i> AI 0 provides the setpoint for the PID controller. <i>Setting:</i> p2253 = 55[0]
	
Use parameter p0756[0] and the I/U switch on the front of the frequency converter to configure the analog input as voltage or current input.	

Table 4- 15 Analog outputs

Parameter	Terminals CU240B-2	Terminals CU240E-2	Terminals CU230P-2	Signal	Setting
p0771[0]	12 / 13	12 / 13	12 / 13	AO 0	Important status signals: 0: Analog output locked 21: Speed actual value 24: Output frequency smoothed 25: Output voltage smoothed 26: DC link voltage smoothed 27: Actual current value (smoothed absolute value)
p0771[1]	-	26 / 27	26 / 27	AO 1	
p0776[0, 1]	Analog outputs, type				0: Current output (0 mA ... +20 mA) 1: Voltage output (0 V ... +10 V) 2: Current output (+4 mA ... +20 mA)

Table 4- 16 Changing the function of an analog output

Changing the function	Examples
1. Select the required function marked using a "CO" parameter. 2. Set parameter p0771 of the analog output to the value of the "CO" parameter.	<i>Function:</i> Signal "Current" at AO 0. <i>Setting:</i> p0771 = 27
	
Use parameter p0776[0] to configure the analog input as voltage or current input.	

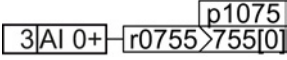
Table 4- 17 Motor temperature sensor interface

Parameter	Terminal	Abbreviation	Possible setting
p0601	14	T1 motor (+)	0: No sensor (factory setting) 1: PTC thermistor (→ P0604) 2: KTY84 (→ P0604) 4: ThermoClick sensor
	15	T2 motor (-)	
p0604	Motor temperature alarm threshold		

## Manuals and technical support

### 5.1 Manuals for your converter

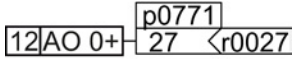
Table 5- 1 Manuals for your converter

Depth of the information	Manual	Contents	Languages	Download or order number
++	<b>Getting Started Guide</b>	(this manual)	English, German, Italian, French, Spanish, Chinese	Download manuals ( <a href="http://support.automation.siemens.com/WW/view/en/30563628/133300">http://support.automation.siemens.com/WW/view/en/30563628/133300</a> ) <b>SINAMICS Manual Collection</b> Documentation on DVD, order number 6SL3097-4CA00-0YGO
+++	<b>Operating instructions</b> for the following inverters: <ul style="list-style-type: none"> <li>• SINAMICS G120 with CU230P-2 Control Units</li> <li>• SINAMICS G120 with the CU240B-2 and CU240E-2 Control Units</li> </ul>	Installing, commissioning and operating the inverter. Setting the inverter functions. Technical data.		
+++	<b>Function Manual Safety Integrated</b> for the inverters SINAMICS G110M, G120, G120C, G120D and SIMATIC ET 200pro FC-2	Configuring PROFIsafe. Installing, commissioning and operating fail-safe functions of the inverter.		
+++	<b>Fieldbus function manual</b> for the SINAMICS G110M, G120, G120C and G120D inverters	Configuring fieldbuses.		
+++	<b>List Manual</b> for SINAMICS G120 inverters with the following Control Units: <ul style="list-style-type: none"> <li>• CU230P-2 Control Unit</li> <li>• CU240B-2 and CU240E-2 Control Units</li> </ul>	Graphic function block diagrams. List of all parameters, alarms and faults.		
+	<b>Getting Started Guide</b> for the following SINAMICS G120 Power Modules: <ul style="list-style-type: none"> <li>• PM230 IP20</li> <li>• PM230 IP55</li> <li>• PM240, PM250 and PM260</li> <li>• PM240-2</li> </ul>	Installing the Power Module		
+	<b>Installation Instructions</b> for reactors, filters and braking resistors	Installing components	English	

5.2 Product support

Depth of the information	Manual	Contents	Languages	Download or order number
+++	<b>Hardware Installation Manual</b> for the following SINAMICS G120 Power Modules: <ul style="list-style-type: none"> <li>• PM230 IP20</li> <li>• PM230 IP55</li> <li>• PM240</li> <li>• PM240-2</li> <li>• PM250</li> <li>• PM260</li> <li>• PM330</li> </ul>	Installing power modules, reactors and filters. Maintaining power modules.	German, English	
+++	<b>Operating Instructions</b> for the following Operator Panels: <ul style="list-style-type: none"> <li>• BOP-2</li> <li>• IOP</li> </ul>	Operating Operator Panels, door mounting kit for mounting of IOP.		

## 5.2 Product support

Table 5- 2 Technical support

France	Germany	Italy	Spain	Great Britain
+33 (0) 821 801 122	+49 (0)911 895 7222	+39 (02) 24362000	+34 902 237 238	+44 161 446 5545
Other service telephone numbers: Product support ( <a href="http://www.siemens.com/automation/service&amp;support">http://www.siemens.com/automation/service&amp;support</a> )				





## Further information

SINAMICS inverters:  
[www.siemens.com/sinamics](http://www.siemens.com/sinamics)

Safety Integrated:  
[www.siemens.com/safety-integrated](http://www.siemens.com/safety-integrated)

PROFINET:  
[www.siemens.com/profinet](http://www.siemens.com/profinet)

Siemens AG  
Industry Sector  
Drive Technologies  
Motion Control Systems  
Postfach 3180  
91050 ERLANGEN  
GERMANY

Subject to change without prior notice  
© Siemens AG 2010-2014

Scan the QR code for  
additional information  
on SINAMICS G120.



[www.siemens.com/drives](http://www.siemens.com/drives)