

SIEMENS



Reliable connections

A worldwide unique product range of
high quality and flexibility

FLENDER COUPLINGS

[siemens.com/couplings](https://www.siemens.com/couplings)

High degree of standardization and great product mix depth



Torsionally rigid gear couplings
Pages 4–5



Torsionally rigid all-steel couplings
Pages 6–7



Torsionally flexible couplings
Pages 8–9



Highly flexible couplings
Pages 10–11



Fluid couplings
Pages 12–13



Couplings for wind turbines
Pages 14–15



Couplings for railway vehicles
Pages 16–17

In a drive train, couplings are of great importance. They must be robustly designed so that they can work reliably even under extreme conditions. Our couplings are of first-class quality and available worldwide – our contribution to the reliability of processes in your plant.

FLENDER® couplings

With great experience in numerous industries and international performance, Siemens is the right partner for you for all questions concerning power transmission technology. We supply high-quality FLENDER couplings for almost all industrial branches. They either originate from a wide range of standard couplings or are application-specific solutions.

As one of the most important manufacturers of mechanical couplings, Siemens offers the most varied types and numerous sizes and assemblies of the highly standardized FLENDER couplings. The supply comprises couplings in a torque range between 10 and 10,000,000 Nm.

Safety and quality

When designing couplings, FLENDER attaches great importance to safety and reliability. The coupling features are regularly tested on our test stands. With extensive quality assurance measures we ensure that the product features remain the same. Processes, manufacturing sequences, and quality inspections are determined in the respective current guidelines.

Maintenance

Some FLENDER coupling series are maintenance-free, others have long maintenance intervals. Wearing parts can be easily replaced and are available worldwide. Thus, standstill periods are reduced to a minimum.

Environment

Responsible handling of resources plays an important role for us. With a great portion of in-house production, the couplings are made at our works in Germany. For additional purchases, we prefer European manufacturers who attach great importance to quality, availability, and environmental protection.

Price, delivery time, and availability

FLENDER couplings are offered at attractive prices with the shortest delivery time possible. The maintenance of product features and quality levels as well as keeping to the delivery dates have the highest priority. Excellent logistics of the after-sales service mean that wearing and spare parts frequently can be delivered worldwide within a few hours.

Strong and reliable

Torsionally rigid gear couplings – the ZAPEX series



Robust couplings made of high-quality quenched and tempered steel with good power-weight ratio are ideal for the severest operating conditions.

ZAPEX® gear couplings

Gear couplings consist of two hubs with external gear teeth and are mounted on the shaft ends of the machines to be connected. The torque is transmitted via the coupling teeth. The teeth are crowned so that angular displacement is possible at each gear teeth level. The radial displacement is absorbed via the distance between the two gear teeth levels. The internal teeth of the flanged sleeves are significantly broader than the external teeth, which permits a comparably large axial misalignment.

The compact ZAPEX couplings are made from high-quality quenched and tempered steel and are manufactured according to the modular system. The hubs of the standard types can be replaced with multi-purpose hubs. The multi-purpose hubs are significantly longer and can be modified according to customers' wishes.

The ZW series includes 31 sizes, 14 of which have been standardized and are in stock for a torque range of up to 250,000 Nm and maximum bores up to 275 mm. In addition to the standard product range, couplings up to 10,000,000 Nm can be made according to customer requests.

The ZN series is available ex stock in twelve sizes for torques up to 162,500 Nm and maximum bores up to 288 mm.



ZAPEX ZN

Features:

- Double-jointed gear coupling compensates for angular, radial, and axial shaft misalignments
- Low restoring forces in the case of shaft misalignments
- Small dimensions; can be used at high shock loads; large safety reserves
- Suitable for both directions of rotation

Fields of application:

- Heavy machinery construction
- Metallurgical engineering
- Materials handling technology
- Pumps
- Compressors
- Cranes

Significantly increased torque
Larger bores possible
Solutions tailored to requirements
Excellent price-performance ratio
Very short delivery times
Individual hubs
Extremely rugged design
Broad range of types
Low restoring forces in the case of high permissible shaft misalignment
 Suitable for potentially explosive environments

Versatile and compact

Torsionally rigid all-steel couplings – the ARPEX series



- No circumferential backlash
- Maintenance-free
- Suitable for aggressive ambient conditions
- Wide range of types
- Specific solutions designed to customer needs
- Low restoring forces with high permissible shaft misalignment
- Particularly suitable for high or low ambient temperatures
-  Suitable for explosive environments



ARPEX® all-steel couplings are very compact and stand out due to their particularly good power-weight ratio. Their versatility makes them suitable for universal use.

ARPEX all-steel couplings

In these all-steel couplings, the torque is transmitted by torsionally rigid, flexible discs. The discs are jointed together with bushes and rings to form a compact disc pack which ensures easy and reliable installation.

Two disc packs connected to a spacer allow compensation of shaft misalignments in axial, radial, and angular directions. Couplings with one disc pack can only compensate angular and axial misalignments.

Our all-steel couplings are available in eight different series for torques from 5 Nm up to 10,000,000 Nm. They are ideal for all applications where reliable and uniform transmission of torque is required, even in the case of shaft misalignment. The standard ambient temperature range is between $-40\text{ }^{\circ}\text{C}$ and $+280\text{ }^{\circ}\text{C}$.

Features:

- Torsionally rigid all-steel couplings without backlash
- Compensation for radial, angular, and axial shaft misalignment by means of two flexible disc packs
- Maintenance-free disc packs made from stainless spring steel are not subject to wear
- Easy to assemble owing to compact design

Fields of application:

- Universal coupling for paper and printing machines, compressors, power engineering, the petrochemical and chemical industries, conveyors, the cement industry, marine propulsions, ventilators, pump drives, generators, turbines, turbo-compressors, boiler feed pumps, test stands, cooling tower fans, and automatic control systems
- Wide range of applications also in the design with torque limiter

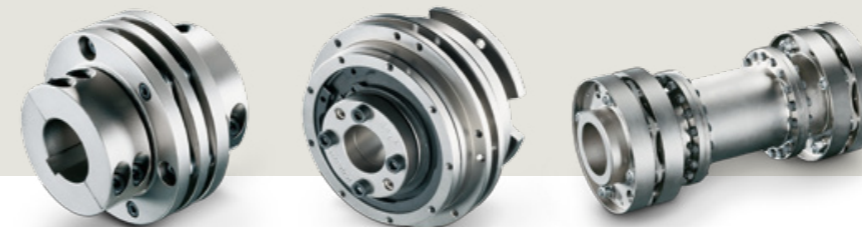

Thanks to the wide range of types, ARPEX couplings can be used in many different applications.



Robust and proven a million times

Torsionally flexible couplings – the N-EUPEX, RUPEX, and BIPEX series

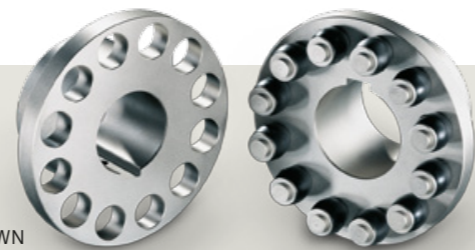

RUPEX RWN

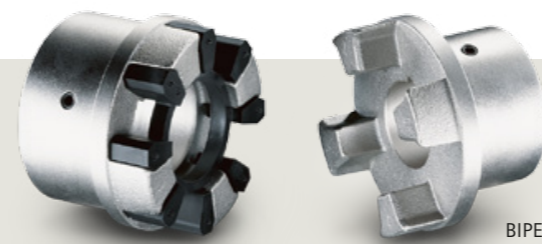

BIPEX BWN

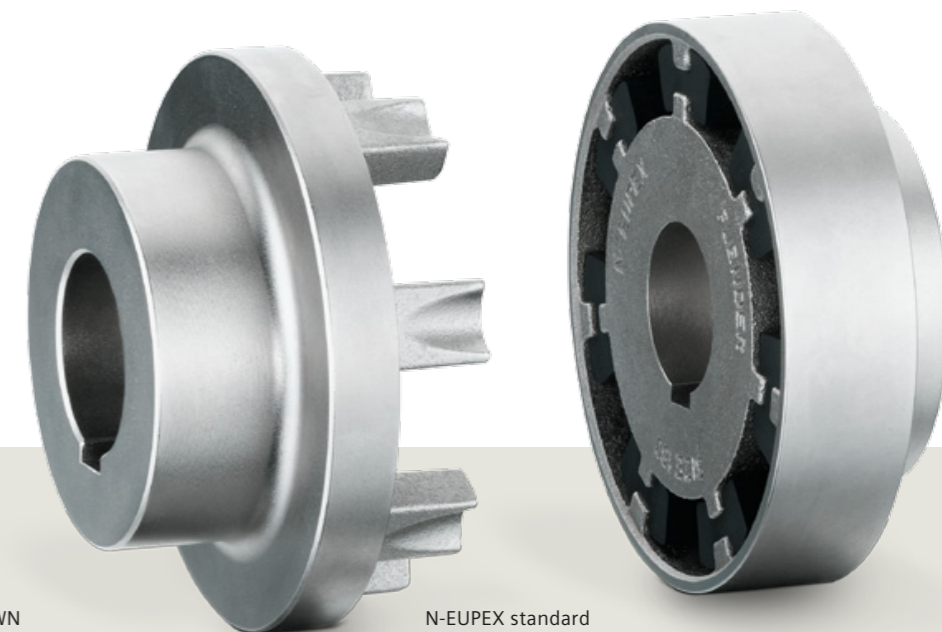

N-EUPEX standard

The versatile, flexible couplings are used in the whole field of mechanical engineering. They are suitable for plug-in assembly and easy to install. Their flexible elements compensate for shaft misalignments and absorb moderate shock loads of motor and driven machinery.

Flexible couplings

In addition to connecting motor and driven machinery, flexible couplings are often mounted on the gear unit input and gear unit output shafts. They consist of hub parts which are mounted on the shafts to be connected. The hub parts are connected by flexible elements mainly made of NBR, HNBR, or NR.

Depending on the type, additional components can be used, e.g. spacers, brake discs, or brake drums.

N-EUPEX®

The N-EUPEX is a universal coupling made of high-quality cast iron GG-25. The flexible elements are resistant to many media. The metal pins and the flexible elements are designed so that only minor wear occurs in the case of permissible misalignment.

A distinction is made between the overload-keeping fail-safe series (N-EUPEX) and the overload-disconnecting series without a fail-safe device (N-EUPEX DS).

N-EUPEX DS couplings are preferably used where the input and output side must be disconnected upon failure of the flexible elements, or where a maintenance-free coupling is required.

BIPEX®

BIPEX couplings from the standard BWN series consist of two identical hub parts (material GG-25). They are connected with a flexible ring that is fitted with very low circumferential backlash and leads to a progressive torsional stiffness. The BIPEX coupling is fail-safe, i.e. if the flexible ring is worn out, the cast claws of the two hub parts ensure emergency running. BIPEX couplings are very compact. They are available ex stock in 13 sizes for a torque range from 13.5 Nm to 3,700 Nm.

RUPEX®

The RUPEX hub parts are connected by flexible, barrel-shaped buffers and buffer pins with a conical seat. The barrel shape of the buffers facilitates mounting and guarantees that they are almost resistant to wear during operation. Different buffer designs are available ex stock. The RUPEX coupling is available ex stock in cast iron and in steel design up to size 500. Sizes with outside diameters up to 2,000 mm are made to order.

We also offer many series covering special customer needs. In addition to couplings connecting flange and shaft, variants with a brake disc or brake drum are also frequently required.

- Proven in millions of drives worldwide
- Economical and quickly available worldwide
- Easy to install, plug-in assembly
- Wide range of types
-  N-EUPEX and RUPEX suitable for explosive environments



Simple examination of the condition of the flexible element in the N-EUPEX coupling by wear indicator.

Flexible and adaptable

Highly flexible couplings – the ELPEX, ELPEX B and ELPEX S series



ELPEX



ELPEX B



ELPEX S

ELPEX® couplings have no circumferential backlash. Because of their low torsional stiffness and their good damping properties, these couplings are particularly suitable for the connection of machines with very non-uniform torque characteristics or with large shaft misalignments.

ELPEX

The ELPEX couplings made from grey cast iron (GG-25) or steel are available in nine sizes for torques up to 90,000 Nm. The flexible rings are made of high-quality natural rubber in which the fibre inserts, which transmit the torque, are vulcanized.

Fields of application:

- Drives with periodically exciting systems, such as internal combustion engines, piston compressors, and piston pumps
- Drives with high shock loads or large shaft misalignments (e.g. in the cement industry)
- Heavy machinery construction

Positive influence on the torsional vibration behavior of the drive

Distinct reduction of shock loads, e.g. during starting or short circuit of motor

Large shaft misalignments are permissible

Nearly maintenance-free

Spare rubber elements available ex stock



ELPEX-S couplings in explosion-proof design

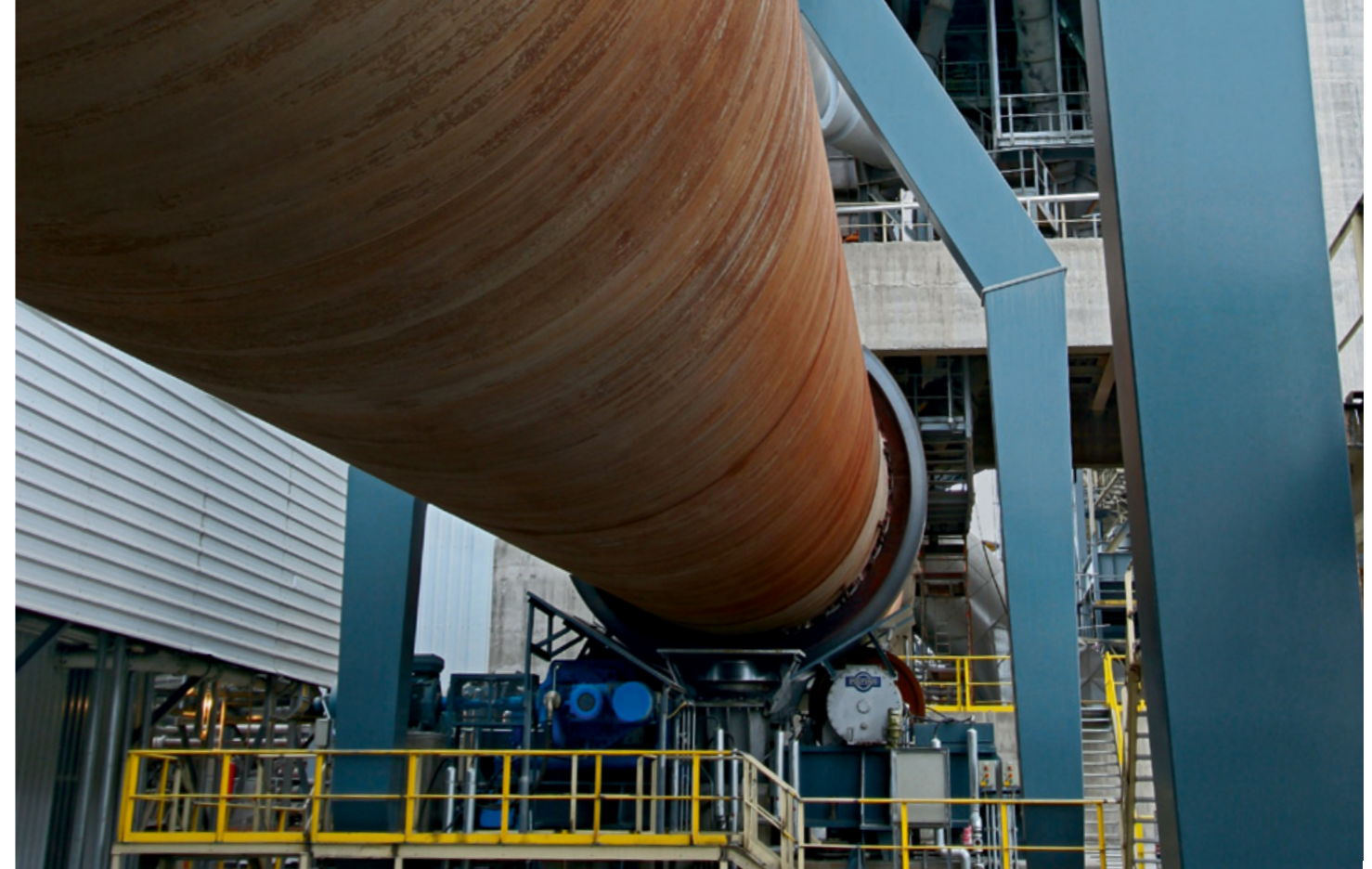

ELPEX B

Siemens supplies ELPEX B couplings in 15 sizes for nominal torques between 24 Nm and 14,500 Nm. The coupling hubs are made of high-quality nodular graphite cast iron GGG-40 or steel. The torque is transmitted by a flexible tyre reinforced with a cord ply.

Fields of application:

- Metallurgical engineering
- Materials handling technology
- Pumps
- Compressors

ELPEX S

Of the ELPEX S coupling series, twelve sizes have been standardized for a torque range between 330 Nm and 63,000 Nm. The inside diameter of the rubber disc element is vulcanized on a flange.

The flange serves to take a taper bush or a hub. To adapt the torsional stiffness of the ELPEX S coupling, rubber elements with different grades of hardness are available.

Fields of application:

- Drives comprising internal combustion engines; piston compressor and cement mill drives



- Soft starting
- Overload protection
- Vibration decoupling
- Easy to maintain

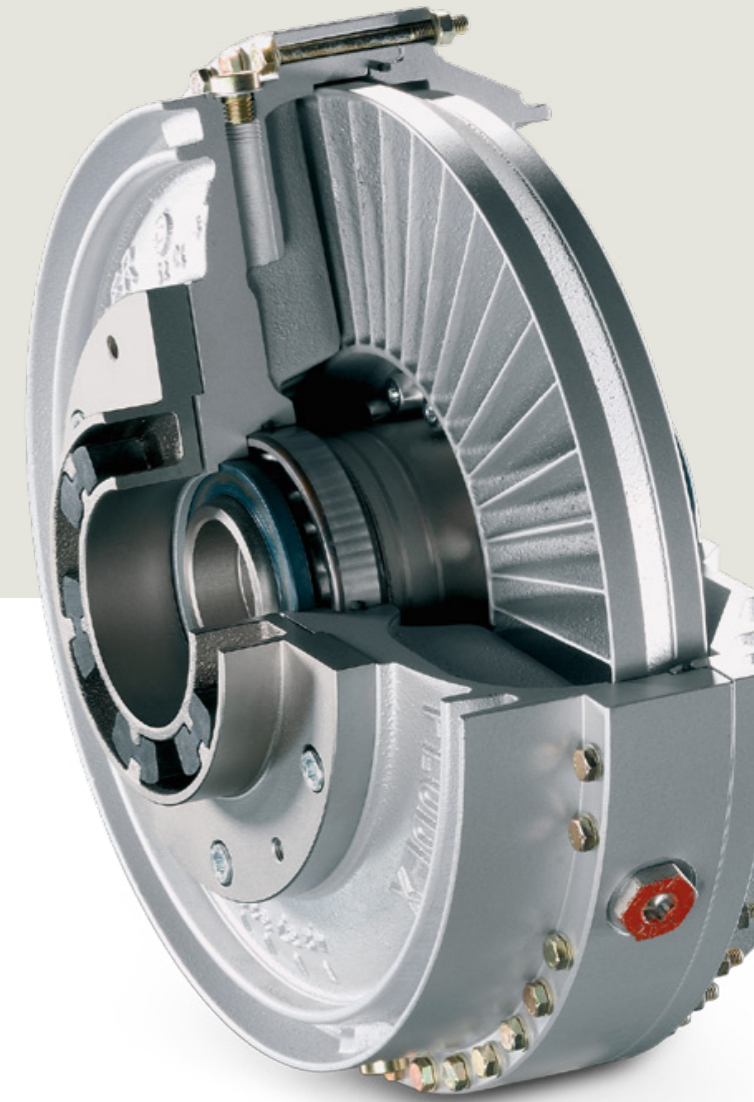

Soft and safe

Fluid couplings – the FLUDEX series

FLUDEX® couplings limit the starting and maximum torques in a drive train and use the operating slip for their function as a starting aid for the motor, overload protection in the case of trouble, and a vibration decoupler.

FLUDEX fluid couplings

FLUDEX couplings are hydrodynamic fluid couplings operating according to the Föttinger principle. The coupling parts on the input and output side are not mechanically connected. The torque is transmitted by the fluid movement in the coupling, accelerated by the radial blades. When starting up with large masses, the drive train is accelerated with only the torque determined by the coupling characteristic. The start-up process is time-delayed; the driven machine is started up softly and without shock loads.

All our fluid couplings are designed with radial blades and are therefore suitable for both directions of rotation and reversing operation. They can be mounted in horizontal, inclined, and vertical positions.

FLUDEX couplings have an optimized working chamber allowing torque-limited start-up and guaranteeing very low operating slip at nominal load. Four series with different types and 14 sizes are available, designed according to the modular system, for power ratings up to 2,500 kW.

Under extreme operating conditions, such as overload or blockage of the driven machine, the effect of the motor mass is eliminated and the maximum torque load of the drive train is limited by the FLUDEX coupling. In this case, the coupling acts as a load-keeping torque limiter until the drive is disconnected by the motor-speed control or the operating control system of the coupling. Furthermore, in the case of torsional vibration excitation the FLUDEX coupling acts as a decoupler.

Torsional vibration excitations with a frequency of > 5 Hz are practically absorbed by the coupling. To compensate for shaft misalignments, the FLUDEX coupling is combined with a flexible coupling, e.g. of the N-EUPEX type.

Fields of application:

- FLUDEX couplings are used in conveyor drives, e.g. belt conveyors, bucket elevators, and chain conveyors
- In heavy industry, they are used, for example, in drives for bucket wheels, crushers, roller presses, mixers, large ventilators, boiler feed pumps, high-capacity compressors, centrifuges, and in auxiliary drives for mills

Features:

- Soft and shock-free starting, and acceleration of large masses during load-relieved start of motor
- Torque limitation during start-up and in the case of overload
- Excellent decoupling of vibrations and shock damping
- Torque transmission without wear
- Allows start-up of internal combustion engines with connected load

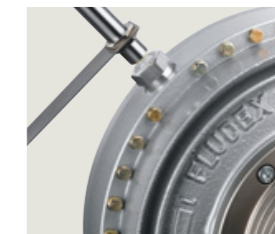

A thermal operating control system prevents overheating of the FLUDEX coupling.



The specified operating condition of a FLUDEX coupling can be monitored by a non-contacting and maintenance-free EOC system.

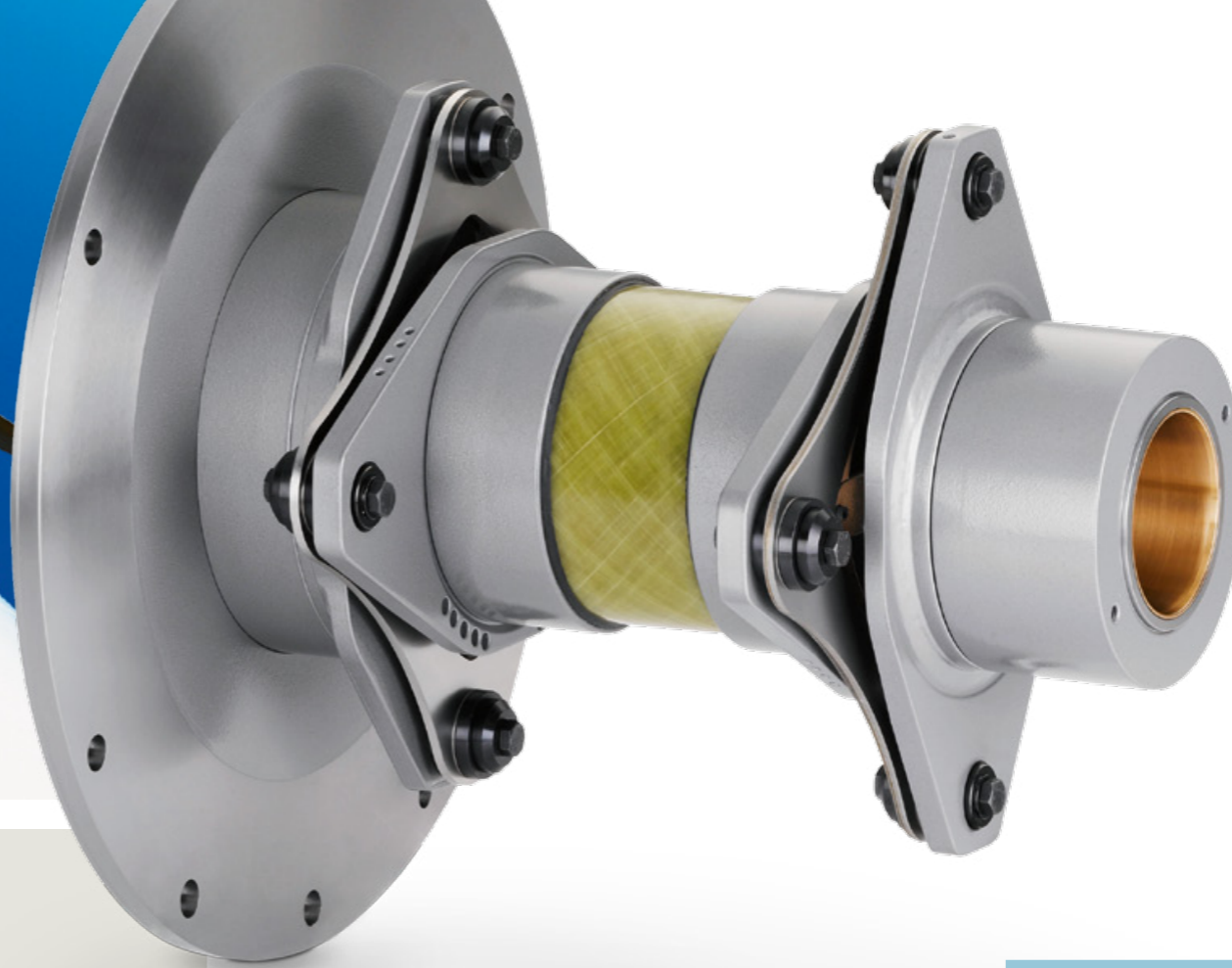

Connections at the highest level

FLENDER couplings for wind turbines

Coupling solutions for wind turbines are designed according to customer needs. The coupling connects the high-speed gear unit shaft with the generator shaft.

25 years of experience in the wind power industry

Siemens has 25 years of experience as a supplier of drive components for wind turbines. As a specialist in complex solutions, we ensure the smooth interaction of the coordinated and complex gear unit, coupling, generator, as well as inverter subassemblies. Worldwide, many thousands of couplings have already been installed in wind turbines.

Since gear units and generators in wind turbines are flexibly mounted, the FLENDER coupling compensates for shaft misalignments of up to 20 mm in axial and radial directions.

The all-steel coupling specifically designed for wind turbines is entirely maintenance-free. On the gear unit side, it is mostly provided with a brake disc. The coupling spacer should be electrically insulating and therefore is made of a glass-fibre-reinforced plastic tube.

Our couplings usually comprise the subassemblies, gear unit-side hub with brake disc, spacer, and generator-side hub. This means that each component of the coupling can be easily removed on the wind turbine.

Features with slip hub or slip spacer:

- Overload protection from briefly occurring torque impulses
- Precision of the slip torque approx. +/-15%
- Resistant to wear even with hundreds of briefly occurring overloads
- 100% test of the slip torque at the factory

Features with conical bolt connection:

- Positive torque transmission
- Easy assembly; use of hydraulic tools no longer required
- Easy disassembly
- Improved balancing property because of higher centering precision
- Bolt connection made of high-quality quenched and tempered steels

- Maintenance-free and robust
- Torsionally rigid
- Compensates for very large shaft misalignments
- Protects coupled machines against overload damage by slip hub or slip spacer

Patented conical bolt connection

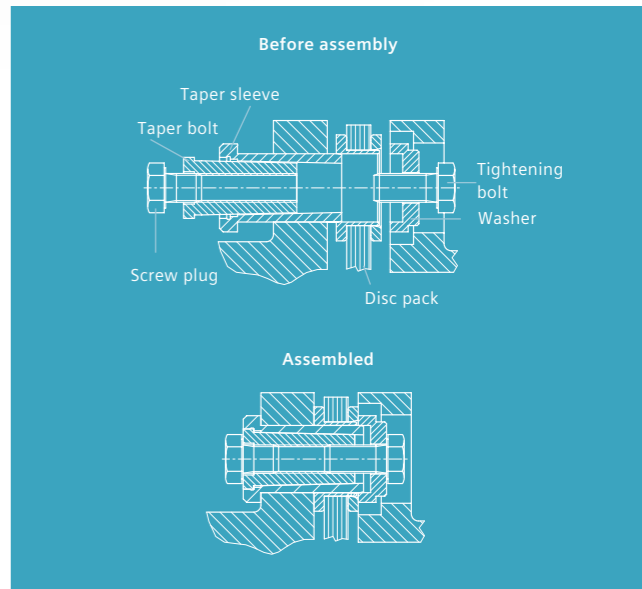

Good connections thanks to quality

FLENDER railway couplings

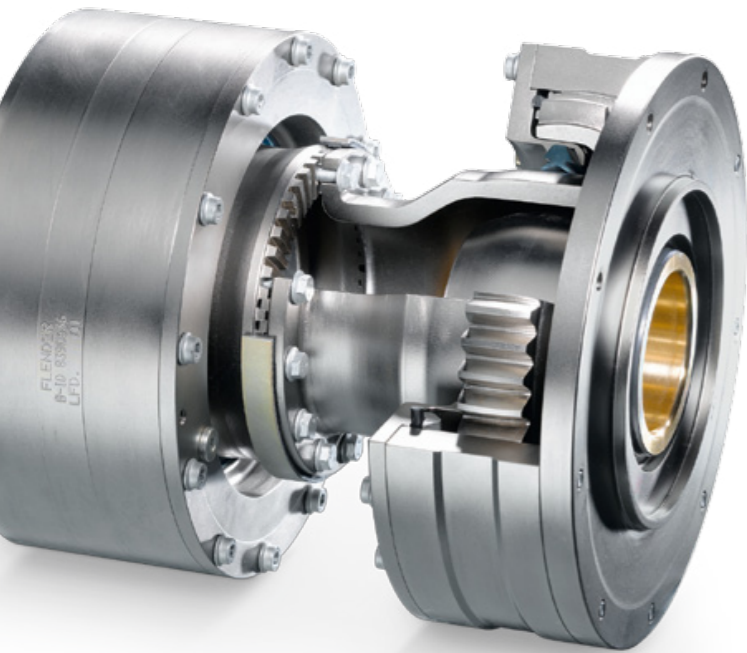

Whether between motor and gear unit or between gear unit and axle; whether within the scope of a complete drive solution from a single supplier or as a system-integrated individual connection – FLENDER couplings can be found almost everywhere and have proven themselves in thousands of drive applications worldwide.

Couplings for railway vehicles

With regard to FLENDER couplings, Siemens combines great product mix depth with optimum product availability. As a specialist in axle drives, we look at the drive train as an integral whole. From trams to high-speed trains, from modular standard to custom-made solutions; the optimum coordination of gear unit and coupling, the high degree of standardization of our products, and the multitude of coupling types enable that they can be used in the most different types of vehicles.

Couplings for railway vehicles must meet many requirements. This is why the coupling elements are designed and calculated according to the latest trends. The products are always state-of-the-art technology.

Coupling solutions between motor and gear unit

Gear couplings from the ZBG series

ZBG couplings permit very large shaft misalignments. These couplings are very robust and are provided with a long-life grease lubricant. As an option, we offer couplings with overload protection.

Membrane couplings from the MBG series

MBG couplings are torsionally rigid all-steel couplings permitting only very small shaft misalignment. These couplings are used in trams.

Coupling solutions between gear unit and axle

Connecting rod couplings from the LBK series

With the radial arrangement of the rubber elements of the LBK couplings, two angle joints are created. The connecting rod couplings have a split spacer and can form a very compact connection with the gear unit.

Cardan couplings from the GKG series

GKG couplings are suitable for both trams and high-speed trains. Spherical rubber elements permit very large shaft misalignments and thus displacement of the axle and gear unit.

Very high quality standard

Components can be traced back 100%

Wide product range

Supplied as subassembly with FLENDER axle drive

All-round services

The wide range at a glance

Our couplings are available in many types and sizes



BIPEX N-EUPEX RUPEX	BIPEX	N-EUPEX	N-EUPEX DS	RUPEX RWN/RWS
	Flexible couplings			
	Claw coupling	Pin coupling	Pin coupling	Pin and bush coupling
Properties	Fail-safe, torsionally flexible, damping	Fail-safe, torsionally flexible, damping	W/o fail-safe device, torsionally flexible, damping	Fail-safe, torsionally flexible, damping
Nominal torque/power rating [Nm or kW]	13.5 Nm ... 3,700 Nm	19 Nm ... 62,000 Nm	19 Nm ... 21,200 Nm	200 Nm ... 1,300,000 Nm
Perm. peripheral speed [m/s]	36 m/s	36 m/s	36 m/s	40/60 m/s
Temp. at place of installation [°C]	-30 °C ... +80 °C	-50 °C ... +100 °C	-30 °C ... +80 °C	-50 °C ... +100 °C
Perm. angular misalignment [°]	0.1°	0.2°	0.2°	0.2°



ARPEX	ARPEX ARP-6	ARPEX ARS/ARC	ARPEX ARW-4/6	ARPEX ART-6/8/10
	Torsionally rigid couplings			
	All-steel coupling	All-steel coupling	All-steel coupling	All-steel coupling
Properties	Fail-safe, torsionally rigid, double-jointed	Fail-safe, torsionally rigid, double-jointed	Fail-safe, torsionally rigid, double-jointed	Fail-safe, torsionally rigid, double-jointed
Nominal torque/power rating [Nm or kW]	100 Nm ... 17,000 Nm	170 Nm ... 1,450,000 Nm	92 Nm ... 80,000 Nm	1,000 Nm ... 535,000 Nm
Perm. peripheral speed [m/s]	100 m/s	55/100 m/s	55 m/s	200 m/s
Temp. at place of installation [°C]	-40 °C ... +280 °C	-40 °C ... +280 °C	-40 °C ... +280 °C	-40 °C ... +280 °C
Perm. angular misalignment [°]	0.7°	0.7°/0.4°/0.3°/0.2°	3°	0.35°/0.25°/0.18°

Your advantages

- FLENDER couplings are particularly reliable, low-maintenance products which help to reduce investment and operating costs
- FLENDER couplings from the standard range can be used for many drives and are thus quickly available worldwide
- Even specially developed solutions are convincing thanks to first-class quality and exceptional service life



ELPEX	ELPEX B	ELPEX S	ELPEX Standard
	Highly flexible couplings		
	Rubber tyre coupling	Rubber disc coupling	Ring coupling
Properties	Fail-safe, highly flexible, damping	Fail-safe, highly flexible, damping	W/o fail-safe device, highly flexible, damping
Nominal torque/power rating [Nm or kW]	24 Nm ... 14,500 Nm	330 Nm ... 63,000 Nm	1,600 Nm ... 90,000 Nm
Perm. peripheral speed [m/s]	35 m/s	66 m/s	36/60 m/s
Temp. at place of installation [°C]	-50 °C ... +70 °C	-40 °C ... +120 °C	-40 °C ... +80 °C
Perm. angular misalignment [°]	4°	0.5°	0.5°



FLUDEX ZAPEX	FLUDEX	ZAPEX ZW	ZAPEX ZN
	Hydrodynamic couplings	Torsionally rigid couplings	
	Fluid coupling	Gear coupling	Gear coupling
Properties	Ability to slip, hydrodynamic	Fail-safe, torsionally rigid, double-jointed	Fail-safe, torsionally rigid, double-jointed
Nominal torque/power rating [Nm or kW]	0.5 kW ... 2,500 kW	1,300 Nm ... 7,200,000 Nm	1020 ... 162,500 Nm
Perm. peripheral speed [m/s]	80 m/s	60 m/s	60 m/s
Temp. at place of installation [°C]	-40 °C ... +50 °C	-20 °C ... +80 °C	-20 °C ... +80 °C
Perm. angular misalignment [°]	0.2°	1°	0.5°

You will find more information about our economical coupling solutions at:
www.siemens.com/couplings

For more information please contact:
www.siemens.com/automation/partner

You will find additional information brochures and technical descriptions
under Support in our Internet pages

Siemens AG
Industry Sector
Mechanical Drives
Alfred-Flender-Straße 77
46395 BOCHOLT
GERMANY

Subject to change without prior notice 1111
Order No.: E20001-A60-P900-V2-7600
DISPO 27904
ROMEN GD.MD.ST.CPLX.52.2.01 WS 11113.0
Printed in Germany
© Siemens AG 2011

The information provided in this brochure contains merely general descriptions or characteristics of performance which in actual case of use do not always apply as described or which may change as a result of further development of the products. An obligation to provide the respective characteristics shall only exist if expressly agreed in the terms of the contract.

All product designations may be trademarks or product names of Siemens AG or supplier companies whose use by third parties for their own purposes could violate the rights of the owners.