



Installation and Operating instructions for
C6015-0010
“Economy” control cabinet Industrial PC

Version: 1.2
Date: 2018-02-22

BECKHOFF

Table of contents

1	Foreword	3
1.1	Notes on the Documentation	3
1.1.1	Liability Conditions	3
1.1.2	Trademarks	3
1.1.3	Patent Pending	3
1.1.4	Copyright	3
1.1.5	State at Delivery	3
1.1.6	Delivery conditions	3
1.2	Description of safety symbols	4
1.3	Basic safety measures	5
1.4	Operator's obligation to exercise diligence	6
1.4.1	National regulations	6
1.4.2	Procedure in the event of a fault	6
1.4.3	Operator requirements	6
2	Product Description	7
2.1	Product overview	7
2.2	Appropriate Use	8
2.3	Access to the connectors	8
2.4	Interfaces	9
2.4.1	Power Supply (X101)	9
2.4.2	Network connection LAN1, LAN2 (X102, X103)	9
2.4.3	DisplayPort (X104)	9
2.4.4	USB2.0 output (X105)	9
2.4.5	USB3.0 output (X106)	9
2.4.6	Protective Earthing (PE)	9
2.5	Access to the battery and the memory device	11
2.6	Status LEDs	12
3	Installation	13
3.1	Transport and Unpacking	13
3.1.1	Transport	13
3.1.2	Unpacking	13
3.2	Installation of the PC in the control cabinet	14
3.2.1	Flexible mounting mechanism	14
3.2.2	Preparation of the control cabinet	14
3.3	Power Supply of the Industrial PC	15
3.3.1	Pin assignment of the connector	15

3.3.2	Cable Cross Sections	15
3.3.3	Check voltage rating and connect	15
3.3.4	Configuration for shutting down the PC	16
3.3.5	PC_ON and Power Status functions	16
3.4	Connecting the Industrial PC	17
3.4.1	Connecting cables	17
3.4.2	Check voltage rating and connect	17
3.4.3	Earthing measures	17
4	Operating Instructions	18
4.1	Switching the Industrial PC on and off	18
4.1.1	Switch on	18
4.1.2	Shutting down and switching off	18
4.1.3	First switching on and driver installation	18
4.2	Servicing and maintenance	19
4.2.1	Cleaning of the Industrial PC	19
4.2.2	Maintenance	19
4.2.3	Replacing the Battery on the Motherboard	19
4.3	Emergency procedures	19
4.4	Shutting down	19
4.4.1	Disposal	19
5	Troubleshooting	20
6	Assembly dimensions	21
7	Technical Data	23
8	Appendix	24
8.1	Beckhoff Support and Service	24
8.1.1	Beckhoff branches and partner companies	24
8.1.2	Beckhoff company headquarters	24
8.2	Approvals for USA and Canada	25
8.3	FCC Approvals for the United States of America	25
8.4	FCC Approval for Canada	25

1 Foreword

1.1 Notes on the Documentation

This description is only intended for the use of trained specialists in control and automation engineering who are familiar with the applicable national standards. It is essential that the following notes and explanations are followed when installing and commissioning these components.

The responsible staff must ensure that the application or use of the products described satisfy all the requirements for safety, including all the relevant laws, regulations, guidelines and standards.

1.1.1 Liability Conditions

The documentation has been prepared with care. The products described are, however, constantly under development. For that reason the documentation is not in every case checked for consistency with performance data, standards or other characteristics. In the event that it contains technical or editorial errors, we retain the right to make alterations at any time and without warning. No claims for the modification of products that have already been supplied may be made on the basis of the data, diagrams and descriptions in this documentation.

All pictures shown in the documentation are exemplary. Illustrated configurations can differ from standard.

1.1.2 Trademarks

Beckhoff®, TwinCAT®, EtherCAT®, Safety over EtherCAT®, TwinSAFE® and XFC® are registered trademarks of and licensed by Beckhoff Automation GmbH.

Other designations used in this publication may be trademarks whose use by third parties for their own purposes could violate the rights of the owners.

1.1.3 Patent Pending

The EtherCAT Technology is covered, including but not limited to the following patent applications and patents: EP1590927, EP1789857, DE102004044764, DE102007017835 with corresponding applications or registrations in various other countries.

The TwinCAT Technology is covered, including but not limited to the following patent applications and patents: EP0851348, US6167425 with corresponding applications or registrations in various other countries.

1.1.4 Copyright

© Beckhoff Automation GmbH & Co. KG.

The reproduction, distribution and utilization of this document as well as the communication of its contents to others without express authorization are prohibited. Offenders will be held liable for the payment of damages. All rights reserved in the event of the grant of a patent, utility model or design.

1.1.5 State at Delivery





All the components are supplied in particular hardware and software configurations appropriate for the application. Modifications to hardware or software configurations other than those described in the documentation are not permitted, and nullify the liability of Beckhoff Automation GmbH & Co. KG.

1.1.6 Delivery conditions

In addition, the general delivery conditions of the company Beckhoff Automation GmbH & Co. KG apply.

1.2 Description of safety symbols

The following safety symbols are used in this operating manual. They are intended to alert the reader to the associated safety instructions.

 DANGER	<p>Acute risk of injury!</p> <p>If you do not adhere the safety advise adjoining this symbol, there is immediate danger to life and health of individuals!</p>
 WARNING	<p>Risk of injury!</p> <p>If you do not adhere the safety advise adjoining this symbol, there is danger to life and health of individuals!</p>
 CAUTION	<p>Hazard to individuals!</p> <p>If you do not adhere the safety advise adjoining this symbol, there is obvious hazard to individuals!</p>
 Attention	<p>Hazard to devices and environment</p> <p>If you do not adhere the notice adjoining this symbol, there is obvious hazard to materials and environment.</p>
 Note	<p>Note or pointer</p> <p>This symbol indicates information that contributes to better understanding.</p>

1.3 Basic safety measures

Before the Industrial PC is switched off, software that is running must be properly closed. Otherwise it is possible that data on the storage medium is lost. Please read the section [Switching the Industrial PC on and off](#).

 Attention	<p>Switch off all parts of the equipment, then uncouple the fieldbus</p> <p>Before opening the housing, and whenever the Industrial PC is not being used for control purposes (such as during functional checks after a repair), all parts of the equipment must first be switched off, after which the Industrial PC is to be disconnected from the equipment.</p>
---	--

Pulling out the fieldbus connection plug uncouples the PC (optional).
Items of equipment that have been switched off must be secured against being switched on again.

The Industrial PC's power supply unit must be supplied with 24 V_{DC}.

 Attention	<p>Do not exchange any parts when under power</p> <p>When components are being fitted or removed, the supply voltage must be switched off.</p> <p>Fitting work on the Industrial PC can result in damage:</p> <ul style="list-style-type: none">• if metal objects such as screws or tools fall onto operating circuit boards.• if connecting cables internal to the PC are removed or inserted during operation.• if plug-in cards are removed or inserted when the PC is switched on.
---	--

1.4 Operator's obligation to exercise diligence

The operator must ensure that

- the product is only used as intended (see chapter [Product Description](#))
- the product is in a sound condition and in working order during operation
- the product is operated, maintained and repaired only by suitably qualified and authorized personnel
- the personnel is instructed regularly about relevant occupational safety and environmental protection aspects, and is familiar with the operating manual and in particular the safety notes contained herein
- the operation manual is in good condition and complete, and always available for reference at the location of the product.



Attention

Only trained persons may open the Industrial PC housing

The operator is responsible for ensuring that only trained electrical staff opens the housing of the Industrial PC.

1.4.1 National regulations

Depending on the type of machine and plant in which the Industrial PC is used, national regulations governing the controllers of such machines will apply, and must be observed by the operator. These regulations cover, amongst other things, the intervals between inspections of the controller. The operator must initiate such inspections in good time.

1.4.2 Procedure in the event of a fault

In the event of faults at the Industrial PC, the list in the section [Troubleshooting](#) can be used to determine the measures to be taken.

1.4.3 Operator requirements

Anyone who uses the Industrial PC must have read these operating instructions and must be familiar with all the functions of the software installed on the Industrial PC to which he has access.

2 Product Description

2.1 Product overview



C6015-0010 | “Economy” control cabinet Industrial PC

With the C6015-0010 “Economy” Industrial PC for control cabinet installation, Beckhoff is extending its existing range of entry-level products by the currently most compact Industrial PC. Besides an excellent price-performance ratio, the IPC offers all common industry standard features such as a high temperature range, EtherCAT compatibility and high resistance to vibration and shocks. Equipped with an integrated Intel® Atom™ CPU with up to four cores, it provides high performance reserves. Only processors from the Embedded line with long-term availability are used in the C6015-0010 series, ensuring a future-proof investment for the user.

With universal multi-core support, the C6015-0010 can be used simultaneously for high-performance automation, visualisation and communication applications. Its flexible installation options with virtually free orientation of the PC allow various installation scenarios, even in the tightest of spaces. Despite passive cooling, the C6015-0010 is suitable for a temperature range up to +55 °C. Moreover, with a mounting space of just 82 x 82 x 40 mm, it is more compact than the previous C6905 series IPCs by a factor of three. With 30 GB 3D MLC M.2 SSD storage and Windows Embedded Compact 7 operating system, it is fully operational in the basic configuration. Windows 7 or Windows 10 operating systems are optionally available.

The Industrial PC offers the following benefits:

- fanless Industrial PC for space-saving control cabinet installation
- mounting sheet at the rear wall
- flexible mounting mechanism for the free alignment of the connecting area
- all connectors on the same level
- Status LEDs
- lithium battery and 1 slot for one 30-GB-M.2-SSD, 3D flash easily accessible
- protection class IP20
- operating temperature 0...55 °C.

2.2 Appropriate Use

The C6015-0010 is a fanless Industrial PC for space-saving control cabinet installation.



Danger

Risk of explosion!

The Industrial PC must not be used where there is a risk of explosion.

2.3 Access to the connectors

The connectors of the Industrial PC are located at the front side of the housing.

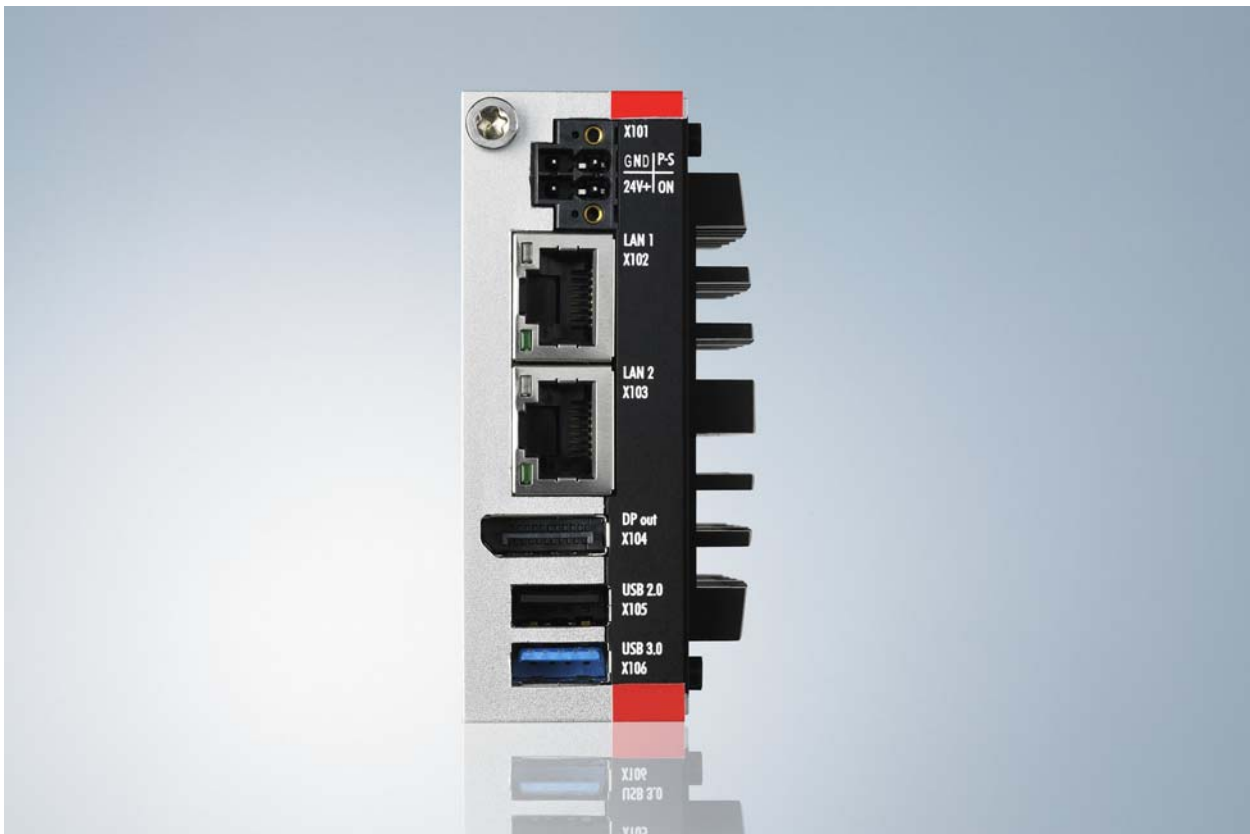

Front view: C6015-0010 without mounting mechanism

2.4 Interfaces

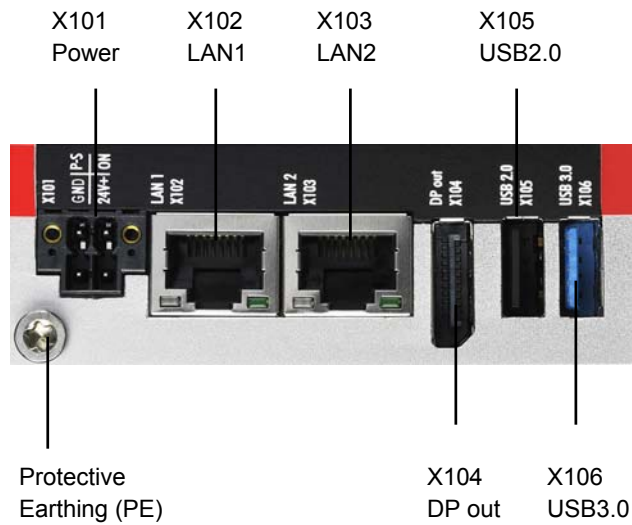

2.4.1 Power Supply (X101)

The power supply for the Industrial PC is established via the socket (**X101**) (see also chapter [Pin assignment of the connector](#)).

The power supply connector is included in delivery.

2.4.2 Network connection LAN1, LAN2 (X102, X103)

The RJ-45 connectors (**X102**, **X103**) allow the PC to be connected to a 100/1000 BASE-T Local Area Network (LAN).

2.4.3 DisplayPort (X104)

The DisplayPort (**X104**) is used for transferring the video signal.

2.4.4 USB2.0 output (X105)

The USB interface (**X105**) is used for connecting peripheral devices with USB connection. USB2.0 standard is supported.

2.4.5 USB3.0 output (X106)

The USB interface (**X106**) is used for connecting peripheral devices with USB connection. USB3.0 standard is supported.

2.4.6 Protective Earthing (PE)

The low-resistance protective earthing of the Industrial PC is established via the screw connection (PE).

 CAUTION	<p>Protective Earthing (PE)</p> <p>The protective conductor connection must not be used for other potentials. “PE” and “0V” (24V system power supply) must be connected to the same potential (connected in the control cabinet).</p> <p>The wiring in the control cabinet must occur in accordance to the standard EN 60204-1:2006 (PELV = Protective Extra Low Voltage).</p> <p>EN 60204-1:2006 part 6.4.1: b): One side of the circuit or one point of the power source must be connected to the protective earth conductor system.</p>
---	---

**CAUTION****Breaking the Power Supply/ Shutting down**

Never disconnect the ground connection when switching off the device. Always disconnect the 24V cable, other wise electricity can still flow due to the screen in dependence of the device.

Any connected devices with its own power supply must have the same potential for "PE" and "GND" like the Panel PC system (no potential difference).

2.5 Access to the battery and the memory device

The battery and the 30-GB-M.2-SSD, 3D flash memory device are located behind a cover at the side of the Industrial PC (1):

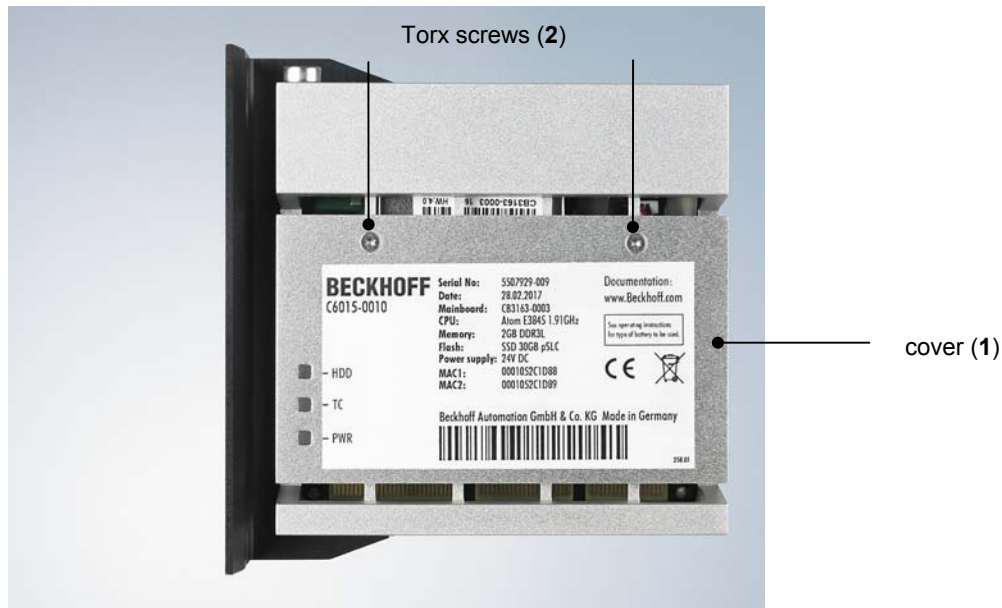

To remove the cover first unloose the two Torx TX6 screws (2). Now you have access to the battery (3) and the memory device (4):

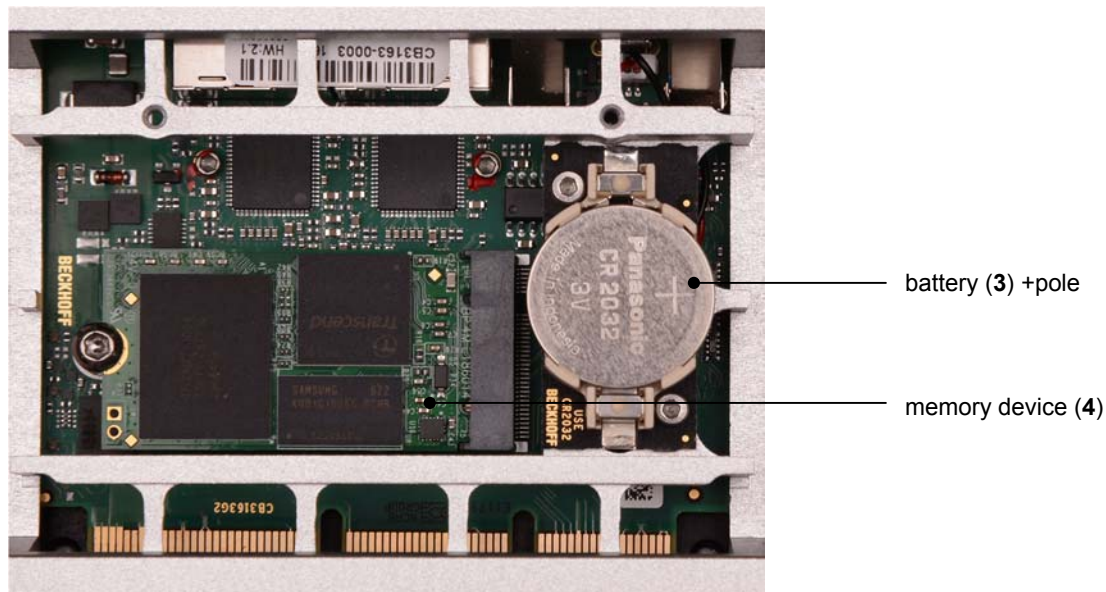

 WARNING	<p>Danger of Explosion!</p> <p>Replace battery only with the identical type or an alternative type recommended by the manufacturer. Notice correct polarity!</p>
---	---

 WARNING	<p>Handling of Batteries</p> <p>Batteries should not be recharged, exposed to fire, opened, short-circuited and they should be protected against sunlight and moisture.</p>
---	--

2.6 Status LEDs

The Status LEDs are located at the side of the C6015-0010:

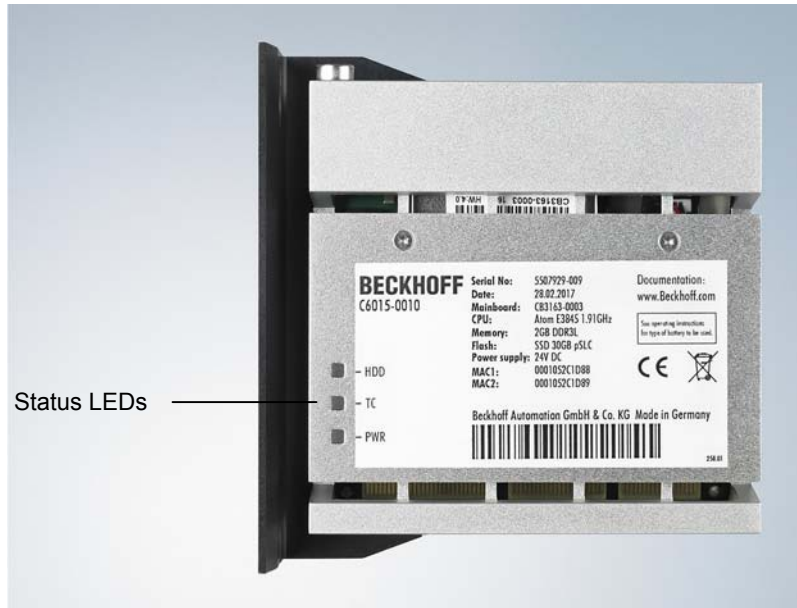

Description of the Status LEDs:

1	HDD (Hard disk):	red	Access to the memory device
2	TC (TwinCAT):	red blue blue/ red blinking green green/ red blinking	TwinCAT Stop TwinCAT Config TwinCAT Config (Fieldbus Error) TwinCAT Run TwinCAT Run (Fieldbus Error)
3	PWR (Power):	green off	Industrial PC is busy Industrial PC is off

3 Installation

3.1 Transport and Unpacking

The specified storage conditions must be observed (see chapter [Technical Data](#)).

3.1.1 Transport

Despite the robust design of the unit, the components are sensitive to strong vibrations and impacts. During transport, your device should therefore be protected from excessive mechanical stress. Therefore, please use the original packaging.

 <p>Attention</p>	<p>Danger of damage to the unit</p> <p>If the device is transported in cold weather or is exposed to extreme variations in temperature, make sure that moisture (condensation) does not form on or inside the device.</p>
---	--

Prior to operation, the unit must be allowed to slowly adjust to room temperature. Should condensation occur, a delay time of approximately 12 hours must be allowed before the unit is switched on.

3.1.2 Unpacking

Proceed as follows to unpack the unit:

1. Remove packaging.
2. Do not discard the original packaging. Keep it for future relocation.
3. Check the delivery for completeness by comparing it with your order.
4. Please keep the associated paperwork. It contains important information for handling the unit.
5. Check the contents for visible shipping damage.
6. If you notice any shipping damage or inconsistencies between the contents and your order, you should notify Beckhoff Service.

3.2 Installation of the PC in the control cabinet

The C6015-0010 Industrial PC is designed for mounting in control cabinets for machine and plant engineering applications. The ambient conditions specified for operation must be observed (see chapter [Technical Data](#)).

3.2.1 Flexible mounting mechanism

The Industrial PC is provided with a flexible mounting mechanism for the free alignment of the connecting area (see also chapter [Assembly dimensions](#)) according to the order option:

Order option	Version
none	Provided with mounting sheet for rear wall installation
C9900-M664	Provided with mounting sheet for side wall installation, instead of sheet at the rear wall
C9900-M665	Mounting sheet for side wall installation of the C6015-0010

The mounting sheets are fastened at the Industrial PC using Torx screws of size TX10.

3.2.2 Preparation of the control cabinet

The holes for the fixing bolts have to be provided in the control cabinet according to the dimensions of the PC (see chapter [Assembly dimensions](#)).

 Note	<p>Circulation of air</p> <p>When the unit is installed in an enclosure, adequate space for ventilation and for opening the PC must be provided.</p> <p>The clearance above and below the housing must be at least 5 cm and laterally at least 2 cm in order to ensure adequate ventilation of the PC.</p>
---	---

 Attention	<p>Avoid extreme environmental conditions</p> <p>Extreme environmental conditions should be avoided as far as possible. Protect the PC from dust, moisture and heat.</p> <p>The ventilation slots of the PC must not be covered.</p>
---	---

3.3 Power Supply of the Industrial PC

The Industrial PC is fitted with a 24 V_{DC} power supply unit.

3.3.1 Pin assignment of the connector

The power supply and the external circuit of the Industrial PC are connected via the 4-pole plug connector (Phoenix DFMC 1,5/2-STF-3,5 BK – 1708595):

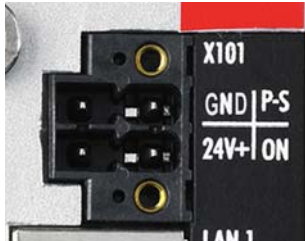

Pin	Function	Pin	Function
GND	0V	P-S	Power-Status Output
24V +	Power Supply	ON	PC_ON Input

 Note	<p>Conductive cross-section</p> <p>The connector is specified for 8 A and can lift conductive cross-sections until 1.5 mm².</p>
--	---

3.3.2 Cable Cross Sections

For the connection of the power supply, wiring with a cable-cross-section of 1.5 mm² must be used.

With bigger distances between voltage source and PC, you take the voltage drop as a function of the cable-cross-section as well as voltage fluctuations of your distribution voltage into account, so that is secured that the voltage doesn't fall under 22 V at the power supply.

 Attention	<p>Insert fuse</p> <p>The power supply must be protected with maximum 16 A.</p>
---	--

3.3.3 Check voltage rating and connect

Fitted with the 24 V_{DC} power supply unit:

1. Check that the external power supply is providing the correct voltage.
2. Insert the power supply cable that you have assembled into the Industrial PC's power supply socket. Then connect it to your external 24 V power supply.

3.3.4 Configuration for shutting down the PC

The connections for shutting down the Industrial PCs are established via the **PC_ON** input and the **Power Status** output.

3.3.5 PC_ON and Power Status functions

- If the **PC_ON** input is connected to 24 V via a switch, the PC shuts down according to the rules. The **PC_ON** signal is inverted, i.e. the PC shuts down if the 24 V connection is live.
- Once the PC has shut down, the **Power Status** output is switched from 24 V to 0 V. Via this output a signal lamp can be connected or a contactor for de-energizing the whole system. The maximum load for the **Power Status** output is 0.5 A and a suitable fuse should be provided.

3.4 Connecting the Industrial PC

 <p>Attention</p>	<p>The mains plug must be disconnected</p> <p>The power supply plug must be withdrawn!</p> <p>Please read the documentation for the external devices prior to connecting them!</p> <p>During thunderstorms, plug connector must neither be inserted nor removed!</p> <p>When disconnecting a plug connector, always handle it at the plug. Do not pull the cable!</p>
---	--

3.4.1 Connecting cables

The connections are located at the rear side of the Industrial PC and are documented in the [Product Description](#) chapter.

When connecting the cables to the Industrial PC, proceed according to the following sequence:

- Switch off all the devices that are to be connected.
- Disconnect all the devices that are to be connected from the power supply.
- Connect all the cables between the Industrial PC and to the devices that are to be connected.
- Connect all data transfer cables (if present) to the appropriate plug-in receptacles of the data/telecommunication networks.
- Reconnect all devices to the power supply.

3.4.2 Check voltage rating and connect

Fitted with a 24 V_{DC} power supply unit:

1. Check that the external power supply is providing the correct voltage.
2. Insert the power supply cable that you have assembled into the Industrial PC's power supply socket. Then connect it to your external 24 V power supply.

3.4.3 Earthing measures

The low-resistance protective earthing of the Industrial PC is established via the screw connection (PE).

Establish a low-impedance connection from the earthing point on the Industrial PC housing (see chapter [Protective Earthing \(PE\)](#)) to the central earthing point on the control cabinet wall, in which the computer is being installed.

4 Operating Instructions

4.1 Switching the Industrial PC on and off

4.1.1 Switch on

The Industrial PC does not have its own mains switch. The Industrial PC will start when the equipment is switched on, or when it is connected to the power supply.

4.1.2 Shutting down and switching off

When the plant is switched off, or when it is disconnected from its power supply, the Industrial PC will be switched off.

Control software such as is typically used on Industrial PCs permits various users to be given different rights. A user who may not close software may also not switch the Industrial PC off, since data can be lost from the hard disk by switching off while software is running.

 Attention	<p>First shut down, then switch off the PC</p> <p>If the Industrial PC is switched off as the software is writing a file to the memory drive, the file will be destroyed. Control software typically writes something to the memory drive every few seconds, so that the probability of causing damage by switching off while the software is running is very high.</p>
---	--

 Attention	<p>Switch off power supply</p> <p>When you have shut down the Industrial PC, you have to switch off power supply for at least 10 seconds before rebooting the system.</p> <p>After resetting power supply the PC will start booting automatically.</p>
---	---

4.1.3 First switching on and driver installation

When you switch on the Industrial PC for the first time, the pre-installed operating system (optional) will be started. In this case, all the required drivers for any additional, optional hardware components ordered with the PC will already have been installed.

If the PC was ordered without operating system, you have to install the operating system and the driver software for any auxiliary hardware yourself. Please follow the instructions in the documentation for the operating system and the additional devices.

4.2 Servicing and maintenance

4.2.1 Cleaning of the Industrial PC

 <p>DANGER</p>	<p>Disconnect power supply</p> <p>Switch off the Industrial PC and all connected devices, and disconnect the Industrial PC from the power supply.</p>
--	--

The device can be cleaned with a soft, damp cleaning cloth. Do not use any aggressive cleaning materials, thinners, scouring material or hard objects that could cause scratches.

4.2.2 Maintenance

The Industrial PC is maintenance-free.

4.2.3 Replacing the Battery on the Motherboard

A used battery on the motherboard has to be replaced. See also chapter [Access to the battery and the memory device](#).

 <p>WARNING</p>	<p>Danger of Explosion!</p> <p>Replace battery only with the identical type or an alternative type recommended by the manufacturer. Notice correct polarity!</p>
---	---

 <p>WARNING</p>	<p>Handling of Lithium Batteries</p> <p>Lithium Batteries should not be recharged, exposed to fire, opened and they should be protected against sunlight and moisture.</p>
---	---

The used battery must be disposed of in accordance with national electronics scrap regulations.

4.3 Emergency procedures

In case of fire, the Industrial PC should be extinguished with powder or nitrogen.

4.4 Shutting down

4.4.1 Disposal

 <p>Note</p>	<p>Observe national electronics scrap regulations</p> <p>Observe the national electronics scrap regulations when disposing of the device.</p>
--	--

In order to dispose of the device, it must be removed and fully dismantled:

- Housing components (polycarbonate, polyamide (PA6.6)) are suitable for plastic recycling
- Metal parts can be sent for metal recycling
- Electronic parts such as disk drives and circuit boards must be disposed of in accordance with national electronics scrap regulations.

5 Troubleshooting

Fault	Cause	Procedure
Nothing happens after the Industrial PC has been switched on	No power supply to the Industrial PC Other cause	Check power supply cable Call Beckhoff Service
The Industrial PC does not boot fully	Setup settings are incorrect Other cause	Check the setup settings Call Beckhoff Service
Computer boots, software starts, but control does not operate correctly	Cause of the fault is either in the software or in parts of the plant outside the Industrial PC	Call the manufacturer of the machine or the software
Memory device access error	Faulty device	Call Beckhoff Service
The Industrial PC functions only partially or only part of the time, e.g. no or dark picture, but disk drive responds when switching on	Defective components in the Industrial PC	Call Beckhoff Service

6 Assembly dimensions

Industrial PC C6015-0010, with mounting sheet for rear wall installation

 Attention	<p>Notice mounting orientation</p> <p>The assembly of the unit must take place with the orientation diagrammed here.</p>
---	---

All dimensions in mm.

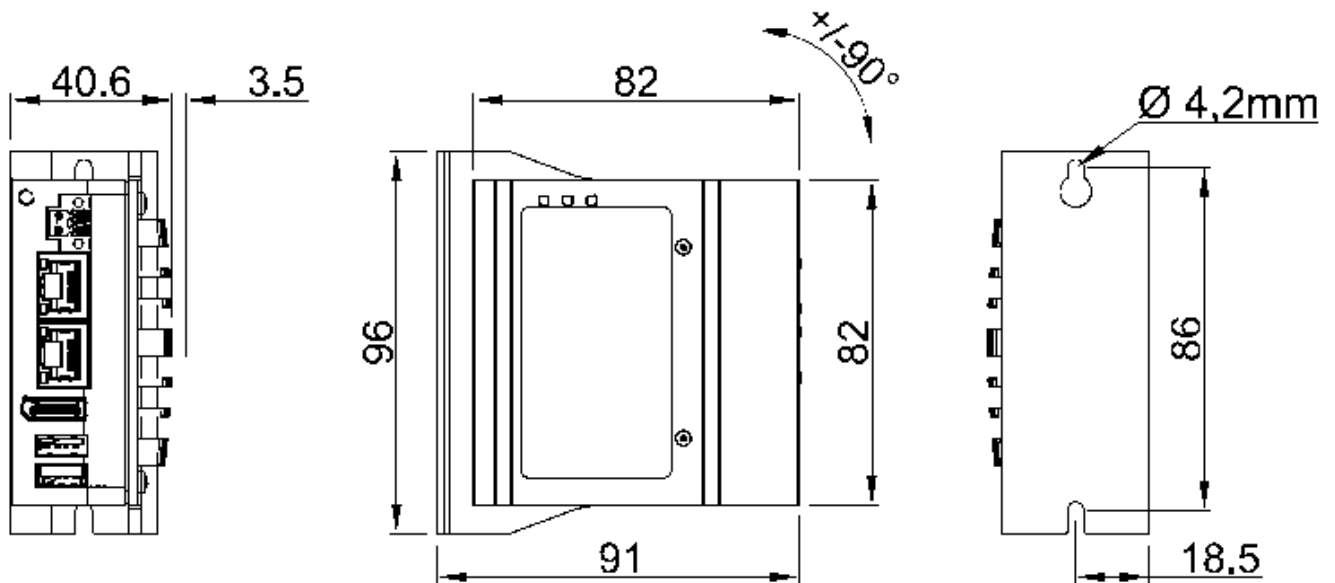
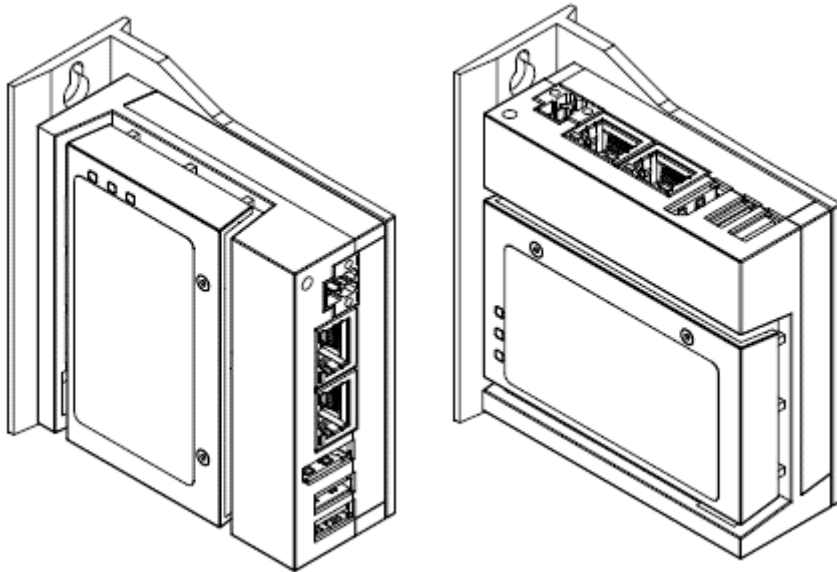

front view

side view

rear view

Industrial PC C6015-0010, with mounting sheet for side wall installation

 Attention	<p>Notice mounting orientation</p> <p>The assembly of the unit must take place with the orientation diagrammed here.</p>
---	---

All dimensions in mm.

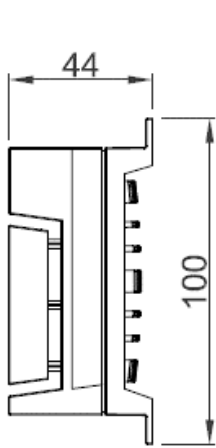

top view

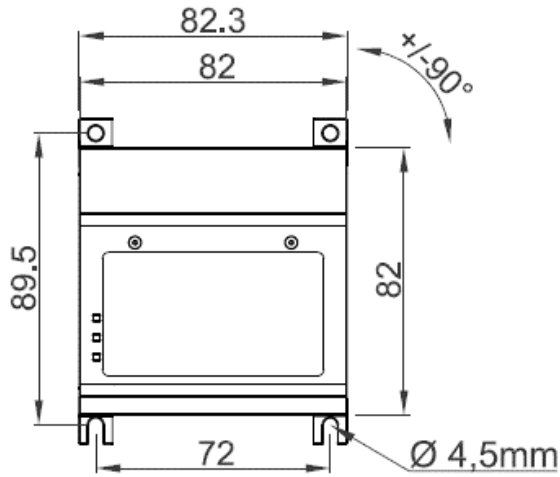

side view

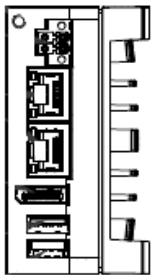
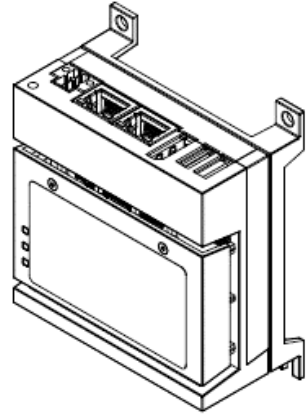

front view

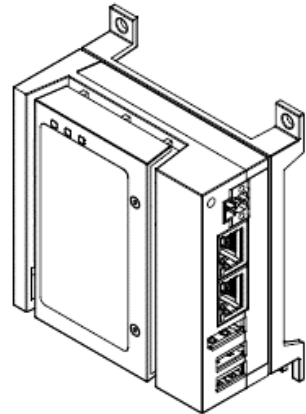

8 Appendix

8.1 Beckhoff Support and Service

Beckhoff and their partners around the world offer comprehensive support and service, making available fast and competent assistance with all questions related to Beckhoff products and system solutions.

8.1.1 Beckhoff branches and partner companies

Please contact your Beckhoff branch office or partner company for [local support and service](#) on Beckhoff products!

The contact addresses for your country can be found in the list of Beckhoff branches and partner companies: www.beckhoff.com. You will also find further [documentation](#) for Beckhoff components there.

8.1.2 Beckhoff company headquarters

Beckhoff Automation GmbH & Co. KG
Huelshorstweg 20
33415 Verl
Germany

Phone: + 49 (0) 5246/963-0
Fax: + 49 (0) 5246/963-198
E-mail: info@beckhoff.de
Web: <http://www.beckhoff.de/>

Beckhoff Support

Support offers you comprehensive technical assistance, helping you not only with the application of individual Beckhoff products, but also with other, wide-ranging services:

- world-wide support
- design, programming and commissioning of complex automation systems
- and extensive training program for Beckhoff system components

Hotline: + 49 (0) 5246/963-157
Fax: + 49 (0) 5246/963-9157
E-mail: support@beckhoff.com

Beckhoff Service

The Beckhoff Service Center supports you in all matters of after-sales service:

- on-site service
- repair service
- spare parts service
- hotline service

Hotline: + 49 (0) 5246/963-460
Fax: + 49 (0) 5246/963-479
E-mail: service@beckhoff.com

If servicing is required, please quote the **project number** of your product.

8.2 Approvals for USA and Canada

8.3 FCC Approvals for the United States of America

FCC: Federal Communications Commission Radio Frequency Interference Statement

This equipment has been tested and found to comply with the limits for a Class A digital device, pursuant to Part 15 of the FCC Rules. These limits are designed to provide reasonable protection against harmful interference when the equipment is operated in a commercial environment. This equipment generates, uses, and can radiate radio frequency energy and, if not installed and used in accordance with the instruction manual, may cause harmful interference to radio communications. Operation of this equipment in a residential area is likely to cause harmful interference in which case the user will be required to correct the interference at his own expense.

 Note	<p>Technical modifications</p> <p>Technological changes to the device may cause the loss of the FCC approval.</p>
--	--

8.4 FCC Approval for Canada

FCC: Canadian Notice

This equipment does not exceed the Class A limits for radiated emissions as described in the Radio Interference Regulations of the Canadian Department of Communications.